

ASSEMBLY INSTRUCTIONS FOR Lawrence Short Pedestal

AR3510-01 1.0

Model # AR3510-01

1.

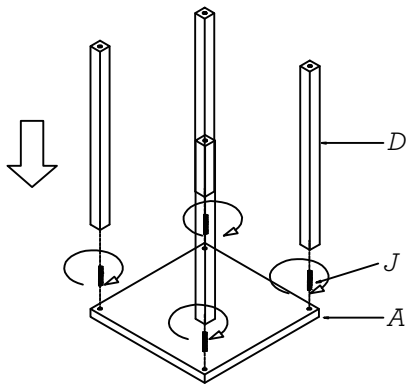

2.

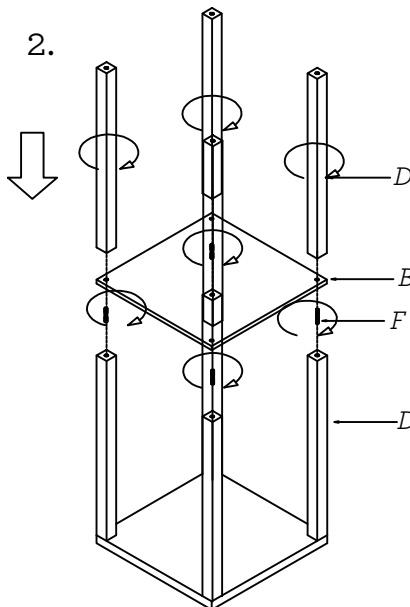

1. Fasten 4 pcs of PART(D) 1 by 1 to PART(A) by PART(J) to tighten .

2. Place PART(B) to bottom 4 pcs of PART(D), fasten with 4 pcs of PART(F) 1 by 1. Screw upper 4 pcs of PART(D) 1 by 1 clockwise to part (F).

3. Place PART(C) to upper 4 pcs of PART(D), fasten with PART(E) and PART(G). Use PART(H) to fasten PART(G). Attach PART(I) to PART(E).





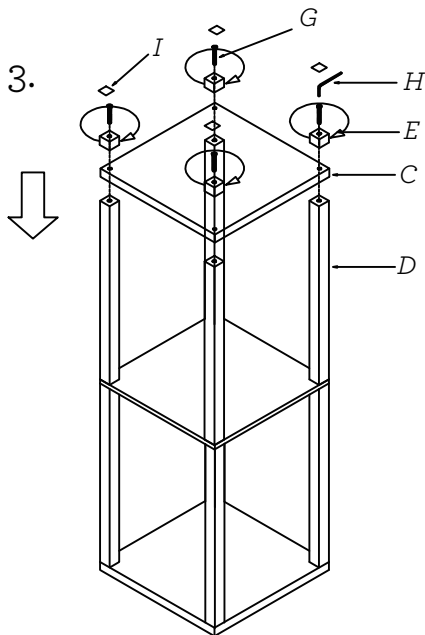

4. Turn the shelf upside down. The shelf is completed.

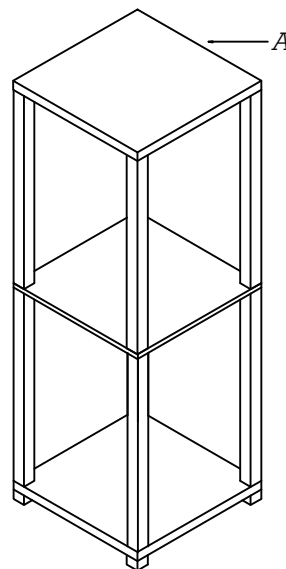
3.

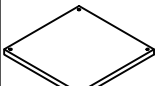
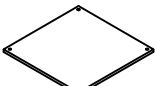
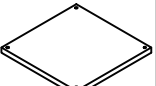
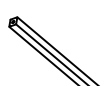

4.



A. Apical Board  1PCS	B. Board  1PCS	C. Bottom Board  1PCS	D. Wood Stick  8PCS	E. Shelf Foot  4PCS
F. Threaded Stem  4PCS	G. Counter Screw  4PCS	H. Wrench  1PCS	I. Felt Pad  4PCS	J. Threaded Stem  4PCS

PARTS DIAGRAM:

(8) Threaded Stems

(4) Felt Pads

(4) Counter Screws