

FIRECLAY TILE



2018 RETAIL PRICE GUIDE

LAST UPDATED: 05-07-18

FIELD TILE

PRODUCT INFORMATION

Price: \$28/SF

Minimum Quantity: 25 SF (\$150 small batch fee if under 25 SF; limit 3 colors)

Patina Finish: Add 30%

Clay Body: White and Recycled

OTHER OPTIONS/FEES

Cuts: Add 30%

Rush Fee: Add 30%

Abrasive Finish: Add \$4/SF (sand or abrasive)

Sheeting: \$5/SF (3x3, 2x4)

Attic Stock: 10–15% overage recommended

Custom Colors:

- \$750 set-up fee (includes one round of feedback)
- Add 30% to SF price; requires 100 SF minimum

TRIM

- Refer to Trim section on page 2

SIZES

- Sizes are not modular
- White and Recycled body are not the same and should not be mixed.

FIELD TILE	SIZE*	PIECES/SF	
		RECYCLED	WHITE
	3 x 3	16	16
	4 x 4	8	8
	6 x 6	4	4
	8 x 8	2.25	
	12 x 12	0.94	
	2 x 4	17	17
	2 x 6	11.5	11.5
	3 x 6	8	8
	2 x 8	8	8
	4 x 8	4.5	4.5
	3 x 9	5.33	5.33
	3 x 12	4	4
	6 x 12	2	

* Sizes are nominal

FOUNDATIONS

PRODUCT INFORMATION

Price: \$15/SF

Minimum Quantity: 25 SF (\$150 small batch fee if under 25 SF; limit 3 colors)

Clay Body: Recycled only

OTHER OPTIONS/FEES

Colors:

White Wash	Moonshine
Tusk	Nickel
Gardenia	French Linen
Oyster Shell	Shetland Wool

Colors are available for purchase in other sizes at other quoted prices. Lead times and minimums correspond to those size requirements.

Attic Stock: 10–15% overage recommended

TRIM

- Refer to Trim section on page 2

SIZES

- Sizes are not modular

FOUNDATIONS	SIZE*	PIECES/SF RECYCLED
	4 x 4	8
	6 x 6	4
	2 x 6	11.5
	3 x 6	8
	4" Hexagon	12



* Sizes are nominal



TILE TRIM

PRODUCT INFORMATION

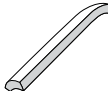
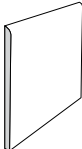
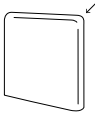
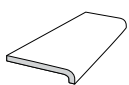
Patina Finish: Add 30%

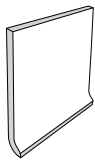
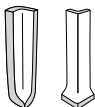
Trim is available in White or Recycled clay bodies.

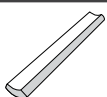
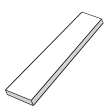
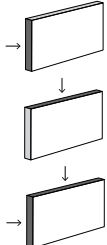
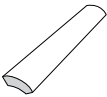
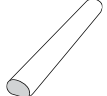
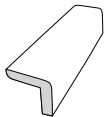
TRIM	SIZE/OPTIONS	PRICE
 AK	1 x 1	\$23/PC
 Beak	5-1/2"	\$16.10/PC
 Bullnose	Available for all field sizes greater than 3 x 3	Price per linear feet by size
 Bullnose Corner	Available for all field sizes greater than 3 x 3	Price per piece by size
 Bullnose-Radius	2-1/2 x 6	\$10.35/PC
	4 x 4	\$13.80/PC
	4 x 6	\$16.10/PC
	6 x 6	\$16.10/PC
 Bullnose-Double Radius	2-1/2 x 6	\$11.50/PC
	4 x 4	\$19.55/PC
	4 x 6	\$24.15/PC
 Cove Base	4 x 4	\$10.35/PC
	4 x 6	\$13.80/PC
	6 x 6	\$16.10/PC
 Cove Outside Corner/ Cove Inside Corner	4"	\$20.70/PC
	6"	\$25.30/PC

TRIM	SIZE/OPTIONS	PRICE
 Finger Cove	4"	\$8.05/PC
	6"	\$10.35/PC
 Flat Liner	6"	\$18.40/LF
	Glazed Long Edge	\$23/LF
	Glazed Short Edge	\$138/LF
 Glazed Edge	Short Side	Price per linear feet by size
	Long Side	
	Corner	Price per piece
 Quarter Round	4"	\$23/LF
	6"	\$17.25/LF
 Round Liner	5/8 x 6	\$20.70/LF
	3/4 x 6	
	1 x 6	
 Square Cap	1-1/2 x 6	\$18.40/PC
 Sink Cap	4"	\$13.80/PC
	6"	\$14.95/PC
 Sink Cap Out	2-3/4 x 1-3/4 x 1-7/8	\$18.40/PC

TILE SHAPES

PRODUCT INFORMATION

Price: \$35/SF

Minimum Quantity: 25 SF (\$150 small batch fee if under 25 SF; limit 3 colors)

Patina Finish: Add 30%

Clay Body: White and Recycled

OTHER OPTIONS/FEES

Cuts: Add 30% per cut

Rush Fee: Add 30%

Abrasive Finish: Add \$4/SF (sand or abrasive)

Attic Stock: 10–15% overage recommended

Custom Colors:

- \$750 set-up fee (includes one round of feedback)
- Add 30% to SF price; requires 100 SF minimum

TRIM

- Refer to Trim section on page 2
- Edge glazing not available for shapes

PATTERNS

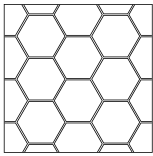

Hexagon

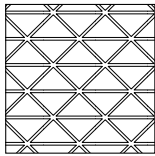

Triangle
Straight Set

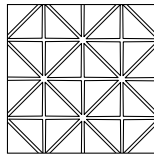

Triangle
Random

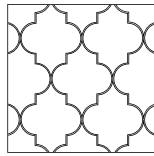

Ogee

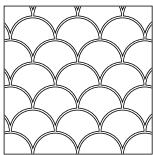

Ogee Drop
Straight Set

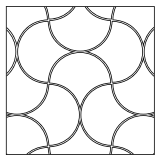

Ogee Drop
Moroccan

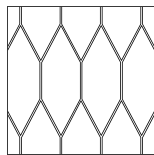

Picket
Straight Set

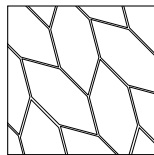

Picket
Braid

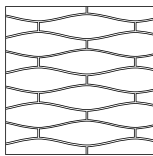

Wave

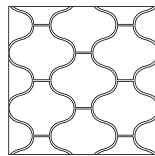

Paseo

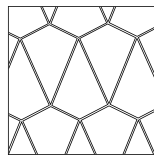

Kite

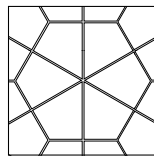

Hexite

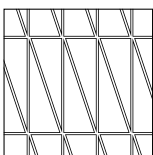

Scalene Triangle

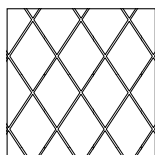

Elongated
Diamond

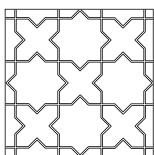

Star & Cross

SHAPES/SIZES

- White and Recycled body are not the same and should not be mixed.

SHAPE	SIZE*	PIECES/SF	
		RECYCLED	WHITE
	3" Hexagon	18	18
	4" Hexagon	12	12
	6" Hexagon	4.75	4.75
	8" Hexagon	2.6	
	12" Hexagon	1.1	
	3" Right Triangle	31	31
	4" Right Triangle	16	16
	6" Right Triangle	7.5	7.5
	Ogee	6.5	6.5
	Ogee Drop	9	9
	Picket	5	5
	Wave	6	6
	Paseo	8.5	8.5
	Kite	7	7
	Hexite	6.5	6.5
	Scalene - Left	9.7	9.7
	Scalene - Right	9.7	9.7
	Elongated Diamond	9	9
	Mini Star & Cross	8	8
	Star & Cross	4.5	4.5

* Sizes are nominal

RUNWAY COLLECTION

PRODUCT INFORMATION

Price: \$50/SF

Minimum Quantity: 25 SF (\$150 small batch fee if under 25 SF; limit 3 colors)

Patine Finish: Add 30%

Clay Body: White and Recycled

***Note:** No engobe for Chaine Femme

OTHER OPTIONS/FEES

Cuts: Add 30%

Rush Fee: Add 30%

Abrasive Finish: Add \$4/SF (sand or abrasive)

Attic Stock: 10–15% overage recommended



Custom Colors:

- \$750 set-up fee (includes one round of feedback)
- Add 30% to SF price; requires 100 SF minimum

TRIM

- Refer to Trim section on page 2
- Edge glazing or Bullnose not available for Runway shapes

SIZES

RUNWAY	SIZE	PIECES/SF	
		RECYCLED	WHITE
	Chaine Femme (no engobe)	19	19
	Chaine Homme	13	13
	Cravate	9	9

PATTERNS

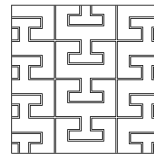

Chaine Femme

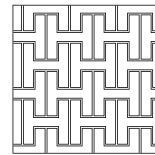

Chaine Homme

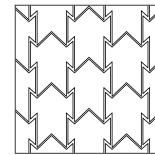

Cravate

TILE MOSAICS

PRODUCT INFORMATION

Price Breakdown:

Blend Options	Price
1-color	\$45/SF (includes sheeting)
2-color blend	\$49/SF (includes sheeting)
3-color blend	\$53/SF (includes sheeting)
4-color blend	\$57/SF (includes sheeting)

Sheeting: All standard layouts come sheeted in a single color or random blend at no additional cost. If a custom layout or specific color pattern is desired, it is an additional \$5/SF.

Minimum Quantity: 25 SF (\$150 small batch fee if under 25 SF; limit 3 colors)

Clay Body: White and Recycled

Note: Not available in patine; engobe not available in 1x1

OTHER OPTIONS/FEES

Cuts: Add 30%

Rush Fee: Add 30%

Attic Stock: 10–15% overage recommended

Custom Colors:

- \$750 set-up fee (includes one round of feedback)
- Add 30% to SF price; requires 100 SF minimum

Murals: Layouts requiring a specific pattern blend will be given custom pricing (minimum quantity of 100 SF).

TRIM

- Refer to Trim section on page 2

SIZES

- White and Recycled body are not the same and should not be mixed.
- Engobe and non-engobe colors should not be mixed.
- For sheet count conversion, see Tile Mosaic Conversion Guide on page 6.

TILE MOSAIC	SIZE*	PIECES/SF	
		RECYCLED	WHITE
	1 x 1	135	135
	2 x 2	34	34
	1 x 4	33	33
	1 x 6	23	23
	2" Hexagon	46	46
	Small Diamond	27	27

* Sizes are nominal

STANDARD LAYOUTS

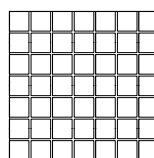

Square Straight Set

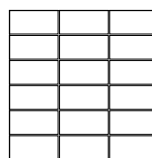

Rectangular Straight Set

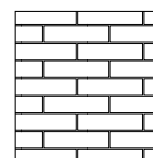

1/2 Offset

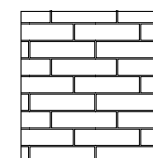

1/3 Offset Staircase

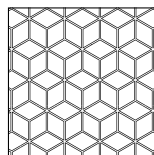

Diamond Escher

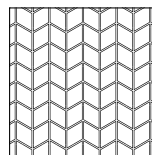

Diamond Stitch

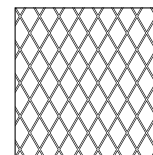

Diamond On Point

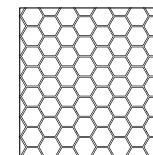

Hexagon Offset

TILE MOSAIC CONVERSION GUIDE

$$\frac{(\text{Total SF} \times \text{Pieces per SF})}{\text{Pieces per Sheet}} = \text{Total Sheets for Order}$$

PRODUCT NAME	BODY	SIZE (SIZES ARE NOMINAL)	PATTERN	SHEET SIZE	PIECES PER SHEET	PIECES PER SQ. FT.*
Tile - Mosaic Sheeted (1 x 1)	Recycled/White	1 x 1	Straight Set	11.75 x 11.75	121	135
Tile - Mosaic Sheeted (2 x 2)	Recycled/White	2 x 2	Straight Set	11.75 x 12	36	34
Tile - Mosaic Sheeted (1 x 4)	Recycled/White	1 x 4	Straight Set	12.875 x 12.25	36	33
Tile - Mosaic Sheeted (1 x 4)	Recycled/White	1 x 4	1/2 Offset	15 x 12.25	36	33
Tile - Mosaic Sheeted (1 x 4)	Recycled/White	1 x 4	1/3 Offset Staircase	15 x 12.5	36	33
Tile - Mosaic Sheeted (1 x 6)	Recycled/White	1 x 6	Straight Set	12.25 x 12.25	24	23
Tile - Mosaic Sheeted (1 x 6)	Recycled/White	1 x 6	1/2 Offset	15.25 x 12.25	24	23
Tile - Mosaic Sheeted (1 x 6)	Recycled/White	1 x 6	1/3 Offset Staircase	16.25 x 12.25	24	23
Tile - Mosaic Sheeted - Hexagon (2")	Recycled/White	2" Hexagon	Offset	12.875 x 11.69	48	46
Tile - Mosaic Sheeted - Small Diamond	Recycled/White	Diamond	Escher	14.63 x 12.25	27	27
Tile - Mosaic Sheeted - Small Diamond	Recycled/White	Diamond	On Point	13.75 x 12.875	25	27
Tile - Mosaic Sheeted - Small Diamond	Recycled/White	Diamond	Stitch	12.75 x 10.875	24	27

* Pieces per square foot includes recommended grout joint of 1/8"

PRICING

Blend Options	Price
1-color	\$45/SF (includes sheeting)
2-color blend	\$49/SF (includes sheeting)
3-color blend	\$53/SF (includes sheeting)
4-color blend	\$57/SF (includes sheeting)

Sheeting: All standard layouts come sheeted in a single color or random blend at no additional cost. If a custom layout or specific color pattern is desired, it is an additional \$5/SF.

Minimum Quantity: 25 SF (\$150 small batch fee if under 25 SF; limit 3 colors)

Clay Body: Available in White and Recycled. White and Recycled bodies are not the same and should not be mixed.

Notes: Upcharge for patine; engobe not available in 1x1

OTHER OPTIONS/FEEES

Cuts: Add 30%

Rush Fee: Add 30%

Attic Stock: 10–15% overage recommended

Custom Colors:

- \$750 set-up fee (includes one round of feedback)
- Add 30% to SF price; requires 100 SF minimum

HANDPAINTED

PRODUCT INFORMATION

Price:

SIZE	PIECES/ SF	PRICE PER PIECE (price determined by size and complexity of design)		
		LEVEL 1	LEVEL 2	LEVEL 3
4x4	9	\$15.00	\$20.00	\$25.00
6x6	4	\$22.50	\$25.00	\$30.00
8x8	2.25	\$30.00	\$35.00	\$45.00
6x12	2	\$32.50	\$37.50	\$47.50

Note: Add \$5.00/PC for custom colorway

Minimum Quantity: 25 pieces (\$150 small batch fee if under 25 pieces)

Finish: Not available in engobe or patine finishes

Body: Recycled clay body only

CUSTOM DESIGN

- \$250 set-up fee (includes two samples)
- Custom orders priced at custom price; requires 25 piece minimum

OTHER OPTIONS/FEES

Rush Fee: 30%

Attic Stock: 10–15% overage recommended

Curved Archways: Quote per project; requires manager approval

Murals: Not available at this time

TRIM

- \$5 per glazed edge on top of per piece pricing
- Bullnose edge: 50% extra per piece

HANDPAINTED DESIGN LEVELS

TILE SIZE	LEVEL 1		LEVEL 2		LEVEL 3	
6x6	Alameda		Avila Barcelona Braga Cordoba Lugo Morris Old California #2	Old California #3 Old California #5 Old California #6 Old California #8 Old California #10 Vigo Vitoria	Almeria Madrid Moorish Knot Old California #1 Old California #4 Old California #7 Old California #9	San Sebastian Santiago Sanxenxo Seville Spanish Cross
8x8	Arable Brook Fallow Grange Grove Harvest	Jardin Fretwork Maze Palmera Pivot Summit Terrain	Diamond Lattice Dolce Ensenito Ginkgo Interlaced Birds Interlaced Leaves Isfahan Jerez Kasbah Trellis Liva C Malta	Old Cairo Padma Persian Star San Carlos Sensu Sintra Starburst Stream Tarragona Tortoise Shell Zuma	Barella Cypress Dragonflies Elephant Star Grandola Murietta Snow Flower Valencia Winter Mountain	
6x12	Mazagan		Diamond Contour Isosceles Marrakech Lace Ripple Uni Mountain		Kabuki Sphere River Rock Woven Grass	

HANDPAINTED FAQ

Below you will find a set of FAQs for placing Handpainted orders:

1. Are there set-up fees for Handpainted tiles?

Yes, there is a \$150 small batch fee for any order under 25 pieces, whether it is standard or custom.

2. What is considered standard custom vs. non-standard custom?

A. Standard Custom = a current Fireclay pattern with a custom colorway & dryline combo.

B. Non-Standard Custom = a custom pattern in a custom colorway. In other words, something we don't have existing artwork for, or something we do have existing artwork for but at a different size than our standard offering.

3. What are the options for ordering standard custom Handpainted tile?

A. Using our online Color-It! tool, you may choose an existing pattern with black dryline and up to 6 glazes from the "Recycled" glaze offering. This excludes any white body glazes, or engobe glazes.

B. If your design requires a line color other than black, white, or medium grey please contact your Fireclay sales rep or Design Consultant.

4. What are the options for ordering non-standard custom Handpainted tile?

A. We require you to submit artwork or pattern reference material.

B. Artwork will be printed on tile sized for standard handpainted collections - 4x4, 6x6, 8x8, 6x12, or other custom size—you must specify the size.

C. We ask for the \$250 set-up fee before any custom work begins.

5. What is included with the non-standard custom set up fee?

A. Artwork production

B. Screen development

C. 2 samples

6. What is a dryline?

Dryline is proprietary formula of oils, waxes and pigments used to "resist" glaze during the painting and firing process of tile which allows for the clearly "outlined" section of each color.

7. What are available dryline colors?

White, Medium Grey & Black. We do not offer custom dryline colors at this time.

8. What is the price?

A. For standard custom - use the standard price for that pattern +\$5

B. For non-standard custom - orders are priced on a project basis. Contact your sales rep or Design Consultant for pricing.

9. What is the sample charge?

A. Standard Custom = \$20/pc

B. Non - standard custom = samples are included as part of set-up fee

Note: Due to the nature of hand applied glazes we cannot guarantee that glaze colors will match across our field and Handpainted tiles.

ARCHITECTURAL MOLDINGS

ARCHITECTURAL MOLDINGS

Price:

- Small: \$17.25/Piece
- Medium: \$23/Piece
- Large: \$28.75/Piece

Minimum Quantity: 25 Pieces (\$150 small batch fee if under 25 pieces)

Patine: Add 30%

















Clay Body: White and Recycled

OTHER OPTIONS/FEES

Rush Fee: Add 30%

Cap: \$5 extra per piece

Corners, Stop Ends & PFC: 100% extra per piece

	NAME	PROFILE	SIZE
SMALL: \$17.25/PC	Ephesus		1 x 6
	Fano		1-1/2 x 6
	Paestum		1 x 6
	Pozzo		1 x 6
	Serilio		1-1/4 x 6
	Sardis		1-1/4 x 6
MEDIUM: \$23/PC	Box Cap		2 x 6
	Cori		2 3/4 x 6
	Cori Cap		2 3/4 x 6
	Marcellus		2 3/4 x 6
	Marcellus Cap		2 3/4 x 6
	Phigalia		2-1/4 x 6
	Polias		2-1/4 x 6
	Polias Cap		2-1/4 x 6
LARGE: \$28.75/PC	Naxian (recycled only)		5 1/4 x 6
	Vassae		4 1/2 x 6

BRICK

PRODUCT INFORMATION

Price: \$18/SF

Minimum Quantity: 25 SF (\$150 small batch fee if under 25 SF; limit 3 colors)

OTHER OPTIONS/FEES

Rush Fee: Add 30%

Abrasive Finish: Add \$4/SF (sand or abrasive)

Attic Stock:

- 3/16" grout line - order 20% overage
- 1/4" grout line - order 16% overage
- 3/8" grout line - order 10% overage

Custom Colors:

- \$750 set-up fee (includes one round of feedback)
- Add 30% to SF price; requires 100 SF minimum

SIZES

BRICK	SIZE	PIECES/SF
	8" x 2-1/2" x 1/2"	6

BRICK TRIM

TRIM	SIZE	PIECES/LF	PRICE
Glazed Edge	Short Side	4.8	\$23/LF
	Long Side	1.5	\$8/LF
	Corner		\$8/PC
Corner	8" L x 2-1/2" W x 1/2" T with a 3-9/16" return		\$12/PC

BRICK NAME TRANSITION

MCNEAR BRICK GLAZE NAME	MUDDOX BRICK NAME
Abyss	Aleutian (V2)
Alcatraz	Rocky Mountains (V2)
Andromeda	Absaroka (V4)
Blue Nebula	Great Smoky (V2)
Ceres	Olympic (V2)
Cotton	White Mountains (V3)
Creme Brulee	Great Plains (V3)
Fog City	Wind River (V2)
Glacier	Klamath (V3)
Graphite	Black Hills (V2)
Grey Heron	Brooks (V3)
Harbor	Allegheny (V4)
Inkwell	Bitterroot (V1)
Luna	Elk (V2)
Mars	Columbia Plateau (V3)
Mercury	Beartooth (V2)
Meteorite	Front Range (V2)
Moss	Green Mountains (V2)
Northwoods	Cascade (V1)
Parakeet	Ozark (V3)
Rust	Adirondack (V2)
Scarlet	Catskill (V2)
Silk	Big Horn (V3)
Snow	Lewis Range (V2)
Stardust	Sierra Nevada (V3)
Supernova	Appalachian (V4)
Vintage Blue	Blue Ridge (V3)
Willow	San Gabriel (V2)

PRODUCT SIZE GUIDE

	RECYCLED (RED BODY)		WHITE BODY		PIECES/LF - LONG SIDE	PIECES/LF - SHORT SIDE
MOSAICS (NOMINAL SIZE)	MOSAICS (ACTUAL SIZE)	PIECES/SF	MOSAICS (ACTUAL SIZE)	PIECES/SF		
1 x 1	15/16" x 15/16"	135	15/16" x 15/16"	135	11	11
1 x 4	15/16" x 4-3/16"	33	15/16" x 4"	33	3	12
1 x 6	15/16" x 6"	23	15/16" x 6"	23	2	12
2 x 2	1-7/8" x 1-7/8"	34	1-7/8" x 1-7/8"	34	6	6
2" Hexagon	1-15/16" x 1-3/4"	46	1-15/16" x 1-3/4"	46	—	—
Small Diamond	2-5/16" x 4"	27	2-5/16" x 4"	27	—	—
FIELD TILE (NOMINAL SIZE)	FIELD TILE (ACTUAL SIZE)	PIECES/SF	FIELD TILE (ACTUAL SIZE)	PIECES/SF	PIECES/LF - LONG SIDE	PIECES/LF - SHORT SIDE
2 x 4	1-15/16" x 4"	17	2" x 4"	17	3	6
2 x 6	1-15/16" x 6"	11.5	1-15/16" x 6-1/16"	11.5	2	6
2 x 8	1-15/16" x 8-1/8"	8	1-15/16" x 8-1/8"	8	1.5	6
3 x 3	2-15/16" x 2-15/16"	16	2-7/8" x 2-7/8"	16	4	4
3 x 6	2-15/16" x 6"	8	2-7/8" x 6"	8	2	4
3 x 9	3" x 9"	5.33	2-7/8" x 8-15/16"	5.33	1.33	4
3 x 12	3" x 12"	4	3" x 12"	4	1	4
4 x 4	4-3/8" x 4-3/8"	8	4-15/16" x 4-15/16"	8	3	3
4 x 8	4-1/4" x 8-1/4"	4.5	4-1/4" x 8-1/4"	4.5	1.5	3
6 x 6	6-1/8" x 6-1/8"	4	6-1/8" x 6-1/8"	4	2	2
6 x 12	6-1/4" x 12"	2	—	—	1	2
8 x 8	8-1/16" x 8-1/16"	2.25	—	—	1.5	1.5
12 x 12	12-1/4" x 12-1/4"	1	—	—	1	1
TILE SHAPES (NOMINAL SIZE)	TILE SHAPES (ACTUAL SIZE)	PIECES/SF	TILE SHAPES (ACTUAL SIZE)	PIECES/SF	PIECES/LF - SHORT SIDE	PIECES/LF - SHORT SIDE
3" Hexagon	3-1/2" x 3-1/2"	18	2-7/8" x 2-7/8"	18	—	—
4" Hexagon	3-7/8" x 3-7/8"	12	3-5/8" x 3-5/8"	12	—	—
6" Hexagon	5-7/8" x 5-7/8"	4.75	5-7/8" x 5-7/8"	4.75	—	—
8" Hexagon	7-7/8" x 7-7/8"	2.6	—	—	—	—
12" Hexagon	12-1/2" x 12-1/2"	1.1	—	—	—	—
Elongated Diamond	5" x 6-1/4"	9	5" x 6-1/4"	9	—	—
3" Triangle	2-15/16" (all three sides)	31	2-7/8" (all three sides)	31	—	—
4" Triangle	4-3/8" (all three sides)	16	4-15/16" (all three sides)	16	—	—
6" Triangle	6-1/8" (all three sides)	7.5	6-1/8" (all three sides)	7.5	—	—
Hexite	6-1/16" x 7-3/32"	6.5	6-1/16" x 7-3/32"	6.5	—	—
Star	7-5/8" x 7-5/8"	4.5	7-5/8" x 7-5/8"	4.5	—	—
Cross	2-1/4" x 7-5/8"		2-1/4" x 7-5/8"			
Mini Star	5-3/4" x 5-3/4"	8	5-3/4" x 5-3/4"	8	—	—
Mini Cross	5-1/2" x 1-5/8"		5-1/2" x 1-5/8"			
Kite	5-1/2" x 7-1/2"	7	5-1/2" x 7-1/2"	7	—	—
Ogee	6-3/4" x 5-1/2"	6.5	6-3/4" x 5-1/2"	6.5	—	—
Ogee Drop	5" x 5-1/4"	9	5" x 5-3/8"	9	—	—
Paseo	4-3/4" x 5-1/2"	8.5	4-5/8" x 5-1/2"	8.5	—	—
Wave	11-1/2" x 2-3/4" x 1-1/16"	6	11-1/2" x 2-3/4" x 1-1/16"	6	—	—
Picket	10-1/4" x 3-3/4"	5	10-1/4" x 3-3/4"	5	—	—
Scalene Triangle - Left or Right	2-7/8" x 9-7/16" x 9"	9.7	2-7/8" x 9-7/16" x 9"	9.7	—	—
Chaine Femme	3-3/8" x 4"	19	3-3/8" x 4"	19	—	—
Chaine Homme	4-1/8" x 4-1/8"	13	4-1/8" x 4-1/8"	13	—	—
Cravate	3-7/8" x 6-1/4"	9	3-7/8" x 6-1/4"	9	—	—

Note: Pieces per square foot includes recommended grout joint of 1/8"

PRODUCT SIZE GUIDE

EDGE (NOMINAL SIZE)	RECYCLED (RED BODY)		WHITE BODY		PIECES/LF - SHORT SIDE	PIECES/LF - SHORT SIDE
	EDGE (ACTUAL SIZE)	PIECES/SF	RUNWAY (ACTUAL SIZE)	PIECES/SF		
3 x 18	3" x 18"	2.67	—	—	0.67	4
6 x 18	6" x 19"	1.33	—	—	0.67	2

BRICK	BRICK (ACTUAL SIZE)	PIECES/SF
Brick Flat	8" L x 2-1/2" W x 1/2" T	6
Standard Corner	8" L x 2-1/2" W x 1/2" T with a 3-9/16" return	—

SAMPLES

STOCK SAMPLES - 2 X 4 COLOR SAMPLES (TILE OR BRICK)

United States

- 5 free + \$5 shipping
- \$2 for each additional thereafter
- Free for Trade always

Canada

- 5 free + \$20 shipping
- \$2 for each additional thereafter
- Free for Trade + \$20 shipping

Shipping: ships within 1–2 business days

STANDARD SAMPLES

- Made to order combine standard colors and standard sizes (i.e. "Tusk on 3 x 6"). This could be Tile or Brick.
- Handpainted for standard patterns and motifs are \$20.
- Ships within 1–3 weeks (use this as a lead time reference for customers).
- Price at per SF price (this could be Tile or Brick).

CUSTOM SAMPLES

- Samples made to order that are fully custom (i.e. custom colors or sizes or something else entirely).
- Requires Custom Form and possibly Construction Card
- Should ship within ideally 2 weeks
- See custom pricing

SWATCH BOXES

- An assortment of product lines for Trade available in Neutrals, Greens, Blues, or Brights
- \$40 for purchase

CHIP KITS

- Available for Tile and Brick

SHIPPING

- USPS Express - delivers in 2–3 days
- FedEx Ground - delivers in 5 days (East Coast); 1 day (CA)
- Can be expedited via FedEx
 - Requires approval from manager or
 - FedEx number from customer

SHIPPING & PAYMENT

PAYMENT METHODS

Payment

We accept all forms of payment including check, eCheck, or credit card (Visa, Mastercard, American Express, or Discover). Because every product is custom made and we adhere to aggressive lead times, production will begin as soon as you place your order. Therefore, we will be required to collect the full balance up-front or charge your credit card as soon as you place your order. Because we offer the very best pricing in all situations, our pricing is based off a cash transaction, so additional credit card fees may apply.

- We are a small business and prefer e-check on all orders.
- For credit card payments, a convenience fee will be applied to your order.
- If a volume discount has been applied to your order, we will only accept payment via check or eCheck. If you want to pay with a credit card, a 1.8% convenience charge will be applied.
- If other terms are required please contact your salesperson directly.

Order Modifications

Because each order is custom made, we cannot change it once it has gone into production. If you do have a change, please contact us immediately to see if we can help resolve the matter quickly.

Add-On Orders

In the event that you need additional tile, you will have 30 days to request an Add-On from the time you receive your original order. For orders under 25 SF a small batch fee will apply.

- We require a control sample of your original tile order to begin production. We are happy to send you a return shipping label for sample submission.
- Please return the sample to the below address and reference your original order number, account name, and Fireclay Tile contact person:

Fireclay Tile Factory
521 Quarry Road
Aromas, CA 95004

- Due to the handcrafted nature of our tile, we are unable to guarantee that the color or sizing will be an exact match to your original order. However, we will do everything we can to make sure your Add-On is within range of your original order.
- Standard quoted lead times will apply to Add-On orders. If you need your Add-On order sooner than the quoted lead time, we may be able to accommodate depending on production availability. A Rush Fee will be applied.

Returns

Because every product is custom made, we cannot allow straight returns. However, if you are unhappy with your selection and it has not yet been installed, we can offer you up to 50% off a different item. Our philosophy is simple—if you are not happy with the product, we will work with you until you are.

Historical Reproductions

We will consider this for very large projects of at least 250 SF or a budget of at least \$20,000. However, for most projects we will not be the right company to handle your residential historical reproduction need.

SHIPPING

- Shipping will happen by either package service (FedEx/UPS) or via LTL freight carrier.
- Shipping estimates will be quoted at the time of order and may be modified if the actual shipping cost varies upon the final shipment.
- Upon ordering, we will need a ship to address and onsite contact information (name and phone number). We cannot process your order until this information has been provided. *Please note Fireclay Tile is not responsible for any redelivery fees incurred during the shipping process or additional accessorial charges (liftgate, difficult to reach or restricted areas) not discussed at the time of order.*
- Shipping charges are based on the following:
 - Weight of material
 - Destination zip code
 - Address type: Residential or Commercial
 - Liftgate: Shipping is quoted as curbside on truck unless a liftgate is requested. Additional charges may apply.
 - Difficult to reach or restricted areas
 - For commercial orders that require multiple pallets a \$12 pallet/crate fee will apply

Redelivery

If there is a redelivery request, you will be charged the corresponding amount charged to us by the freight carrier. Similarly, residential deliveries that were previously listed as a business address will be charged a Residential Redress Fee depending on what we are billed. To avoid these fees, please make sure your shipping information is accurate and up-to-date before placing your order.

SHIPPING & PAYMENT (CONT.)

International Shipping

We will provide shipping quote for international orders. Customs duties paid by customer. We can provide a freight quote for Alaska, Hawaii, International, and Commercial orders once the order has been placed.

Expedited Shipping

We will inquire about the shipping company's extra charges for expedited shipment and will charge you the difference. Please note we do not profit from expedited freight fees and only charge you what is charged by the shipping company.

Split/Consolidated Shipments

Because we process so many shipments a month and each order is made to order, we are unable to split or consolidate shipments.

• **THE FIRECLAY PROMISE** •

Love your tile or we'll make it right.
We've got you covered.

TRADE PROGRAM

We've been working closely with the trade for decades to provide both residential and commercial spaces with beautiful, handcrafted tile. Our experienced Trade Experts are here to help you execute your project efficiently and flawlessly. As an industry professional, you can expect:

- Free Samples
- Volume Pricing
- Complimentary Design Services
- LEED Credits
- 360° Customization

COMMERCIAL PRICING

Many variables factor into pricing of large projects, so we customize pricing for each commercial tile project, ensuring you get the best price possible.