

Radiant Heating & Snow Melting Solutions

Commercial & Residential Hydronic & Electric Products



Radiant made easy

This consolidated North American catalog is intended to provide you with a comprehensive overview of our North American offering. It is intended to be used in conjunction with the Watts Radiant Price list. The catalog has detailed information and images while the associated price guides for the US and Canada reflect current pricing on all Watts Radiant products.



The sections of this catalog have been consolidated for ease of use. All radiant heating and snow melting tubing types are now in one section starting with a comparison chart. The fittings section is now consolidated as well.

New to the US market, Watts Radiant offers ThermalPro™ Mechanical Stations on page 53. Also new to this addition are the SunStat® controls on page 73.

For more information or design help, visit us at:

WattsRadiant.com (USA) or **WattsRadiant.ca (Canada)**

Tubing		pg
RadiantPERT		5
RadiantPEX and RadiantPEX+		6
Onix		7
RadiantPEX-AL		8

Fittings		pg
RadiantPEX+ & RadiantPERT	CrimpRings	10
	CinchClamps	10
	SST20 fittings	11
	Crimp fittings	11
	Compression coupling kits	14
RadiantPERT	F1960 cold expansion fittings	14
Onix	SelfTite and TorqueTite clamps	16
	SST20 Onix swivel fittings	16
	Onix barb / sweat fittings	16
	SelfTite & TorqueTite repair kits	17
	Onix couplings	17
	Mini Ball and balancing	17
RadiantPEX-AL	Compression fittings	18
	Extra insulators	19
	Extra O-rings	19

Manifolds		pg
Stainless Steel	1" and Hi flow	21
	Accessories	23
Custom Copper Tubular		27
CustomCut	Onix	28
	PEX	28
	Pex-Al	29
	CopperStub	29
Copper Manifold Accessories	Vent-and-purge, ball valves, unions	30
	End assemblies	30
	Pressure test kits	31
	Manifold boxes & mounting brackets	31

Insulated Piping		pg
R-flex	Coils	33
	Accessories	35

Fasteners and Tools		pg
Stapler, clips, plates, cable ties, bend supports, unwinder, crimp tools, heat transfer plates, etc.		38

Above Floor Systems		pg
SmartTrac Panels		44

Hydronic Controls		pg
Thermostats, mixing controls and sensors		46
Zone Valve/Actuator		47
Snow Melting		48

Hydronic Accessories		pg
Flow Control	IsoTherm pump and mixing	49
	Pressure differential	49
	Zoning, air removal, mixing	50
Gauges	Pressure and temperature	51

Pre-built Mechanical Panels		pg
ThermalPro	Boiler stations & accessories	53
	Zoning and mixing solutions	56
HydroControl	Custom panels and skids	63

Electric Radiant		pg
Radiant Heating	TapeMat, Custom TapeMat, ShowerMat	65
	WarmWire	68
	HeatMatrix Uncoupling Membrane	70
	UnderFloor Mat	71
	SlabHeat	72
	SunStat Thermostats & Relays	73
	Accessories	74
ProMelt Snow Melting	Mat	76
	Cable	78
	Controls	80
	Accessories	82



Tubing for any application

RadiantPERT

RadiantPEX+

Onix

RadiantPEX-AL

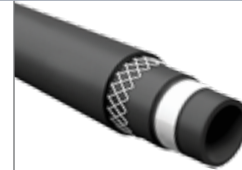

	RadiantPERT	RadiantPEX+	Onix	RadiantPEX-AL
Applications	Under floor	•	•	•
	Staple up	-	-	•
	In-slab radiant heating	•	•	•
	Above subfloor in SmartTrac™	•	•	-
	Snow melt in sand with pavers	•	•	•
	Snow melt in concrete slab	•	•	•
Properties	Distribution piping	-	•	•
	Cold weather installation	•	-	•
	Kink-proof	-	-	•
	Holds shape for easy install	-	-	-
Oxygen barrier	•	•	•	•
Ratings	180°F @ 80 psi, 73.4 °F @ 160 psi	200°F @ 80 psi, 180°F @ 100psi, 73.4°F @ 160 psi	180°F @ 100 psi	200°F @ 100 psi, 180°F @ 125 psi, 140°F @160 psi, 73°F @ 200 psi
Min. bend radius	3/8" tubing	2.5"	4"	3"
	1/2" tubing	3.1"	5"	4"
	5/8" tubing	3.85"	6"	5"
	3/4" tubing	4.4"	7"	6"
	1" tubing	5.6"	9"	8"
Available fittings	ASTM F1960 cold expansion	•	-	-
	Cinch clamps	•	•	-
	Crimp rings	•	•	-
	Compression	•	•	•
	SelfTite Clamps	-	-	•
	TorqueTite Clamps	-	-	•



RadiantPERT™

Polyethylene Raised Temperature Tubing with Oxygen Barrier

PE-RT stands for Polyethylene Raised Temperature. RadiantPERT is a 5-layer PE-RT (polyethylene raised temperature) tubing used for radiant heating, cooling, snow melting, and distribution piping. RadiantPERT is manufactured with Dowlex™ 2344, which offers high strength, high temperature resistance, and long life without cross-linking.

RadiantPERT is the next step in the evolution of flexible plastic pipe and is the strongest flexible pipe on the market today when compared to alternative materials.

RadiantPERT offers the greatest range of fitting flexibility:

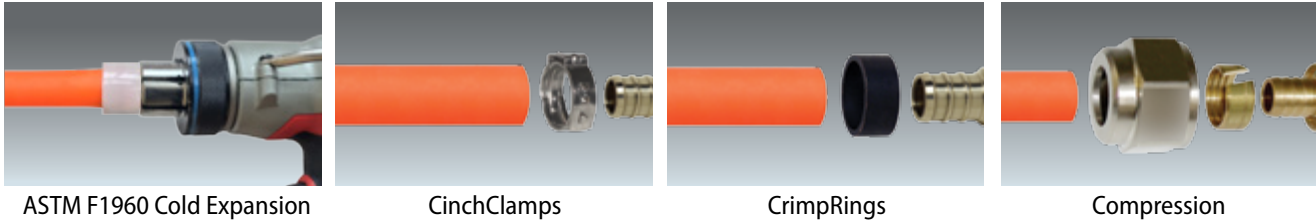

Superior Protection

RadiantPERT is manufactured with an integral ethylene vinyl alcohol (EVOH) DIN Standard O₂ barrier that limits oxygen diffusion through the walls of the tubing.

The outer layer of RadiantPERT adds several benefits:

- Easier to pull through joists
- Reduces expansion noise in walls and floors
- Protects the oxygen barrier from job-site abuse
- Protects the oxygen barrier against moisture

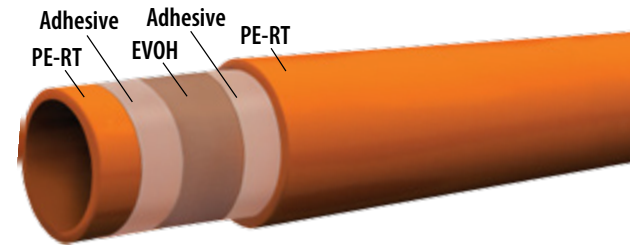

Description	Model #	Order#	lbs.
3/8" RadiantPERT x 600' Coil	PT032061-600	81016322	25
1/2" RadiantPERT x 300' Coil	PT032081-300	81016323	16
1/2" RadiantPERT x 1000' Coil	PT032081-1000	81016324	54
5/8" RadiantPERT 20' sticks, bundle of 25	PT032101-20	81019671	51
5/8" RadiantPERT x 100' Coil	PT032101-100	81019452	8
5/8" RadiantPERT x 300' Coil	PT032101-300	81019453	23
5/8" RadiantPERT x 500' Coil	PT032101-500	81016325	38
5/8" RadiantPERT x 1200' Coil	PT032101-1200	81016326	91
3/4" RadiantPERT 20' sticks, bundle of 25	PT032121-20	81016357	51
3/4" RadiantPERT x 300' Coil	PT032121-300	81016327	31
3/4" RadiantPERT x 500' Coil	PT032121-500	81016328	51
3/4" RadiantPERT x 1200' Coil	PT032121-1200	81016329	122
1" RadiantPERT 20' sticks, bundle of 5	PT032161-20	81016358	18
1" RadiantPERT x 300' Coil	PT032161-300	81016330	50

All RadiantPERT carries a 25-year warranty for residential and commercial heating and snow melting applications.

Codes, Listings and Standards

RadiantPERT is certified to ASTM F2623 for Polyethylene of Raised Temperature (PE-RT) SDR 9 Tubing by NSF and CSA. This standard includes requirements and testing methods for materials, workmanship, dimensions, sustained hydrostatic pressure strength, and bend strength.

RadiantPERT meets or exceeds these standards.

- Tested and listed to NSF-14 (rfh) and NSF U.M. Code
- Maximum operating temperature and pressure:
 - 160 psi at 73°F, 80 psi at 180°F
- ICC rfh
- CSA ASTM F2623
- PPI TR-4 listing at 73°F and 180°F
- Certified to the Uniform Mechanical Code by NSF.



RadiantPEX+

Cross-linked Polyethylene Tubing w/EVOH Barrier

Superior Protection

All 3/8" through 1" Watts RadiantPEX+ has an outer layer for superior protection. This outer layer adds several benefits:

- Easier to pull through joists
- Reduces expansion noise in walls and floors
- Protects the oxygen barrier from job-site abuse

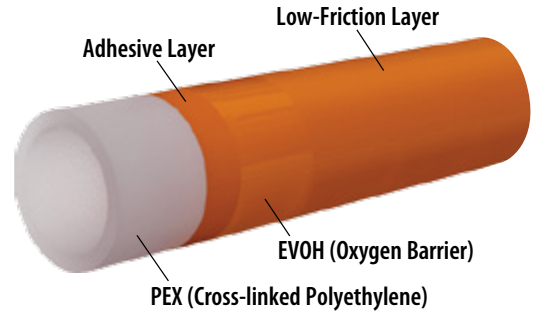

RadiantPEX+ and RadiantPEX have a 25-year warranty for residential and commercial heating and snow melting applications.



Description	Model #	Order#	lbs.
3/8" RadiantPEX+ x 600' Coil	PB032061-600	81000850	26
1/2" RadiantPEX+ custom length coil*	PB032081-1	81010820	-
1/2" RadiantPEX+ x 100' Coil	PB032081-100	81001680	6
1/2" RadiantPEX+ x 250' Coil	PB032081-250	81010945	15
1/2" RadiantPEX+ x 300' Coil	PB032081-300	81003406	17
1/2" RadiantPEX+ x 500' Coil	PB032081-500	81009710	25
1/2" RadiantPEX+ x 600' Coil	PB032081-600	81001682	27
1/2" RadiantPEX+ x 1000' Coil	PB032081-1000	81001681	55
5/8" RadiantPEX+ custom length coil*	PB032101-1	81010815	-
5/8" RadiantPEX+ x 300' Coil	PB032101-300	81009852	27
5/8" RadiantPEX+ x 400' Coil	PB032101-400	81010946	35
5/8" RadiantPEX+ x 500' Coil	PB032101-500	81009711	43
5/8" RadiantPEX+ x 600' Coil	PB032101-600	81001684	51
5/8" RadiantPEX+ x 1000' Coil	PB032101-1000	81010947	89
5/8" RadiantPEX+ x 1200' Coil	PB032101-1200	81001683	102
3/4" RadiantPEX+ custom length coil*	PB032121-1	81010819	-
3/4" RadiantPEX+ x 100' Coil	PB032121-100	81001685	11
3/4" RadiantPEX+ x 300' Coil	PB032121-300	81005303	27
3/4" RadiantPEX+ x 500' Coil	PB032121-500	81001687	44
3/4" RadiantPEX+ x 600' Coil	PB032121-600	81001688	53
3/4" RadiantPEX+ x 1000' Coil	PB032121-1000	81009868	88
3/4" RadiantPEX+ x 1200' Coil	PB032121-1200	81001686	106
3/4" RadiantPEX+ x 20' (bundle of 25 sticks)	PB032121-20	81007368	42
1" RadiantPEX+ custom length coil*	PB032161-1	81010965	-
1" RadiantPEX+ x 100' Coil	PB032161-100	81004923	18
1" RadiantPEX+ x 300' Coil	PB032161-300	81009361	26
1" RadiantPEX+ x 600' Coil	PB032161-600	81002954	107
1" RadiantPEX+ x 20' (bundle of 5 sticks)	PB032161-20	81007367	16

* Custom coil minimum order quantity must be 10,000 ft. Please allow 4-6 week lead time.

4 Layer RadiantPEX+	1-1/4" RadiantPEX x 100' Coil	PB032181-100	81009109	26
	1-1/4" RadiantPEX x 300' Coil	PB032181-300	81009110	73
	1-1/4" RadiantPEX x 20' sticks (bundle of 5)	PB032181-20	81009118	24
	1-1/2" RadiantPEX x 100' Coil	PB032201-100	81009994	32
	1-1/2" RadiantPEX x 300' Coil	PB032201-300	81009995	95
3 Layer RadiantPEX	1-1/2" RadiantPEX x 20' sticks (bundle of 5)	PB032201-20	81009993	32
	2" RadiantPEX x 100' Coil	PB032221-100	81010853	43
	2" RadiantPEX x 300' Coil	PB032221-300	81010854	129
	2" RadiantPEX x 20' sticks (bundle of 5)	PB032221-20	81010855	43

Codes, Listings and Standards

RadiantPEX+ and RadiantPEX are manufactured to American Standard Testing Methods (ASTM F-876 and F-877) and to SDR9 dimensions. These standards include requirements and testing methods for materials, workmanship, dimensions, environmental stress cracking, sustained hydrostatic pressure strength, bend strength, and degree of cross-linking.

RadiantPEX and RadiantPEX+ meet or exceed these standards.

- NSF-14 (rffh)
- ASTM E-84 (Standard Test Method for Surface Burning Characteristics of Building Materials)
- UL 263 (Fire Tests of Building Construction and Materials)
- International Code Council Evaluation Service (ICC) to Report #ESR-1155, and PMG-1008 which give compliance to IPC, IMC, UMC, and UPC, and CSA Standard B137.5.

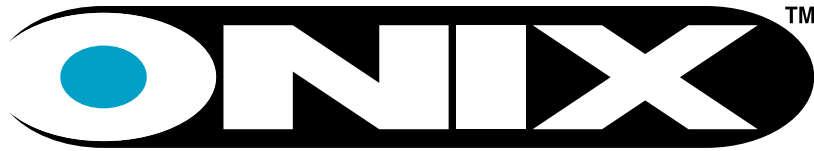

Professional Grade Radiant Tubing

Onix is an EPDM-based, aramid fiber reinforced tube with an aluminum oxygen barrier. Its unmatched flexibility and durability make Onix the best tubing for underfloor radiant, cold weather installations, and snow melt.

- Proven in tens of thousands of installations across North America.
- Easy-to-install at any temperature, cutting installation times by as much as 50%!
- Onix does not expand or contract, and will never make any noise.
- Onix has excellent UV resistance.
- Onix is not damaged by kinking.

Unlike PEX, Onix does not expand and contract and it always stays in contact with the subfloor, making it ideal for underfloor applications.

Underfloor radiant lets builders construct a home the way they normally do, without pouring concrete, double plating, or other special considerations that can stop a radiant project in its tracks.

With remodels on the rise, Onix is a great way to tap into this growing market. You can easily snake Onix through floor joists, around nails, piping, ducts and other obstacles you're sure to find in a remodel project.

Standard Onix Coils — Oxygen barrier tubing for radiant heating, snow melting, and supply & return piping.

Description	Model #	Order#	lbs.
3/8" Onix x 160' Coil	086061-160	81001558	29
3/8" Onix x 180' Coil	086061-180	81001559	32
3/8" Onix x 200' Coil	086061-200	81001560	36
3/8" Onix x 600' Spool	086061-600	81001565	108
1/2" Onix x 200' Coil	086081-200	81001579	46
1/2" Onix x 250' Coil	086081-250	81001582	58
1/2" Onix x 300' Coil	086081-300	81001584	69
1/2" Onix x 400' Spool	086081-400	81001587	92
1/2" Onix x 600' Spool	086081-600	81001590	138
5/8" Onix x 100' Coil	086101-100	81001600	25
5/8" Onix x 200' Coil	086101-200	81001603	50
5/8" Onix x 300' Spool	086101-300	81001605	75
5/8" Onix x 400' Spool	086101-400	81001609	100
5/8" Onix x 600' Spool	086101-600	81001616	150
3/4" Onix x 100' Coil	086121-100	81001627	35
3/4" Onix x 200' Coil	086121-200	81001629	70
3/4" Onix x 300' Spool	086121-300	81001631	105
3/4" Onix x 400' Spool	086121-400	81001634	140

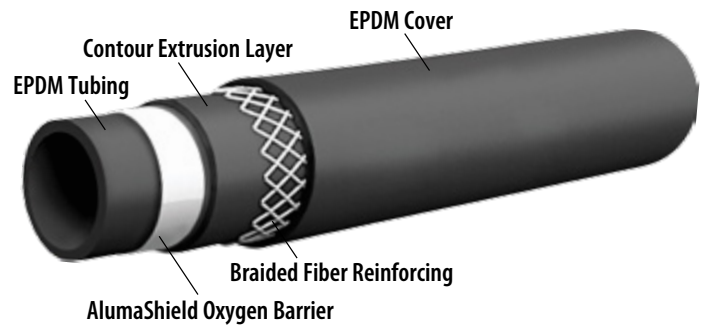

Onix carries a 25-year warranty for residential and commercial heating and snow melting applications.



Codes, Listings and Standards

Onix is tested to relevant portions of several ASTM standards and carries the UPC mark as approved by the International Association of Plumbing and Mechanical Officials (IAPMO).

- Onix with AlumaShield oxygen barrier is rated to 180°F at 100 psi.



RadiantPEX-AL™

Cross-Linked Polyethylene x Aluminum x Cross-Linked Polyethylene

The RadiantPEX-AL Advantage

RadiantPEX-AL is a proven, long lasting composite pipe engineered for radiant floor heating, snow melting, and distribution piping.

- RadiantPEX-AL installs faster than PEX because it holds its shape, even with one installer.
- RadiantPEX-AL has very little expansion/contraction (about 1/8 that of PEX), so it's ideal for "dry" applications or high temperature distribution piping.
- RadiantPEX-AL retains its flexibility in cold temperatures, so it can be easily installed in winter weather.

RadiantPEX-AL Is Built to Last

RadiantPEX-AL pipe and fittings are manufactured to meet or exceed ASTM requirements.

All RadiantPEX-AL Tubing carries a 25-year warranty for residential and commercial heating and snow melting applications.

RadiantPEX-AL Coils — RadiantPEX-AL can be shaped to fit any job-site condition. Use it for all floor heating and snow melting, as well as supply piping for other hydronic applications.

Description	Model#	Order#	lbs.
3/8" x 200' (Coil), RadiantPEX-AL*	RL06-200-OR	81011133	18
1/2" x 300' (Coil), RadiantPEX-AL*	RL0508-300-OR	81010635	23
1/2" x 1000' (Coil), RadiantPEX-AL*	RL0508-1000-OR	81010637	70
5/8" x 300' (Coil), RadiantPEX-AL*	RL10-300-OR	81007605	35
5/8" x 1200' (Coil), RadiantPEX-AL*	RL10-1200-OR	81007606	130
3/4" x 100' (Coil), RadiantPEX-AL*	RL12-100-OR	81007607	18
3/4" x 300' (Coil), RadiantPEX-AL*	RL12-300-OR	81007608	48
3/4" x 500' (Coil), RadiantPEX-AL*	RL12-500-OR	81007609	73
1" x 100' (Coil), RadiantPEX-AL*	RL16-100-OR	81007610	20
1" x 300' (Coil), RadiantPEX-AL*	RL16-300-OR	81007611	54

* Not inventoried in Canada. Special order only.

Codes, Listings, and Standards

Tubing: RadiantPEX-AL is manufactured in accordance with American Standard Testing Methods (ASTM) F-1281-2005, is tested and listed by the National Sanitation Foundation (NSF-rfh), and carries the UPC certification mark, as approved by the International Association of Plumbing and Mechanical Officials (IAPMO).

Fittings: Compression Fittings are tested and listed by NSF (NSF-rfh).
RadiantPEX-AL Warranty

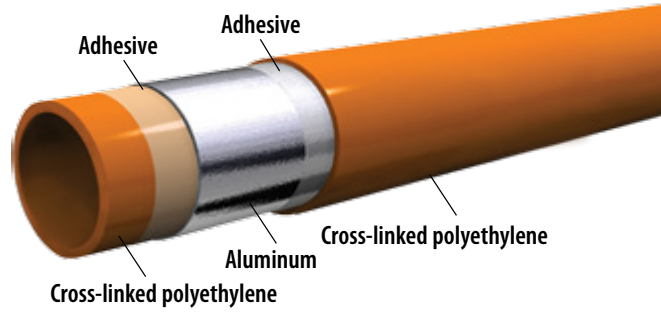

RadiantPEX-AL pipe is constructed with 5 layers, each providing strength, durability, and longevity.



Choose from a complete line of fittings to simplify your next installation. Watts Radiant offers solutions that work with your preferred tools, even in tight, hard to reach spaces.

RadiantPERT

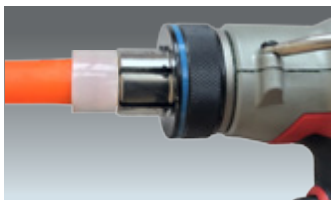

ASTM F1960



Cinch

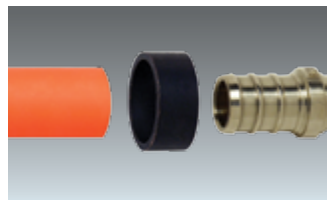

Crimp



SST20 Compression

RadiantPEX+



SelfTite

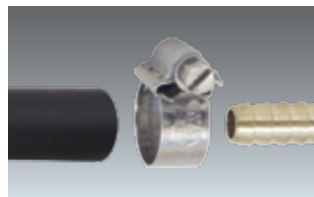

TorqueTite

RadiantPEX-AL

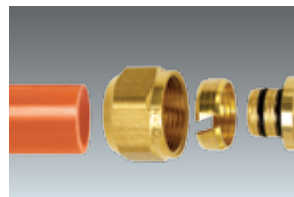

SST20 Compression

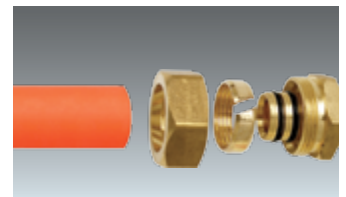

Compression

CrimpRings & CinchClamps



Copper CrimpRings — for securing PEX to brass crimp fittings.

Description	QTY	Model#	Order#	lbs.
3/8" CrimpRing	100	PCCR2X-100	81001071	1.0
1/2" CrimpRing	100	PCCR3X-100	81001075	1.0
5/8" CrimpRing	100	PCCR6X-100	81004508	2.0
3/4" CrimpRing	100	PCCR4X-100	81001080	2.0
1" CrimpRing	100	PCCR5X-100	81001084	3.0
1-1/4" CrimpRing	10	PCCR7X-10	81011152	3.0
1-1/2" CrimpRing	10	PCCR9X-10	81011129	1.0
2" CrimpRing	5	PCCR10X-5	81017116	3.0

Copper CrimpRings are precision-formed, ductile copper connectors. When crimped, these connections form a simple, fast, and permanent seal between PEX and CrimpRing fittings. 1-1/2" CrimpRings require a Power Crimp Tool.

Stainless Steel CinchClamps™ — for fast, easy, one-tool connections.



Description	QTY	Model#	Order#	lbs.
3/8" CinchClamps	10	PCCC2X-10	81004993	1.0
1/2" CinchClamps	10	PCCC3X-10	81004995	1.0
1/2" CinchClamps	100	PCCC3X-100	81004996	1.0
5/8" CinchClamps	10	PCCC6X-10	81005114	2.0
5/8" CinchClamps	100	PCCC6X-100	81005115	3.0
3/4" CinchClamps	10	PCCC4X-10	81004997	2.0
3/4" CinchClamps	100	PCCC4X-100	81004998	3.0
1" CinchClamps	10	PCCC5X-10	81005001	2.0

CinchClamps have been proven in millions of connections.

SST20 Fittings

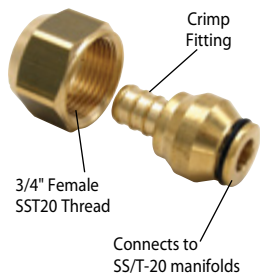

SST20 Crimp Swivel Fittings — for connecting RadiantPEX/RadiantPERT using Cinch Clamps or Crimp Rings to Watts Radiant's Stainless Steel manifolds. **Not** for potable water use.

Description	QTY	Model#	Order#	lbs.
3/8" Crimp x 3/4" SST20 Swivel BSP Fitting	10	PC690001-10	81005160	1.0
1/2" Crimp x 3/4" SST20 Swivel BSP Fitting	10	PC690002-10	81005162	1.0
5/8" Crimp x 3/4" SST20 Swivel BSP Fitting	10	PC690003-10	81005164	2.0
3/4" Crimp x 3/4" SST20 Swivel BSP Fitting	10	PC690004-10	81005395	2.0

Use these SST20 Crimp Fittings to connect RadiantPEX/RadiantPERT to our Stainless Steel Manifolds. Order CrimpRings or CinchClamps separately. BSP Stands for British Standard Pipe (threads). These threads are not compatible with NPT (National Pipe Threads).

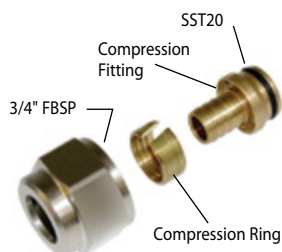

SST20 Compression Fittings — for connecting RadiantPEX/RadiantPERT to Stainless Steel manifolds, or 3/4" male BSP x male sweat fittings. **Not** for potable water use.

Description	QTY	Model#	Order#	lbs.
3/8" PEX Compression x 3/4" SST20 Swivel BSP	10	PX690001-10	81005166	1.0
1/2" PEX Compression x 3/4" SST20 Swivel BSP	10	PX690002-10	81005168	1.0
5/8" PEX Compression x 3/4" SST20 Swivel BSP	10	PX690003-10	81005170	2.0
3/4" PEX Compression x 3/4" SST20 Swivel BSP	10	PX690004-10	81005172	2.0
Replacement BSP O-Ring	1	PX690000	81005279	1.0

SST20 Fittings



SST20 F1960 Fittings – for connecting RadiantPERT™ using F1960 fittings to Watts Radiant Stainless Steel manifolds. **Not** warranted for any tubing other than RadiantPERT.

Description	QTY	Model#	Order#	lbs.
3/8" F1960 X 3/4" SST20 Swivel BSP	10	LFPFB24X-10	81019373	1
1/2" F1960 X 3/4" SST20 Swivel BSP	10	LFPFB34X-10	81019381	1
5/8" F1960 X 3/4" SST20 Swivel BSP	10	LFPFB64X-10	81019387	2
3/4" F1960 X 3/4" SST20 Swivel BSP	10	LFPFB44X-10	81019399	2



PEX Rings (1 per F1960 connection) **Not** warranted for any tubing other than RadiantPERT.

Description	QTY	Model#	Order#	lbs.
3/8" Pex Ring	10	PFS2-10	81019400	1
1/2" Pex Ring	10	PFS3-10	81019401	1
5/8" Pex Ring	10	PFS6-10	81019402	1
3/4" Pex Ring	10	PFS4-10	81019403	1

Crimp Fittings



Male Sweat

Crimp x Male Sweat Adapters — for connecting RadiantPEX/RadiantPERT to sweat fittings or manifolds.

Description	QTY	Model#	Order#	lbs.
3/8" Crimp x 1/2" LF Male Sweat Adapter	10	LFPC637X-10	81016908	0.3
1/2" Crimp x 1/2" LF Male Sweat Adapter	10	LFPC650X-10	81016909	0.5
5/8" Crimp x 1/2" Male Sweat Adapter	10	PC660X-10	81003685	1.0
5/8" Crimp x 3/4" Male Sweat Adapter	10	PC670X-10	81003427	1.0
3/4" Crimp x 3/4" LF Male Sweat Adapter	10	LFPC675X-10	81016910	0.8
1" Crimp x 1" LF Male Sweat Adapter	10	LFPC700X-10	81016911	0.8
1 1/4" Crimp x 1 1/4" LF Male Sweat Adapter	10	LFPC725X-10	81016912	0.9
1 1/2" Crimp x 1 1/2" LF Male Sweat Adapter	1	LFPC795X-10	81016913	0.3
2" Crimp x 2" LF Male Sweat Adapter	1	LFPC115X-10	81016931	0.5

1-1/2" CrimpRings require a Power Crimp Tool. 3/8" - 1" RadiantPEX/RadiantPERT fittings can be used with either Crimp or Cinch connector. 1-1/4" and larger can only be used with Crimp connectors.



Female Sweat

Crimp x Female Sweat Adapters — for connecting RadiantPEX/RadiantPERT to sweat fittings or manifolds.

Description	QTY	Model#	Order#	lbs.
1/2" Crimp x 1/2" LF Female Sweat Adapter	10	LFPC750X-10	81016914	0.6
3/4" Crimp x 3/4" LF Female Sweat Adapter	10	LFPC775X-10	81016915	1.1
1" Crimp x 1" LF Female Sweat Adapter	10	LFPC780X-10	81016916	0.7
1 1/4" Crimp x 1 1/4" LF Female Sweat Adapter	10	LFPC785X-10	81016917	2.0
1 1/2" Crimp x 1 1/2" LF Female Sweat Adapter	1	LFPC790X-10	81016918	0.3
2" Crimp x 2" LF Female Sweat Adapter	1	LFPC110X-10	81017118	0.5

1-1/2" and 2" CrimpRings require a Power Crimp Tool.

Crimp Fittings

Crimp x Male NPT Adapters — for connecting RadiantPEX/RadiantPERT to female fittings and valves.



Description	QTY	Model#	Order#	lbs.
3/8" Crimp x 1/2" LF MPT Adapter	10	LFPCMC23X-10	81016919	1.0
1/2" Crimp x 1/2" LF MPT Adapter	10	LFPCMC33X-10	81016920	0.8
5/8" Crimp x 3/4" MPT Adapter	10	PCMC64X-10	81005385	2.0
3/4" Crimp x 1/2" LF MPT Adapter	10	LFPCMC43X-10	81016922	0.8
3/4" Crimp x 3/4" LF MPT Adapter	10	LFPCMC44X-10	81016923	1.6
1" Crimp x 1" LF MPT Adapter	10	LFPCMC55X-10	81016924	0.7
1 1/4" Crimp x 1 1/4" LF MPT Adapter	10	LFPCMC78X-10	81016925	1.0
1 1/2" Crimp x 1 1/2" LF MPT Adapter	1	LFPCMC99X-10	81016926	0.5
2" Crimp x 2" LF MPT Adapter**	1	LFPCMM110K	81016927	0.8

1-1/2" and 2" CrimpRings require a Power Crimp Tool.

Crimp x Female Sweat Elbow

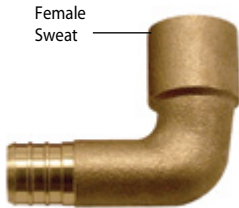

Description	QTY	Model#	Order#	lbs.
1/2" Crimp x 3/4" LF Female Sweat Elbow	10	LFPCE34-10	81016928	1.3
5/8" Crimp x 3/4" Female Sweat Elbow	10	PCE64-10	81004786	3.0
3/4" Crimp x 3/4" LF Female Sweat Elbow	10	LFPCE44-10	81016929	1.6

Use these **Crimp x Sweat Elbow Fittings** to speed the connection of RadiantPEX/RadiantPERT supply lines to baseboard and hydro-air units.

Crimp x Male Sweat Elbow



Description	QTY	Model#	Order#	lbs.
1/2" Crimp x 3/4" Male Sweat Elbow	10	PCE34M-10	81009374	3.0
3/4" Crimp x 3/4" Male Sweat Elbow	10	PCE44M-10	81009378	3.0

Use these **Crimp x Sweat Elbow Fittings** to speed the connection of RadiantPEX/RadiantPERT supply lines to baseboard and hydro-air units.

Crimp x Crimp Elbows (Equal Elbows)



Description	QTY	Model#	Order#	lbs.
1/2" Crimp LF Elbow	10	LFPCE33X-10	81016932	0.8
5/8" Crimp Elbow	10	PCE66X-10	81014904	1.0
3/4" Crimp LF Elbow	10	LFPCE44X-10	81016933	1.3
1" Crimp LF Elbow	10	LFPCE55X-10	81016934	2.1
1 1/4" Crimp LF Elbow	10	LFPCE77X-10	81016935	3.4
1 1/2" Crimp LF Elbow	1	LFPCEC99K	81016936	0.5
2" Crimp LF Elbow	1	LFPCEC110K	81016937	0.9

Crimp x Crimp Tees (Equal Tees)



Description	QTY	Model#	Order#	lbs.
1/2" Crimp LF Tee	10	LFPCT333X-10	81016938	0.6
3/4" Crimp LF Tee	10	LFPCT444X-10	81016939	1.5
1" Crimp LF Tee	10	LFPCT555X-10	81016940	3.0
1-1/4" Crimp LF Tee	10	LFPCT777X-10	81017119	5.0
1-1/2" Crimp LF Tee	1	LFPCT999X-1	81017120	1.0
2" Crimp LF Tee	1	LFPCT111X-1	81017121	1.0

Crimp Fittings

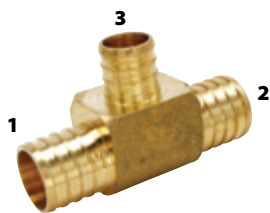

Crimp x Crimp Tees (Unequal Tees) — Run x Run x Branch (1x2x3)

Description	QTY	Model#	Order#	lbs.
1" x 1" x 3/4" Crimp LF Tee	10	LFPCT554X-10	81016943	3.0

Crimp x Crimp Brass Couplings — for making field repairs or extending RadiantPEX/RadiantPERT lines.



Description	QTY	Model#	Order#	lbs.
3/8" Crimp LF Coupling	10	LFPCC22X-10	81016944	0.2
1/2" Crimp LF Coupling	10	LFPCC33X-10	81016945	0.3
5/8" Crimp Coupling	10	PCC66X-10	81005376	1.0
3/4" Crimp LF Coupling	10	LFPCC44X-10	81016946	0.7
1" Crimp LF Coupling	10	LFPCC55X-10	81016947	2.9
1 1/4" Crimp LF Coupling	10	LFPCC77X-10	81016948	1.4
1 1/2" Crimp LF Coupling	1	LFPCC99X-10	81016949	0.3
2" Crimp LF Coupling	1	LFPCCMP110K	81016950	0.5

Use **Crimp x Crimp Brass Couplings** to make field repairs and connections when necessary. Be sure to closely follow all guidelines when making field repairs or connections.



CinchClamp Repair Kits — for making RadiantPEX/RadiantPERT repairs in the field.

Description	QTY	Model#	Order#	lbs.
1/2" LF CinchClamp Repair Kit	1	LFPCCCA3K	81016952	0.2
5/8" CinchClamp Repair Kit	1	PCCCA6K	81005326	0.3
3/4" LF CinchClamp Repair Kit	1	LFPCCCA4K	81016953	0.3

Each **CinchClamp Repair Kit** contains two double-ended barbs and four CinchClamps, enough for two splices. Each kit includes instructions to help insure that the repair is done properly.



CrimpRing Repair Kits — for making RadiantPEX/RadiantPERT repairs in the field.

Description	QTY	Model#	Order#	lbs.
3/8" CrimpRing Repair Kit	1	PCCA2K	81001063	1.0
1/2" CrimpRing Repair Kit	1	PCCA3K	81001064	1.0
5/8" CrimpRing Repair Kit	1	PCCA6K	81003429	1.0
3/4" CrimpRing Repair Kit	1	PCCA4K	81001065	1.0
1" CrimpRing Repair Kit	1	PCCA5K	81001066	1.0
1-1/4" CrimpRing Repair Kit	1	PCCA7K	81004450	1.0
1-1/2" CrimpRing Repair Kit	1	PCCA9K	81011155	1.0

Each **CrimpRing Repair Kit** contains two double-ended barbs and four CrimpRings, enough for two splices. Each kit includes instructions to help insure that the repair is done properly.

Mini Ball and Balancing Valves — for circuit isolation and balancing on field-built manifolds.



1/2" Crimp x 1/2" Male Sweat MBV

Description	QTY	Model#	Order#	lbs.
1/2" Crimp x 1/2" Female Sweat LF Mini Ball Valve	1	LFP12123PX3	81016571	0.3

NOTICE

Use **Mini Ball Valves** to isolate and/or regulate the flow of individual tubing circuits.

RadiantPEX/RadiantPERT Compression Fittings



SST20 Compression Coupling Kits — for joining lengths of RadiantPEX/RadiantPERT

Description	QTY	Model#	Order#	lbs.
SST20 Comp. Coupling Kit for 1/2" PEX	1 Kit	PXCASST3K	81005175	1.0
SST20 Comp. Coupling Kit for 5/8" PEX	1 Kit	PXCASST4K	81005176	1.0
SST20 Comp. Coupling Kit for 3/4" PEX	1 Kit	PXCASST5K	81005177	2.0

Compression Coupling Kits consist of two Compression Couplings and four female Compression fittings.

NOTICE

Not for potable water use. BSP stands for British Standard Pipe (threads). These threads are not compatible with NPT (National Pipe Threads). Most building codes do not allow compression couplings in inaccessible locations. Do not bury compression fittings.

NEW RadiantPERT ASTM F1960 Cold Expansion Fittings

For use with the Milwaukee F1960 Automatic tool. F1960 Fittings are **not** warranted for any tubing other than RadiantPERT.



F1960 Lead Free* Sweat Adapters - Male x F1960

Description	QTY	Model#	Order#	lbs.
3/8" F1960 x 1/2" LF Male Sweat Adapter	10	LFPF637X-10	81019370	1
1/2" F1960 x 1/2" LF Male Sweat Adapter	10	LFPF650X-10	81019376	1
5/8" F1960 x 3/4" LF Male Sweat Adapter	10	LFPF670X-10	81019383	2
3/4" F1960 x 3/4" LF Male Sweat Adapter	10	LFPF675X-10	81019394	2
1" F1960 x 1" LF Male Sweat Adapter	10	LFPFSM55X-10	81019767	2
3/4" F1960 x 1" LF Male Sweat Adapter	10	LFPFSM54X-10	81019768	2



F1960 Lead Free* Sweat Adapters - Female x F1960

Description	QTY	Model#	Order#	lbs.
3/8" F1960 x 1/2" LF Female Sweat Adapter	10	LFPF737X-10	81019371	1
1/2" F1960 x 1/2" LF Female Sweat Adapter	10	LFPF750X-10	81019377	1
5/8" F1960 x 3/4" LF Female Sweat Adapter	10	LFPF770X-10	81019382	2
3/4" F1960 x 3/4" LF Female Sweat Adapter	10	LFPF775X-10	81019395	2
1" F1960 x 1" LF Female Sweat Adapter	10	LFPFSF55X-10	81019769	2
3/4" F1960 x 1" LF Female Sweat Adapter	10	LFPFSF54X-10	81019770	2



F1960 Lead Free* Threaded Adapters - Male x F1960

Description	QTY	Model#	Order#	lbs.
1/2" F1960 x 1/2" LF MPT Adapter	10	LFPFMC33X-10	81019379	1
3/4" F1960 x 3/4" LF MPT Adapter	10	LFPFMC44X-10	81019397	2
3/4" F1960 x 1" LF MPT Adapter	10	LFPFM54X-10	81019757	2
1" F1960 x 1" LF MPT Adapter	10	LFPFM55X-10	81019756	2



F1960 Lead Free* Threaded Adapters - Female x F1960

Description	QTY	Model#	Order#	lbs.
1/2" F1960 x 1/2" LF FPT Adapter	10	LFPFFC33X-10	81019380	1
3/4" F1960 x 3/4" LF FPT Adapter	10	LFPFFC44X-10	81019398	2
1" F1960 x 1" LF FPT Adapter	10	LFPFF55X-10	81019758	2
1" F1960 x 3/4" LF FPT Adapter	10	LFPFF54X-10	81019759	2

NEW RadiantPERT ASTM F1960 Cold Expansion Fittings

For use with the Milwaukee F1960 Automatic tool. F1960 Fittings are **not** warranted for any tubing other than RadiantPERT.



F1960 Lead Free* Couplings - F1960 x F1960

Description	QTY	Model#	Order#	lbs.
3/8" F1960 LF Coupling	10	LFPFC22X-10	81019372	1
1/2" F1960 LF Coupling	10	LFPFC33X-10	81019378	1
5/8" F1960 LF Coupling	10	LFPFC66X-10	81019389	1
3/4" F1960 LF Coupling	10	LFPFC44X-10	81019396	2
1" F1960 LF Coupling	10	LFPFC55X-10	81019765	2
1"x 3/4" F1960 LF Coupling	10	LFPFC54X-10	81019766	2



F1960 Lead Free* Tees - F1960 x F1960

Description	QTY	Model#	Order#	lbs.
1/2" F1960 LF Tee	10	LFPFT333X-10	81019374	1
5/8" F1960 LF Tee	10	LFPFT666X-10	81019386	1
3/4" F1960 LF Tee	10	LFPFT444X-10	81019393	2
1"x3/4"x 3/4" F1960 LF Tee	10	LFPFT544X-10	81019761	2
1"x1"x 1/2" F1960 LF Tee	10	LFPFT5550X-10	81019762	2
1"x1"x 3/4" F1960 LF Tee	10	LFPFT554X-10	81019763	2
1" F1960 LF Tee	10	LFPFT555X-10	81019764	2



F1960 Lead Free* Elbows - F1960 x F1960

Description	QTY	Model#	Order#	lbs.
1/2" F1960 LF Elbow	10	LFPFE33X-10	81019375	1
5/8" F1960 LF Elbow	10	LFPFE66X-10	81019388	1
3/4" F1960 LF Elbow	10	LFPFE44X-10	81019390	2
1" F1960 LF Elbow	10	LFPFE55X-10	81019760	



F1960 Lead Free* Sweat Adapter Elbows - Male x F1960

Description	QTY	Model#	Order#	lbs.
5/8" F1960 x 3/4" LF Male Sweat Elbow	10	LFPFE64M-10	81019384	2
3/4" F1960 x 3/4" LF Male Sweat Elbow	10	LFPFE77M-10	81019392	2



F1960 Lead Free* Sweat Adapter Elbows - Female x F1960

Description	QTY	Model#	Order#	lbs.
5/8" F1960 x 3/4" LF Female Sweat Elbow	10	LFPFE64F-10	81019385	2
3/4" F1960 x 3/4" LF Female Sweat Elbow	10	LFPFE77F-10	81019391	2



PEX Rings (1 per F1960 connection)

Description	QTY	Model#	Order#	lbs.
3/8" F1960 PEX Ring	10	PFS2-10	81019400	1
1/2" F1960 PEX Ring	10	PFS3-10	81019401	1
5/8" F1960 PEX Ring	10	PFS6-10	81019402	1
3/4" F1960 PEX Ring	10	PFS4-10	81019403	1
1" F1960 PEX Ring	10	PFS5-10	81019755	1

Onix Fittings



SelfTite™ Clamps — Pretensioned for easy field installation. The chrome-vanadium spring steel maintains a constant tension on the Onix under all operating conditions. SelfTites incorporate a zinc coating to guard against corrosion.

Description	QTY	Model#	Order#	lbs.
3/8" SelfTite Clamp (19 mm)	10	663019-10	81000523	3
1/2" SelfTite Clamp (22 mm)	10	663022-10	81000526	4
5/8" SelfTite Clamp (25 mm)	10	663025-10	81000529	4
3/4" SelfTite Clamp (29 mm)	10	663029-10	81000532	5



TorqueTite™ Clamps — our best stainless steel screw clamps.

Description	QTY	Model#	Order#	lbs.
3/8" TorqueTite Clamp (17–19 mm)	10	6641117-10	81002913	2
1/2" TorqueTite Clamp (21–23 mm)	10	6641524-10	81002916	2
5/8" TorqueTite Clamp (25–27 mm)	10	6641928-10	81002919	2
3/4" TorqueTite Clamp (29–31 mm)	10	6642232-10	81002922	2

The Onix **TorqueTite** is a rugged, stainless steel clamp capable of withstanding large pressures and temperatures while being easy to install. Do not overtighten!

3/4" Female SST20

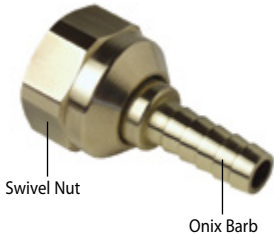

SST20 Onix Swivel Fittings — for Stainless Steel, and Custom Tubular Manifolds.

Description	QTY	Model#	Order#	lbs.
3/8" Onix x 3/4" BSP Swivel Fitting	10	689001-10	81000679	1
1/2" Onix x 3/4" BSP Swivel Fitting	10	689002-10	81000681	1
5/8" Onix x 3/4" BSP Swivel Fitting	10	689003-10	81000683	2
3/4" Onix x 3/4" BSP Swivel Fitting	10	689004-10	81000684	2

Use these female **Onix SST20** Fittings to connect Onix to our Stainless Steel manifolds. Order Onix SelfTite or TorqueTite clamps separately. BSP threads are not compatible with NPT.



Onix Barb x Male Sweat Fittings — for transitioning Onix to sweat fittings.

Description	QTY	Model#	Order#	lbs.
3/8" Onix x 1/2" Male Sweat Adapter	10	684001-10	81000659	1
1/2" Onix x 1/2" Male Sweat Adapter	10	685001-10	81000663	1
5/8" Onix x 1/2" Male Sweat Adapter	10	686001-10	81000667	1
3/4" Onix x 3/4" Male Sweat Adapter	10	687001-10	81000671	2

Sweat **Onix Barbs** into copper tees or ball valves for easy field manifold construction



Onix Sweat Elbow Fittings — for connecting Onix supply lines to baseboard, fan coils, or kick space heaters.

Description	QTY	Model#	Order#	lbs.
1/2" Onix x 3/4" Female Sweat	10	185074-10	81000116	3
5/8" Onix x 3/4" Female Sweat	10	185625-10	81000120	3
3/4" Onix x 3/4" Female Sweat	10	185075-10	81000118	3

Use these all brass **Onix Elbow Fittings** to make transitions to baseboards, radiators, or fan coils when using Onix as supply/return piping.

Onix Fittings



SelfTite™ Onix Repair Kits — pre-assembled kits for field repairs. Each repair kit includes two splices and four SelfTite clamps.

Description	QTY	Model#	Order#	lbs.
3/8" SelfTite Onix Repair Kit	1 kit	660075	81000507	1
1/2" SelfTite Onix Repair Kit	1 kit	660085	81000509	1
5/8" SelfTite Onix Repair Kit	1 kit	660105	81000511	2
3/4" SelfTite Onix Repair Kit	1 kit	660125	81000513	2



TorqueTite™ Onix Repair Kits — pre-assembled kit for field repairs. Each repair kit includes two splices and four TorqueTite clamps.

Description	QTY	Model#	Order#	lbs.
3/8" TorqueTite Repair Kit	1 kit	660076	81000508	1
1/2" TorqueTite Repair Kit	1 kit	660086	81000510	1
5/8" TorqueTite Repair Kit	1 kit	660106	81000512	2
3/4" TorqueTite Repair Kit	1 kit	660126	81000514	2

Onix Couplings — for making field repairs.



Description	QTY	Model#	Order#	lbs.
3/8" Onix Coupling	10	677062-10	81000611	1
1/2" Onix Coupling	10	677082-10	81000615	1
5/8" Onix Coupling	10	677101-10	81000618	1
3/4" Onix Coupling	10	677121-10	81000621	1

NOTICE

Use **Onix Couplings** to make field repairs and connections when necessary. Be sure to use Watts Radiant's TorqueTite or SelfTite clamps when making all field splice repairs and closely follow all guidelines. Order clamps separately.



Mini Ball and Balancing Valves — for circuit isolation and balancing on field-built manifolds.

Description	QTY	Model#	Order#	lbs.
3/8" Onix x 1/2" Male Sweat MBV (0.44" bore)	1	446105	81000366	3

NOTICE

Use **Mini Ball Valves** to isolate and/or regulate the flow of individual tubing circuits on field built manifolds.



Onix™ is fast, quiet, hassle free, and remains highly flexible in cold conditions.

RadiantPEX-AL Compression Fittings

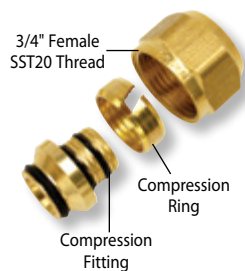

RadiantPEX-AL SST20 Compression Fitting — for stainless steel and T20 manifolds.

Description	QTY	Model#	Order#	lbs.
3/8" Compression x 3/4" SST20 BSP, Adapter	10	RLC01B06T20-10	81011138	1
1/2" Compression x 3/4" SST20 BSP, Adapter	10	RLC0501B08T20-10	81010735	1
5/8" Compression x 3/4" SST20 BSP, Adapter	10	RLC01B10T20-10	81008088	2
3/4" Compression x 3/4" SST20 BSP, Adapter	10	RLC01B12T20-10	81007735	2

Compression nut and ring included with all compression fittings.

NOTICE

BSP threads are not compatible with NPT.

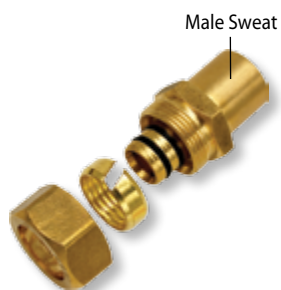

RadiantPEX-AL Adapter — Compression x Male Sweat

Description	QTY	Model#	Order#	lbs.
3/8" Compression x 1/2" Male Sweat, Adapter	10	RLC10B0608-10	81011139	1
1/2" Compression x 1/2" Male Sweat, Adapter	10	RLC0510B0808-10	81010731	1
5/8" Compression x 1/2" Male Sweat, Adapter	10	RLC10B1008-10	81008092	1
5/8" Compression x 3/4" Male Sweat, Adapter	10	RLC10B1012-10	81008094	2
3/4" Compression x 3/4" Male Sweat, Adapter	10	RLC10B1212-10	81008096	2
1" Compression x 1" Male Sweat, Adapter	5	RLC10B1616-5	81008098	3

O-rings and Insulators are shipped loose on all sweat fittings.

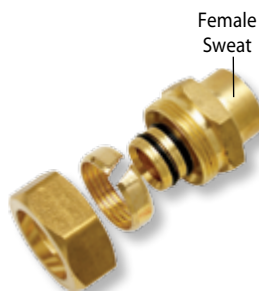

RadiantPEX-AL Adapter — Compression x Female Sweat

Description	QTY	Model#	Order#	lbs.
3/8" Compression x 1/2" Female Sweat, Adapter	10	RLC11B0608-10	81011140	1
1/2" Compression x 1/2" Female Sweat, Adapter	10	RLC0511B0808-10	81010732	1
5/8" Compression x 3/4" Female Sweat, Adapter	10	RLC11B1012-10	81008102	2
3/4" Compression x 3/4" Female Sweat, Adapter	10	RLC11B1212-10	81008104	2
1" Compression x 1" Female Sweat, Adapter	5	RLC11B1616-5	81013675	2

O-rings and Insulators are shipped loose on all sweat fittings.



RadiantPEX-AL Adapter — Compression x Male NPT

Description	QTY	Model#	Order#	lbs.
1/2" Compression x 3/4" MPT, Adapter	10	RLC0512B0812-10	81010729	2
5/8" Compression x 3/4" MPT, Adapter	10	RLC12B1012-10	81008108	2
3/4" Compression x 3/4" MPT, Adapter	10	RLC12B1212-10	81008110	3
1" Compression x 1" MPT, Adapter	5	RLC12B1616-5	81008112	3

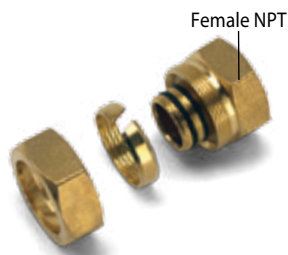

RadiantPEX-AL Adapter — Compression x Female NPT

Description	QTY	Model#	Order#	lbs.
1" Compression x 1" FPT, Adapter	5	RLC13B1616-5	81013676	2

RadiantPEX-AL Compression Fittings



RadiantPEX-AL Compression Couplings

Description	QTY	Model#	Order#	lbs.
3/8" Compression Coupling	10	RLC15B0606-10	81011141	1
1/2" Compression Coupling	10	RLC0515B0808-10	81010716	1
5/8" Compression Coupling	10	RLC15B1010-10	81008116	1
3/4" Compression Coupling	10	RLC15B1212-10	81008118	2
1" Compression Coupling	5	RLC15B1616-5	81008120	2



RadiantPEX-AL Compression Elbow (Equal)

Description	QTY	Model#	Order#	lbs.
5/8" Compression Elbow	10	RLC19B1010-10	81008122	1
3/4" Compression Elbow	10	RLC19B1212-10	81008124	2
1" Compression Elbow	5	RLC19B1616-5	81008127	2



RadiantPEX-AL Compression Tee (Equal)

Description	QTY	Model#	Order#	lbs.
3/4" Compression Tee	10	RLC18B121212-10	81008129	3
1" Compression Tee	5	RLC18B161616-5	81008131	3



RadiantPEX-AL Extra Insulators for Compression Fittings

Description	QTY	Model#	Order#	lbs.
3/8" Extra Compression Fitting Insulator	10	RLC43IN06-10	81011165	.5
1/2" Extra Compression Fitting Insulator	10	RLC0543IN08-10	81010697	.5
5/8" Extra Compression Fitting Insulator	10	RLC43IN10-10	81009456	.5
3/4" Extra Compression Fitting Insulator	10	RLC43IN12-10	81009458	.5
1" Extra Compression Fitting Insulator	10	RLC43IN16-10	81009460	.5

Extra insulators are only needed if they are damaged or lost in the field.



RadiantPEX-AL Extra O-Rings for Compression Fittings

Description	QTY	Model#	Order#	lbs.
3/8" Extra Compression Fitting O-Rings	10	RLC44OR06-10	81011167	.5
1/2" Extra Compression Fitting O-Rings	10	RLC0544OR08-10	81010652	.5
5/8" Extra Compression Fitting O-Rings	10	RLC44OR10-10	81008567	.5
3/4" Extra Compression Fitting O-Rings	10	RLC44OR12-10	81008568	.5
1" Extra Compression Fitting O-Rings	10	RLC44OR16-10	81008569	.5

Extra O-rings are only needed if they are damaged or lost in the field.

Watts Radiant offers a wide variety of stainless steel and copper manifolds. Any of these styles can be fitted with Onix, PEX Crimp, PEX Compression, or RadiantPEX-AL Compression fittings. RadiantPERT ASTM F1960 Fittings are available for Stainless Steel manifolds.

Stainless Steel Manifolds



Stainless Steel manifolds are made of heavy-walled stainless steel. Matching fittings and accessories are made of solid brass and are heavily plated with nickel to match the appearance of the manifold trunk. Standard features included flow balancing valves, circuit isolation valves, and flow meters. Manifolds are sold in pre-mounted pairs in 1" and hi flow sizes.

Custom Tubular Manifold Pairs

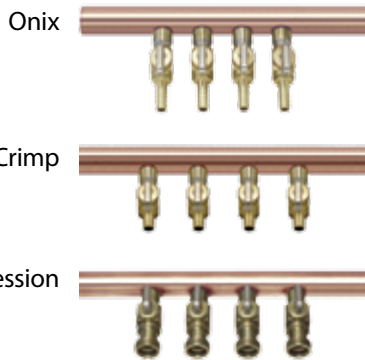

Watts Radiant **Custom Tubular manifolds** are manufactured to project specifications. All trunks are made of copper; all fittings and ball valves are brass. Every manifold is pressure tested before leaving the factory. Custom Tubular are sold in pairs. Manifolds are available in 1"-6" ID trunk sizes.

Four configurations are possible:

- Standard** — no mini ball valves
- BVR** — mini ball valves on the return manifold
- BVSR** — mini ball valves on supply and return manifolds
- BBSR** — balance ball valves on return, mini-ball valves on supply manifold

CustomCut™ Manifolds

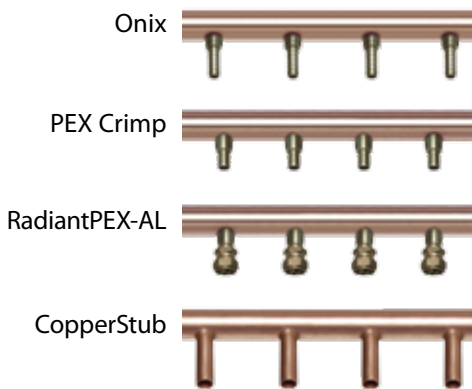

CustomCut manifolds are designed for flexibility for the installer. They come in 4 foot long copper sticks to be cut in the field. Sticks can be ordered with either 12 (4" spacing) or 16 (3" spacing) branches.

- Sold Individually.

Three fitting styles are available for CustomCuts :

- Onix
- PEX Crimp
- RadiantPEX-AL Compression

Swedged Manifolds



Swedged manifolds are 1" copper manifolds closed at one end and swedged at the other. Cut off the end of a 3-branch and solder it to another 3-branch to make a 6-branch manifold.

- Sold Individually.
- Swedged manifolds available in PEX-AL Compression only.

1" and Hi Flow Stainless Steel Manifolds

- Fast and Easy to Install
- Instant and Easy Circuit Balancing
- Vent/purge assembly allows even easier purging
- Professional Appearance

- Gaskets allow air or water pressure test.
- Flowmeter valves allow circuit isolation

Specifications	1"	Hi Flow
Trunk Material	ANSI 304 Stainless Steel	
Nominal Trunk Size	1"	1-1/2"
Circuit Spacing	2"	
Thread/Connection Type	BSP (British Standard Pipe)	
Max. Trunk Flow Rate	12 gpm	22 gpm
Max. Circuit Flow Rate	2 gpm	4 gpm
Max. Operating Temperature	176°F	
Max. Operating Pressure	87 psi	

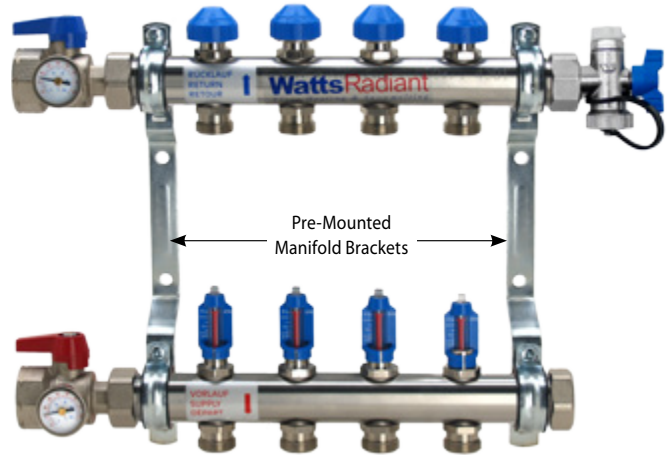

Matching fittings and accessories are made of solid brass and heavily plated with nickel to match the appearance of the manifold trunk. Standard features include flow balancing valves and flow meters on each circuit. Manifolds are sold in pre-mounted pairs.

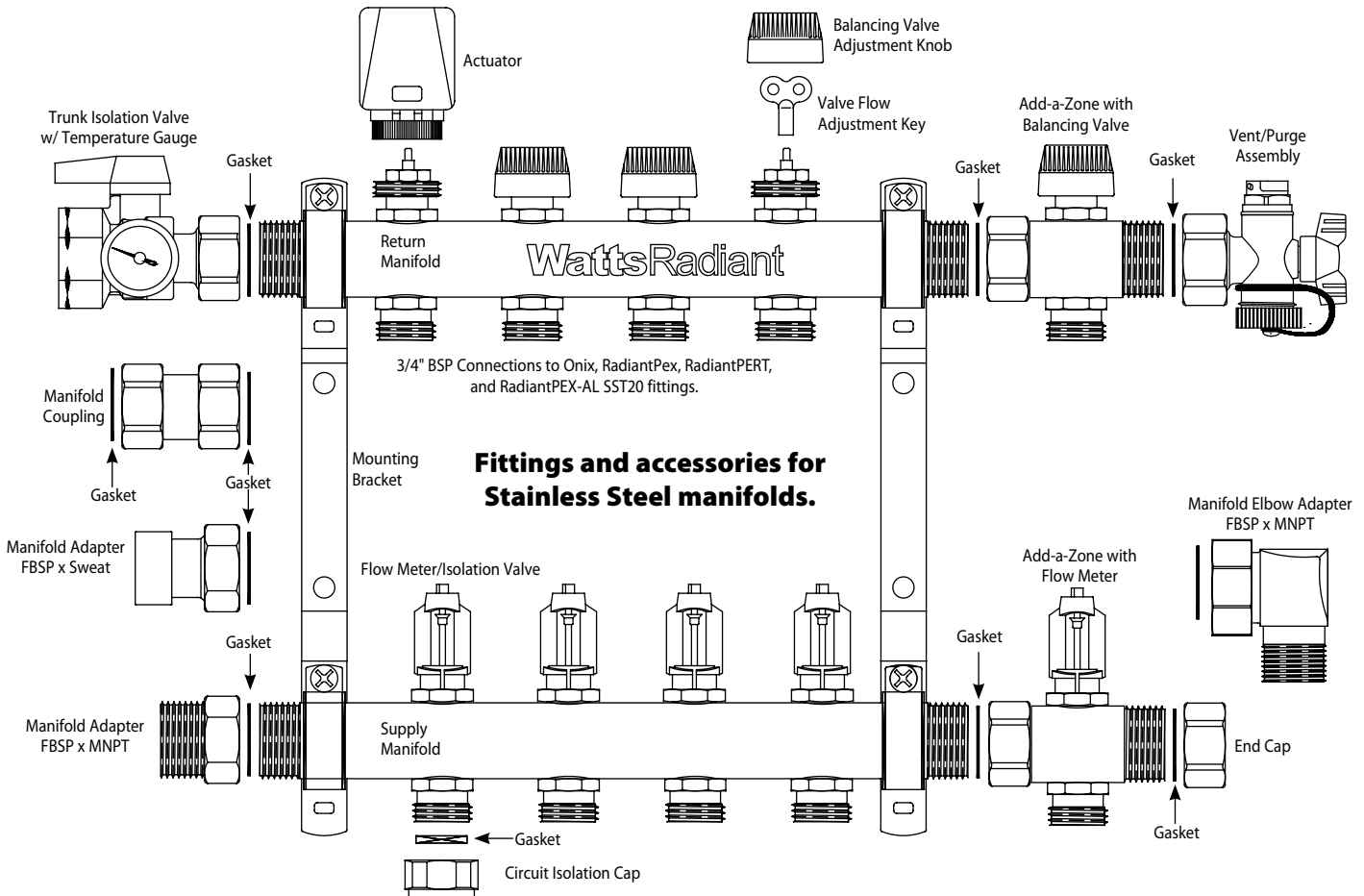

Only SST20 style parts are compatible with Stainless Steel manifolds.

1" Stainless Steel Manifolds with Trunk Isolation Kit



1" Stainless Steel Manifold Kits	QTY	Model#	Order#	lbs.
1" Flowmeter Manifold, S.S., M-2 with Trunk iso. kit	1 Kit	D3803002SS-KIT	81013279	11
1" Flowmeter Manifold, S.S., M-3 with Trunk iso. kit	1 Kit	D3803003SS-KIT	81013280	12
1" Flowmeter Manifold, S.S., M-4 with Trunk iso. kit	1 Kit	D3803004SS-KIT	81013281	13
1" Flowmeter Manifold, S.S., M-5 with Trunk iso. kit	1 Kit	D3803005SS-KIT	81013282	14
1" Flowmeter Manifold, S.S., M-6 with Trunk iso. kit	1 Kit	D3803006SS-KIT	81013283	16
1" Flowmeter Manifold, S.S., M-7 with Trunk iso. kit	1 Kit	D3803007SS-KIT	81013284	16
1" Flowmeter Manifold, S.S., M-8 with Trunk iso. kit	1 Kit	D3803008SS-KIT	81013285	17
1" Flowmeter Manifold, S.S., M-9 with Trunk iso. kit	1 Kit	D3803009SS-KIT	81013286	18
1" Flowmeter Manifold, S.S., M-10 with Trunk iso. kit	1 Kit	D3803010SS-KIT	81013287	19
1" Flowmeter Manifold, S.S., M-11 with Trunk iso. kit	1 Kit	D3803011SS-KIT	81013288	20
1" Flowmeter Manifold, S.S., M-12 with Trunk iso. kit	1 Kit	D3803012SS-KIT	81013289	22

Stainless Steel Manifolds are sold in pairs, mounted to metal bracket as shown. Accessories such as Trunk Isolation Ball Valves, Vent/Purge Assemblies, and Actuators are purchased separately. For added convenience, several of these accessories can be purchased in kits (see next page).

1" and Hi Flow Stainless Steel Manifolds



1" Stainless Steel Manifolds	QTY	Model#	Order#	lbs.
1" Flowmeter Manifold, Stainless Steel, M-2	1 Pair	D3803002SS	81001981	9
1" Flowmeter Manifold, Stainless Steel, M-3	1 Pair	D3803003SS	81001982	10
1" Flowmeter Manifold, Stainless Steel, M-4	1 Pair	D3803004SS	81001983	11
1" Flowmeter Manifold, Stainless Steel, M-5	1 Pair	D3803005SS	81003398	12
1" Flowmeter Manifold, Stainless Steel, M-6	1 Pair	D3803006SS	81001984	13
1" Flowmeter Manifold, Stainless Steel, M-7	1 Pair	D3803007SS	81003682	13
1" Flowmeter Manifold, Stainless Steel, M-8	1 Pair	D3803008SS	81001985	14
1" Flowmeter Manifold, Stainless Steel, M-9	1 Pair	D3803009SS	81003687	15
1" Flowmeter Manifold, Stainless Steel, M-10	1 Pair	D3803010SS	81001986	16
1" Flowmeter Manifold, Stainless Steel, M-11	1 Pair	D3803011SS	81003688	17
1" Flowmeter Manifold, Stainless Steel, M-12	1 Pair	D3803012SS	81001987	19

Hi Flow Stainless Steel Manifolds	QTY	Model#	Order#	lbs.
Hi Flow Manifold, Stainless Steel, M-2	1 Pair	D3813202SS	81009661	13
Hi Flow Manifold, Stainless Steel, M-3	1 Pair	D3813203SS	81009662	14
Hi Flow Manifold, Stainless Steel, M-4	1 Pair	D3813204SS	81005355	15
Hi Flow Manifold, Stainless Steel, M-5	1 Pair	D3813205SS	81005356	16
Hi Flow Manifold, Stainless Steel, M-6	1 Pair	D3813206SS	81005357	17
Hi Flow Manifold, Stainless Steel, M-7	1 Pair	D3813207SS	81009663	18
Hi Flow Manifold, Stainless Steel, M-8	1 Pair	D3813208SS	81005358	19
Hi Flow Manifold, Stainless Steel, M-9	1 Pair	D3813209SS	81009664	20
Hi Flow Manifold, Stainless Steel, M-10	1 Pair	D3813210SS	81005359	21
Hi Flow Manifold, Stainless Steel, M-11	1 Pair	D3813211SS	81009665	22
Hi Flow Manifold, Stainless Steel, M-12	1 Pair	D3813212SS	81005360	23

Only SST20 style parts are compatible with Stainless Steel manifolds.

Stainless Steel Manifold Accessories



Add-a-Zone with Balancing Valve and Gasket



Add-a-Zone with Flow Meter and Gasket

Stainless Steel Add-a-Zone — add a branch to your manifold

Description	QTY	Model#	Order#	lbs.
Stainless Steel Add-A-Zone set, 1"	1	D3804000SS	81002934	3

Add-a-Zone sets make it easy to add additional capacity to a manifold already installed. Just thread them onto the end of a manifold. Set includes balance valve and flow meter sides of manifold.

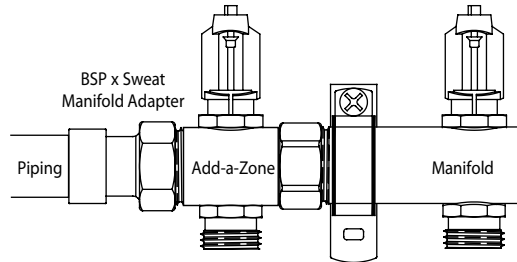

An Add-a-Zone attached to the end of a Stainless Steel supply manifold to increase capability.

Simplify manifold ordering and save money with these Manifold Accessory Kits!

Manifold kits come complete with one Vent-and-Purge Assembly, one Manifold End Cap, and a pair of Trunk Isolation Valves, BSP x NPT Manifold Adapters, or BSP x Sweat Manifold Adapters. All Manifold Accessory Kits include both neoprene and fiber gaskets.

Iso BV Kit

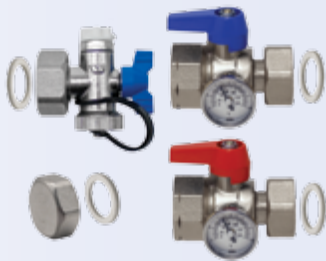

SS Manifold Accessories Kit with Trunk Isolation Ball Valves

Deluxe BV Kit

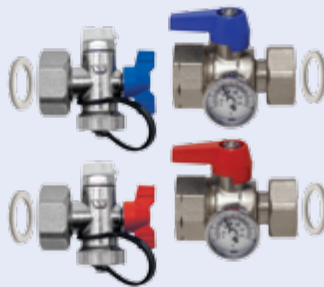

Sweat Kit

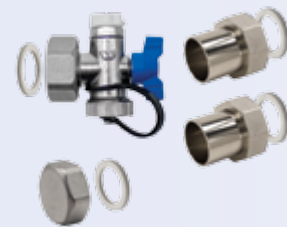

SS Manifold Accessories Kit with BSP x Sweat Manifold Adapters

Description	QTY	Model#	Order#	lbs.
1" SS Accessories Kit w/ 1" FNPT Isolation Ball Valves	1 Kit	DK1000	81003736	3
1" SS Accessories Kit w/ 3/4" Sweat Manifold Adapters	1 Kit	DK7000	81005455	3
1" SS Accessories Kit w/ 1" Sweat Manifold Adapters	1 Kit	DK3000	81005369	3
1" SS Deluxe Accessories Kit w/ 1" FNPT Isolation Ball Valves and 2 Vent/Purge Fittings	1 Kit	DK1010	81006651	4

Hi Flow SS Accessories Kit w/ 1-1/2" FNPT Isolation Ball Valves	1 Kit	DK4000	81005370	3
Hi Flow Accessories Kit w/ 1-1/2" Sweat Manifold Adapters	1 Kit	DK6000	81005372	3

Only SST20 style parts are compatible with Stainless Steel manifolds.

Stainless Steel Manifold Accessories



Transitional Trunk Isolation Ball Valves with Temperature Gauge — provides manifold isolation and transition to NPT threads.

Description	QTY	Model#	Order#	lbs.
1" SS Trunk Isolation Valve Set	1	D4201720-P	81003400	4
1-1/4" Hi Flow SS Trunk Isolation Valve Set	1	D3114015-P	81015002	4
1-1/2" Hi Flow SS Trunk Isolation Valve Set	1	D3515900-P	81009666	6

These nickel-plated brass manifold ball valves include temperature gauges to measure supply and return temperatures for troubleshooting or system balancing. They also provide transition from MBSP manifold threads to FNPT threads.

Valve sets include 1 red handle and 1 blue handle nickel plated brass ball valve FBSP x FNPT, 2 temperature gauges and 2 Gaskets. **Individual valves available for repair parts.**

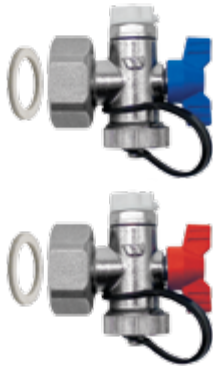

Vent-and-Purge Assemblies — for purging air and water from the zones.

Description	QTY	Model#	Order#	lbs.
1" Vent-and-Purge Assembly	1	D3036120-N	81006639	1
Hi Flow Vent-and-Purge Assembly	1	D3515940-N	81005457	1

This assembly allows for the purging of zones at the manifold location. It includes 3/8" manual air vent and a 1/2" ball valve with GHT for the supply and return. Nickel plated brass.



Manifold End Caps — to cap flow at end of manifold trunk.

Description	QTY	Model#	Order#	lbs.
SS Manifold End Cap, 1"	1	D063064-N	81001977	0.5
SS Manifold End Cap, Hi Flow	1	D3515910-N	81005425	0.5

These **Manifold End Caps** are used to cap off the end of a Stainless Steel Manifold when a vent-and-purge assembly is not used. Nickel-plated brass.



Stainless Steel Manifold Couplings — for connecting one manifold to another.

Description	QTY	Model#	Order#	lbs.
Pair 1" SS Manifold Coupling, Nickel Plated	1	D425400-P	81001988	1
Pair Hi Flow SS Manifold Coupling, Nickel Plated	1	D3230010-P	81005426	1

These **Manifold Couplings** are used to connect two manifold pairs. For example, an M-4 can be connected to an M-3 using the coupler to make an M-7. Nickel-plated brass for corrosion resistance. Sold as pairs.

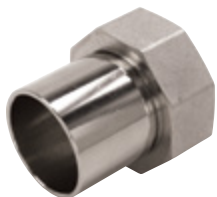

Transitional Swivel BSP x Female Sweat Manifold Adapters — for connecting Stainless Steel Manifolds to copper pipe.

Description	QTY	Model#	Order#	lbs.
1" SS Manifold x 3/4" Female Sweat, Adapter	1	D0504	81005366	1
1" SS Manifold x 1" Female Sweat, Adapter	1	D0505	81005367	1
Hi Flow SS Manifold x 1-1/2" Female Sweat, Adapter	1	D0708	81005480	1

BSP x Sweat Manifold Adapters connect Stainless Steel Manifolds to or copper pipe. Nickel-plated brass for corrosion resistance. These are not needed if you are using the Transitional Trunk Valves. Sold individually.

Only SST20 style parts are compatible with Stainless Steel manifolds.

Stainless Steel Manifold Accessories



Transitional BSP x NPT Manifold Adapters — for connecting Stainless Steel manifolds to NPT fittings.

Description	QTY	Model#	Order#	lbs.
1" Pair FBSP to 1" MNPT Adapter	1	D4201480-P	81001989	1
Hi Flow Pair FBSP to 1-1/2" MNPT Adapter	1	D3515920-N	81005368	1

Use BSP x NPT Manifold Adapters to connect Stainless Steel Manifolds to standard pipe. This fitting features female BSP threads on the manifold side and male NPT threads on the pipe side. Nickel-plated brass for corrosion resistance. These are not needed if you are using the Transitional Trunk Isolation Valves.

Female Swivel BSP
(Connects to manifold)

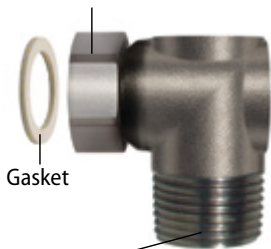

Gasket

Male BSP
(Connects to transitional adapters)

Transitional BSP x BSP Manifold Elbows — easily install supply lines at 90° to manifold.

Description	QTY	Model#	Order#	lbs.
1" SS Manifold Elbow, Female BSP x Male BSP	1	D3517020-N	81005364	1
Hi Flow SS Manifold Elbow, Female BSP x Male BSP	1	D3515925-N	81005365	1

Use Manifold Elbows to connect directly to the manifold, then connect an ISO Ball Valve or other transitional fitting to the male BSP side of the Elbow. Adapter or a Trunk Isolation Ball Valve is used to transition to NPT threads.



Circuit Isolation Cap — for unused circuits in Stainless Steel manifolds.

Description	QTY	Model#	Order#	lbs.
SS Circuit Isolation Cap	1	D4201700-S	81005479	1

Circuit Isolation Caps are used to "seal off" unused circuits on the manifolds. They can be used in conjunction with the built-in circuit isolation valves to convert an M-8 manifold into an M-7 manifold. Nickel-plated brass for corrosion resistance. Sold individually.



Indicator window on front of actuator valve. Window shows red when valve is closed, black when valve is open.

Valve Actuator — for low wattage, individual radiant circuit control.

Description	QTY	Model#	Order#	lbs.
Valve Actuator, 2 wire with end switch	1	22C24NC2	81006634	1
Valve Actuator, 4 wire with end switch	1	22C24NC4	81001541	1

Great for multiple small radiant zones. The Valve Actuator provides on/off flow control to individual radiant circuits. Incorporates an indicator window that allows you to visually determine whether the valve is fully open or closed. Flow can be balanced prior to installing by turning the adjustment valve under the blue cap. Actuator is 24 VAC (2.5 W).

Stainless Steel Manifold Accessories



Stainless Steel Manifold Replacement Parts

Description	QTY	Model#	Order#	lbs.
1" SS Manifold fiber replacement gasket	10	390095-10	81011084	1
Hi Flow SS Manifold fiber replacement gasket	10	390090-10	81011085	1
1" SS Manifold neoprene replacement gasket	10	390096-10	81011086	1
Hi Flow SS Manifold neoprene replacement gasket	10	390097-10	81011087	1
SS Manifold replacement blue cap	1	428337	81007329	1
1" SS Manifold replacement flowmeter/valve (0-2 gpm)	1	D3151122N	81011159	2
Hi Flow SS Manifold replacement flowmeter/valve (0-4 gpm)	1	D3151190N	81011160	2
SS Manifold replacement temperature gauge	1	D6151005	81003402	1

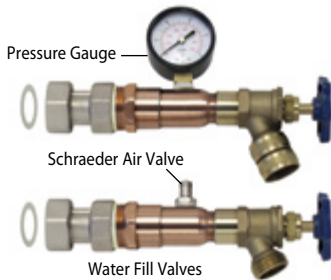

Stainless Steel Manifold Pressure Test Kits — specially fitted for Stainless Steel Manifolds.

Description	QTY	Model#	Order#	lbs.
1" Manifold Pressure Test Kit	1 Kit	D665161	81001996	4
Hi Flow Manifold Pressure Test Kit	1 Kit	D665261	81005373	4

Manifold Boxes — for wall or ceiling-mounted manifold systems.



Description	QTY	Model#	Order#	lbs.
Manifold Box, 16" x 29" x 4-1/2"	1	PZ162904	81001525	7
Manifold Box, 24" x 29" x 4-1/2"	1	PZ242904	81003497	15
Manifold Box, 40" x 29" x 4-1/2"	1	PZ402904	81004517	22

Manifold Boxes protect manifolds with a locking door. **Only doors and frame are powder coated.** All types of 1" – 1-1/2" Watts Radiant manifolds can be mounted in these boxes. Dimensions are width x height x depth. Depth can be expanded to 6", and box height off floor is adjustable.



- 16" box fits a SS M-3 with vent/purge and iso valve
- 24" box fits a SS M-7 with vent/purge and iso valve
- 40" box fits a SS M-12 with vent/purge and iso valve

See *ThermalPro zone* section for installed manifolds with pre-wired actuators.

Custom Copper Tubular Manifold Pairs

Custom Copper Tubular manifolds allow you to specify exactly what you want in a factory tested and warranted product. All Custom Tubular manifolds are supply and return pairs. Use the model number diagram below to order custom manifolds.

Several accessories can be installed on your Custom Tubular Manifolds, including (see page 30 for details):

- Brass O-ring Unions
- Full-port Brass Trunk Isolation Ball Valves
- Vent-and-Purge Assemblies

These must be treated as separate line items when ordering.

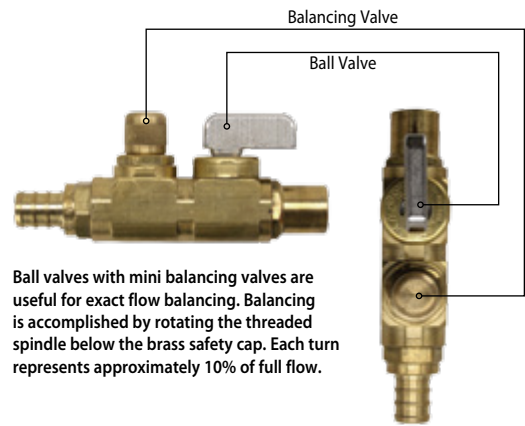

Ball valves with mini balancing valves are useful for exact flow balancing. Balancing is accomplished by rotating the threaded spindle below the brass safety cap. Each turn represents approximately 10% of full flow.

How to order Custom Tubular manifolds

XX 15 X X XX XXXX

Balancing Options:

- Blank = no balancing
- BVR = Mini-ball valves on return manifold
- BVSR = Mini-ball valves on supply and return manifold
- BBSR = Mini-ball valves on supply manifold, balance ball valves on return

Number of Circuits:

- 01 = 1 circuit
- 02 = 2 circuits
- 03 = 3 circuits
- etc... Generally Watts Radiant recommends a maximum of 15 circuits per manifold for balancing reasons.

Barb Size:

- 2 = 3/8"
- 3 = 1/2"
- 4 = 5/8"
- 5 = 3/4"

Manifold Trunk Size:

- 4 = 1" Copper Trunk
- 5 = 1 1/4" Copper Trunk
- 6 = 1 1/2" Copper Trunk
- * call for larger trunk sizes

15 = Designator for Custom Manifolds

Manifold Type:

- Blank = Onix
- PC = PEX/PERT Crimp
- RLC = RadiantPEX-AL Compression (complete with compression nut and ring)

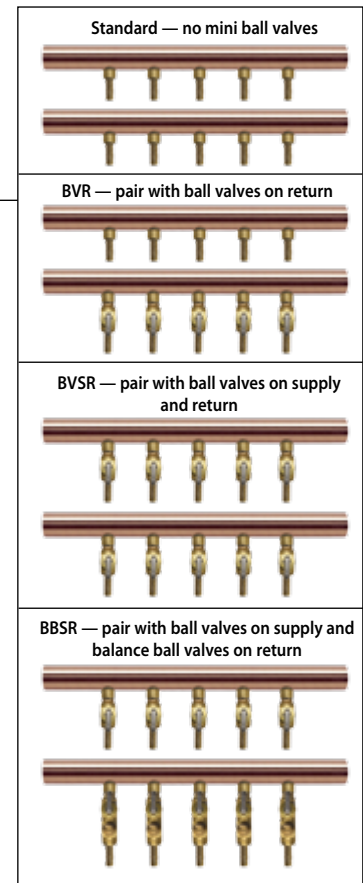

- Ordering examples:**
- PC156410BVR = 10 branch, 1-1/2" trunk, 5/8" PEX Crimp manifold with mini ball valves on return
 - 154207BBSR = 7 branch, 1" trunk, 3/8" Onix manifold with mini ball valves on supply and balance valves on return

CustomCut™ Manifolds **COST EFFECTIVE**

CustomCut Manifolds are designed for flexibility at the wholesale and the installation level. They come in 4-ft.-long copper "sticks" to be cut to length in the field — cut off five branches for a 5-branch manifold, seven branches for a 7-branch manifold, and so on. You can stock just a few types and have everything you need.

CustomCuts are made in various styles with:

- Brass fittings: Onix, PEX, and RadiantPEX-AL Compression.
- 1/2" and 3/4" Copper Stubs, for attaching standard ball valves or female copper sweat fittings in the field.
- 1/2" Brass Base Branches, for attaching Watts Radiant 1/2" male sweat fittings or Mini Ball Valves in the field.

CustomCuts are made with branches spaced at 3" (16 circuits) or 4" (12 circuits) on center, depending on the type of manifold. They are available with and without Mini Ball Valves (MBVs).

CustomCuts are sold as a single manifold, not in pairs.

Onix CustomCut Manifolds — 4 ft. long

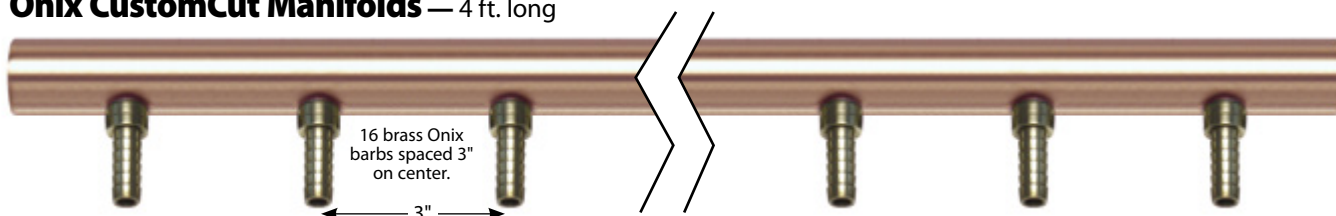

16-branch CustomCut Manifolds, 3/8" Onix Barbs

Description	QTY	Model#	Order#	lbs.
3/8" Onix CustomCut, 16-branch, 1" Trunk (no MBVs)	1	204237	81001937	7
3/8" Onix CustomCut w/MBVs, 16-branch, 1" Trunk	1	204237BV	81001940	14

PEX CustomCut Manifolds — 4 ft. long

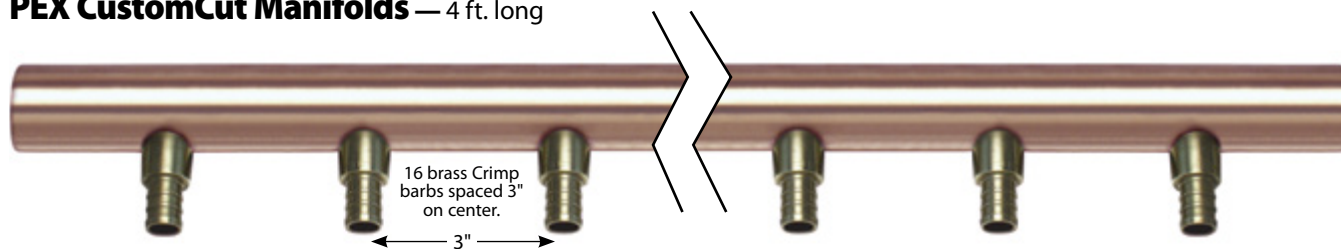

16-branch CustomCut Manifolds, 1/2" PEX Crimp Barbs

Description	QTY	Model#	Order#	lbs.
1/2" Crimp CustomCut, 16-branch, 1" Trunk	1	LFPC204250	81016963	7
1/2" Crimp CustomCut w/MBVs, 16-branch, 1" Trunk	1	LFPC204250BV	81016964	14

CustomCut Manifolds

RadiantPEX-AL CustomCut Manifolds — Compression Fittings, 4 ft. long

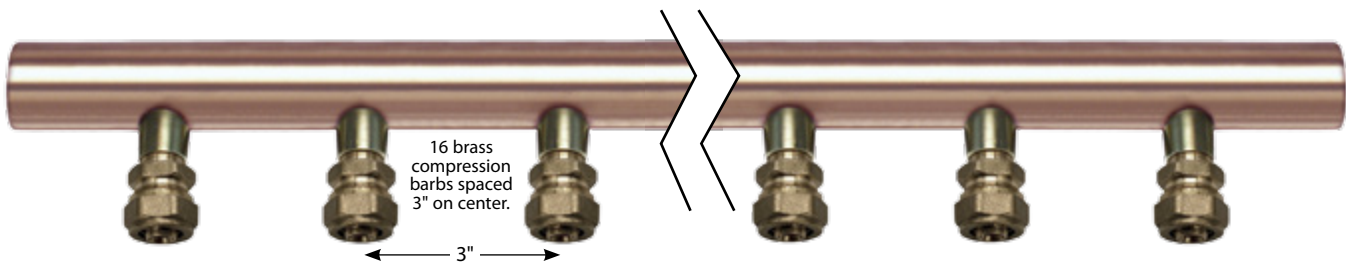

1/2" RadiantPEX-AL CustomCut Manifolds – Compression Fittings

Description	QTY	Model#	Order#	lbs.
1/2" Compression, 16- branch, 1" Trunk (no MBVs)	1	RLCM05-M16-08X16	81010694	7
1/2" Compression w/MBVs, 16- branch, 1" Trunk	1	RLCM05-M16BV-08X16	81010692	14

All compression manifolds are sold complete with compression fittings including nut and compression ring.

CopperStub CustomCut Manifolds

All stubs are brazed to the manifold trunk. CopperStub Manifolds are four feet long, with stubs spaced at 3" on center (16-branch) or 4" on center (12-branch). Ball valves, zone valves, female sweat fittings, or any other hydronic accessory can be installed directly onto the 1/2" or 3/4" stub.

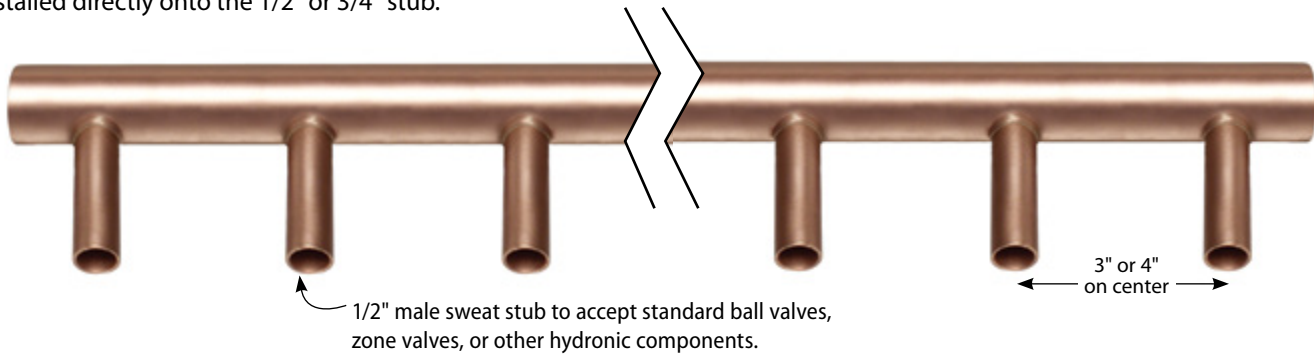

1/2" CopperStub CustomCuts (Male Sweat)

Description	QTY	Model#	Order#	lbs.
1/2" Stub, 16-branch x 1" Trunk x 48" long	1	205116	81001944	7

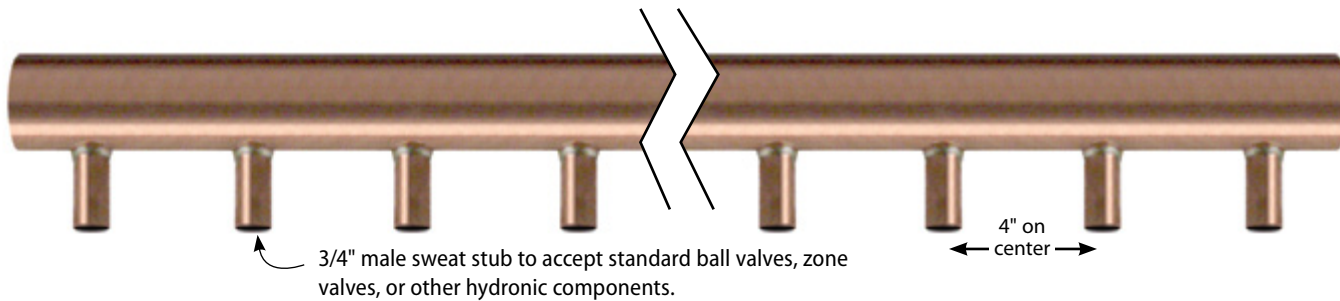

3/4" CopperStub CustomCuts with 3/4" Stubs (Male Sweat)

Description	QTY	Model#	Order#	lbs.
3/4" Stub, 12-branch x 1-1/4" Trunk x 48" long	1	205412	81001951	7

Tubular Manifold Accessories — Factory-installed

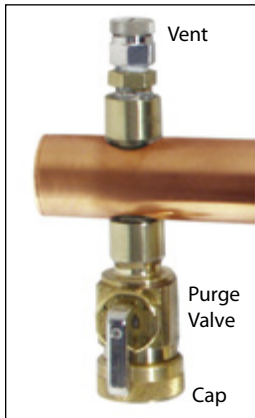

Vent-and-Purge Assemblies — factory-installed on Custom Tubular Manifolds.

Description	QTY	Model#	Order#	lbs.
1" Vent-and-Purge Assembly	1	160002	81000100	1
1-1/4" Vent-and-Purge Assembly	1	160003	81000101	1
1-1/2" Vent-and-Purge Assembly	1	160004	81000102	1
2" Vent-and-Purge Assembly	1	160005	81000103	1

Vent-and-Purge Assemblies allow water and air to be purged from the system at the manifold. The air vent is a "key-type" manual vent and the drain is threaded for a hose connection and comes complete with a shut-off ball valve and a cap. Available only for Custom Tubular Manifolds. Sold Individually.

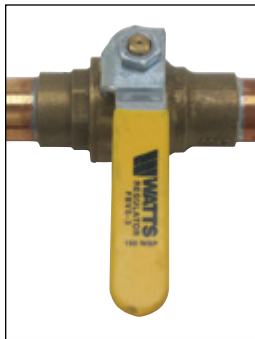

Full-port Trunk Isolation Ball Valves — factory-installed on Custom Tubular Manifolds.

Description	QTY	Model#	Order#	lbs.
Trunk Isolation Ball Valve, 1"	1 pair	440101-03	81000344	1
Trunk Isolation Ball Valve, 1-1/4"	1 pair	440102-03	81003371	1
Trunk Isolation Ball Valve, 1-1/2"	1 pair	440103-03	81004854	2
Trunk Isolation Ball Valve, 2"	1 pair	440104-03	81003372	2

Trunk Isolation Ball Valves are installed to shut off the flow of water to the manifold. Sold in pairs.

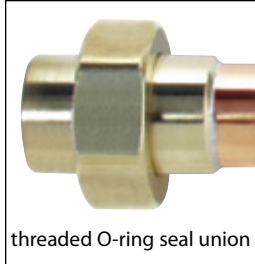

Unions (for Custom Tubular Manifolds) — factory-installed on Custom Tubular Manifolds.

Description	QTY	Model#	Order#	lbs.
1" Installed Union	1 pair	464200	81000452	2
1-1/4" Installed Union	1 pair	464202	81000454	2
1-1/2" Installed Union	1 pair	464203	81000455	3
2" Installed Union	1 pair	464204	81000456	4

Unions allow manifolds to be easily pressure tested with our Pressure Test Kits. These all-brass unions feature heavy construction with EPDM o-rings to ensure leak-proof connections, even when hand-tightened. Sold in pairs.

Tubular Manifold Accessories — Field-installed



End Assemblies — for CustomCut and Swedged Manifolds.

Description	QTY	Model#	Order#	lbs.
1" End Assembly	1	000102	81003193	1
1-1/4" End Assembly	1	000103	81003194	1
1-1/2" End Assembly	1	000104	81003195	1
2" End Assembly	1	000105	81003196	1

End Assemblies are intended for use with CustomCuts and Swedged Manifolds. They allow you to purge water and air from the system at the manifold location. The air vent is a "key-type" manual vent and the drain is threaded for a hose connection and comes complete with a shut-off ball valve and a cap. Sold Individually.

Tubular Manifold Accessories

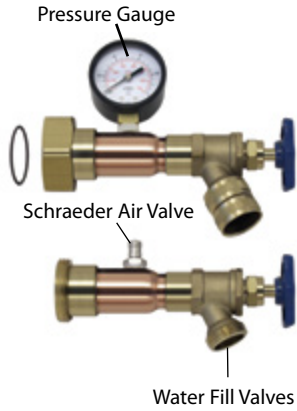

Copper Tubular Manifold Pressure Test Kits — pre-assembled to save time on the job site.

Description	QTY	Model#	Order#	lbs.
Manifold Pressure Test Kit 1"	1 kit	665161	81000550	3
Manifold Pressure Test Kit 1-1/4"	1 kit	665201	81000552	4
Manifold Pressure Test Kit 1-1/2"	1 kit	665241	81000553	5
Manifold Pressure Test Kit 2"	1 kit	665321	81000554	5

This two-part **Manifold Pressure Test Kit** enables you to test circuits and manifold connections with either air or water. They come standard with 1" brass unions to connect to Watts Radiant copper tubular manifolds or field-assembled manifolds. If you have manifolds without unions, please order loose Watts Radiant Unions to field connect with our Pressure Test Kits. Available for rental; call for prices.



Manifold Boxes — for wall or ceiling-mounted manifold systems.

Description	QTY	Model#	Order#	lbs.
Manifold Box, 16" x 29" x 4-1/2"	1	PZ162904	81001525	7
Manifold Box, 24" x 29" x 4-1/2"	1	PZ242904	81003497	15
Manifold Box, 40" x 29" x 4-1/2"	1	PZ402904	81004517	22

Manifold Boxes protect manifolds with a locking door. **Only doors and frames are powder coated.** All types of 1" – 1-1/2" Watts Radiant manifolds can be mounted in these boxes. Dimensions are width x height x depth. Depth can be expanded to 6", and box height off floor is adjustable.



- 16" box fits a custom tubular M-5 (Onix)/M-4 (PEX or PAP) with vent/purge
- 24" box fits a custom tubular M-11 (Onix)/M-8 (PEX or PAP) with vent/purge
- 40" box fits a custom tubular M-20 (Onix)/M-16 (PEX or PAP) with vent/purge

See ThermalPro zone section for installed manifolds with pre-wired actuators.



Universal Manifold Mounting Brackets — for holding 1" to 1-1/4" Tubular Manifolds to wood frames.

Description	QTY	Model#	Order#	lbs.
Mtg. Brackets for 1"–1-1/4" Tubular Manifolds	1 Pr.	666162	81000558	1

Manifold Mounting Brackets are made of a flexible, high-temperature polymer that allows you to secure the manifold to a stud, joist, or other wood framing member.



Insulated supply and return piping for:

- Hydronic heating
- Hydronic snow melting
- District heating
- Commercial and process piping
- Geothermal
- Agricultural piping
- Biomass heat sources
- Wood-fired boilers
- Solar
- Cooling towers & chilled water systems



A long-lasting system

R-flex is a pre-insulated, flexible, energy saving PEX piping system with a durable, waterproof outer cover. It consists of a long-lasting PEX carrier pipe or pipes surrounded by thick insulation layers, all contained in a unique double-wall outer casing for maximum protection. The flexibility and light weight of R-flex makes it far easier to install than rigid piping systems.

Superior protection

Surrounding the inner PEX carrier pipe are several layers of cross-linked polyethylene foam with a closed cellular structure. This unique design provides R-flex with a low water vapor absorption, enhanced R-value insulation, and an excellent resistance to extreme temperatures.

Most importantly, R-flex is able to maintain these insulation properties over time. Other insulation types, such as polyurethane (PUR) foam, can crush when the pipe is bent, causing them to lose their insulating properties.

Barrier PEX offers several advantages

- High resistance to corrosion and pressure at high temperatures
- Exceptionally high abrasion resistance
- Superb chemical resistance
- Excellent longevity at high temperatures

Flexible, fast, and easy

R-flex derives a unique benefit from the use of the polyethylene foam insulation and the double-wall outer shell; increased flexibility. This feature provides an advantage when running R-flex between buildings, around trench corners, or through wall penetrations.

Simple to install

Traditional carrier pipes, such as copper or black iron, require installers to cut and install transition fittings to work around an obstacle. With R-flex, installers no longer have to cut pipe and add connecting points. R-flex bends around the obstacle.

Design it with RadiantWorks Professional®

RadiantWorks Professional allows designers to properly determine the amount of R-flex required for a project and an estimated amount of transitional heat loss. Design it once. Design it right.



R-flex Single & Dual Coils

R-flex is a flexible pre-insulated PEX with a corrugated, double-wall HDPE cover suitable for direct burial. R-flex is manufactured in accordance with DIN 16892/16893, with a DIN 4726 oxygen barrier.

R-flex ratings: 200 °F at 80 psi; 180°F at 100 psi; 73°F at 160 psi

Determining size and amount of R-flex to order

R-flex Metric/Imperial equivalents

	Metric PEX I.D.	21.92 mm	26.2 mm	32.6 mm	40.8 mm
	Imperial PEX I.D.	0.863"	1.03"	1.28"	1.61"
	Metric PEX O.D.	25 mm	32 mm	40 mm	50 mm
	Imperial PEX O.D.	1"	1-1/4"	1-1/2"	2"
Single	160 mm Jacket O.D.			81012929	81012886
	200 mm Jacket O.D.				
Dual	125 mm Jacket O.D.	81012879	81012880		
	160 mm Jacket O.D.			81012882	
	200 mm Jacket O.D.				81012884
Approx. Max. Flow, gpm		12	17	25	40

	Metric PEX I.D.	51.6 mm	61.4 mm	73.6 mm	90.0 mm
	Imperial PEX I.D.	2.03"	2.42"	2.90"	3.55"
	Metric PEX O.D.	63 mm	75 mm	90 mm	110 mm
	Imperial PEX O.D.	2-1/2"	3"	3-1/2"	4"
Single	160 mm Jacket O.D.	81012887			
	200 mm Jacket O.D.		81012889	81012890	81012891
Dual	125 mm Jacket O.D.				
	160 mm Jacket O.D.				
	200 mm Jacket O.D.	81012885			
Approx. Max. Flow, gpm		70	90	140	200

NOTICE

To calculate the total length of R-flex needed, add 5% to the straight-line distance measured. This accounts for laying R-flex in a serpentine pattern. Also be sure to account for the length of all bends. Consult the R-flex Design and Installation Manual for more details.

R-flex Single & Dual Coils



R-flex Single — Custom lengths. Pre-insulated single oxygen barrier PEX with corrugated, double-wall HDPE cover.

Description	Model#	Order#	lbs.
40mm x 160mm OD Jacket, R-flex Single	RFS-40X160-1	81012951	1.56/ft.
50mm x 160mm OD Jacket, R-flex Single	RFS-50X160-1	81012952	1.67/ft.
63mm x 160mm OD Jacket, R-flex Single	RFS-63X160-1	81012953	1.87/ft.
75mm x 200mm OD Jacket, R-flex Single	RFS-75X200-1	81012954	2.8/ft.
90mm x 200mm OD Jacket, R-flex Single	RFS-90X200-1	81012955	3.18/ft.
110mm x 200mm OD Jacket, R-flex Single	RFS-110X200-1	81012956	3.79/ft.
Cut charge 25 ft. increments (i.e. 25', 75', 100', etc.)	RF-C75	81013128	
Cut charge for non-standard increments (i.e. 80', 105', 170', etc.)	RF-C150	81013129	

Maximum coil length is 328 ft.



R-flex Dual — Custom lengths. Pre-insulated dual oxygen barrier PEX with corrugated, double-wall HDPE cover.

Description	Model#	Order#	lbs.
1" x 125mm OD Jacket, R-flex Dual	RFD-1X125-1	81012957	1.09/ft.
32mm x 125mm OD Jacket, R-flex Dual	RFD-32X125-1	81012958	1.23/ft.
40mm x 160mm OD Jacket, R-flex Dual	RFD-40X160-1	81012959	1.77/ft.
50mm x 200mm OD Jacket, R-flex Dual	RFD-50X200-1	81012960	2.71/ft.
63mm x 200mm OD Jacket, R-flex Dual	RFD-63X200-1	81012961	3.12/ft.
Cut charge 25 ft. increments (i.e. 25', 75', 100', etc.)	RF-C75	81013128	
Cut charge for non-standard increments (i.e. 80', 105', 170', etc.)	RF-C150	81013129	

Maximum coil length is 328 ft.

R-flex Dust Caps & Shrink Caps

Single Pipe Dust Caps — Non-waterproof - for interior terminations.



Description	QTY	Model#	Order#	lbs.
40mmx1, 160mm OD, R-flex Single Pipe Dust Cap	1	RFDC-40X1X160	81012967	0.5
50mmx1, 160mm OD, R-flex Single Pipe Dust Cap	1	RFDC-50X1X160	81012934	0.5
63mmx1, 160mm OD, R-flex Single Pipe Dust Cap	1	RFDC-63X1X160	81012935	0.5
75mmx1, 200mm OD, R-flex Single Pipe Dust Cap	1	RFDC-75X1X200	81012936	0.5
90mmx1, 200mm OD, R-flex Single Pipe Dust Cap	1	RFDC-90X1X200	81012937	0.5
110mmx1, 200mm OD, R-flex Single Pipe Dust Cap	1	RFDC-110X1X200	81012938	0.5

Dual Pipe Dust Caps — Non-waterproof - for interior terminations.



Description	QTY	Model#	Order#	lbs.
1" x 2, 125mm OD, R-flex Dual Pipe Dust Cap	1	RFDC-1X2X125	81012939	0.5
32mm x 2, 125mm OD, R-flex Dual Pipe Dust Cap	1	RFDC-32X2X125	81012940	0.5
40mm x 2, 160mm OD, R-flex Dual Pipe Dust Cap	1	RFDC-40X2X160	81012941	0.5
50mm x 2, 200mm OD, R-flex Dual Pipe Dust Cap	1	RFDC-50X2X200	81012942	0.5
63mm x 2, 200mm OD, R-flex Dual Pipe Dust Cap	1	RFDC-63X2X200	81012943	0.5

Single Pipe Shrink Caps Waterproof — required for all direct burial connections in protective casings or inspection chamber.



Description	QTY	Model#	Order#	lbs.
40-50mm x 1, 160mm OD, R-flex Single Pipe Shrink Cap	1	RFSC-40-50X1X160	81012664	0.5
63mm x 1, 160mm OD, R-flex Single Pipe Shrink Cap	1	RFSC-63X1X160	81012540	0.5
75-110mm x 1, 200mm OD, R-flex Single Pipe Shrink Cap	1	RFSC-75-110X1X200	81012541	0.5

Dual Pipe Shrink Caps — Waterproof - required for all direct burial connections in protective casings or inspection chamber.



Description	QTY	Model#	Order#	lbs.
1" x 2 x 125mm OD, R-flex Dual Pipe Shrink Cap	1	RFSC-1X2X125	81012542	0.5
32mm x 2 x 125mm OD, R-flex Dual Pipe Shrink Cap	1	RFSC-32X2X125	81012543	0.5
40mm x 2 x 160mm OD, R-flex Dual Pipe Shrink Cap	1	RFSC-40X2X160	81012544	0.5
50mm x 2 x 200mm OD, R-flex Dual Pipe Shrink Cap	1	RFSC-50X2X200	81012545	0.5
63mm x 2 x 200mm OD, R-flex Dual Pipe Shrink Cap	1	RFSC-63X2X200	81012546	0.5

Debris Plugs for R-flex PEX — Use these to cap R-flex and keep jobsite debris out of the PEX tubing.



Description	QTY	Model#	Order#	lbs.
1", R-flex Pex Plug	1	RFPP-1"	81013021	0.5
32mm, R-flex Pex Plug	1	RFPP-32mm	81013022	0.5
40mm, R-flex Pex Plug	1	RFPP-40mm	81013023	0.5
50mm, R-flex Pex Plug	1	RFPP-50mm	81013024	0.5
63mm, R-flex Pex Plug	1	RFPP-63mm	81013025	0.5
75mm, R-flex Pex Plug	1	RFPP-75mm	81013026	0.5
90mm, R-flex Pex Plug	1	RFPP-90mm	81013027	0.5
110mm, R-flex Pex Plug	1	RFPP-110mm	81013028	0.5

R-flex Connections



Compression Adapters — PEX x MNPT, brass – for connecting R-flex to metal fittings. Included steel plate and bolt make it easy to slide collar over PEX.

Description	QTY	Model#	Order#	lbs.
1" x 1" MNPT, R-flex, Adapter, Comp	1	RFA-1X100MPT	81012552	1.0
32mm x 1" MNPT, R-flex, Adapter, Comp	1	RFA-32X100MPT	81012553	1.0
40mm x 1-1/4" MNPT, R-flex, Adapter, Comp	1	RFA-40X125MPT	81012554	1.5
50mm x 1-1/2" MNPT, R-flex, Adapter, Comp	1	RFA-50X150MPT	81012665	2.5
63mm x 2" MNPT, R-flex, Adapter, Comp	1	RFA-63X200MPT	81012556	3.5
75mm x 2-1/2" MNPT, R-flex, Adapter, Comp	1	RFA-75X250MPT	81012589	4.0
90mm x 3" MNPT, R-flex, Adapter, Comp	1	RFA-90X300MPT	81012558	7.5
110mm x 4" MNPT, R-flex, Adapter, Comp	1	RFA-110X400MPT	81012590	10.0

R-flex Bushings & Casings



Protective Sleeve Casing for R-flex — For waterproof sealing and insulating of straight connections. Includes 2 HDPE halves, insulation, sealer kit, and bolts. Must add shrink caps to seal ends of R-flex.

Description	QTY	Model#	Order#	lbs.
125-200mm pipes, R-flex Casing, Straight Sleeve	1	RFCS-125200	81012549	13.0



Protective Elbow Casing for R-flex — For waterproof sealing and insulating of elbow connections. Includes 2 HDPE halves, insulation, sealer kit, and bolts. Must add shrink caps to seal ends of R-flex.

Description	QTY	Model#	Order#	lbs.
125-200mm pipes, R-flex Casing, Elbow	1	RFCE-125200	81012548	21.0



Protective Tee Casing for R-flex — For waterproof sealing and insulating of tee connections. Includes 2 HDPE halves, insulation, sealer kit, and bolts. Must add shrink caps to seal ends of R-flex.

Description	QTY	Model#	Order#	lbs.
125-200mm pipes, R-flex Casing, Tee	1	RFCT-125200	81012550	26.0

R-flex Accessories



Protective Inspection Chamber for R-flex — Allows access to connections and/or valves. Includes HDPE chamber with 6 connection points, inspection lid, sealer kit and screws. Must add shrink caps to seal ends of R-flex, and jacket repair sleeves for sealing the R-flex to the chamber.

Description	QTY	Model#	Order#	lbs.
125-200mm pipes, R-flex Inspect Chamber	1	RFIC-125200	81012551	75.0



R-flex Jacket Repair Tape — To repair accidental damage to R-flex outer cover. Wrap the tape over damaged area and heat with heat gun.

Description	QTY	Model#	Order#	lbs.
3/4" x 33', R-flex Heat Shrink Repair Tape	1	RFRT-075X33	81012591	7.0

R-flex Accessories



R-flex Jacket Repair Sleeve — To repair accidental damage to R-flex outer cover. Slide the sleeve over damaged area and heat with heat gun.

Description	QTY	Model#	Order#	lbs.
125mm, R-flex Shrink Repair Sleeve	1	RFRS-125	81012592	1.0
160mm, R-flex Shrink Repair Sleeve	1	RFRS-160	81012593	1.0
200mm, R-flex Shrink Repair Sleeve	1	RFRS-200	81012594	1.0



R-flex Link Belt — Used when boring a hole in an existing wall. Seals wall penetrations between R-flex outer cover and wall.

Description	QTY	Model#	Order#	lbs.
125mm outer casing, R-flex Link Belt	1	RFLB-125	81012948	1.5
160mm outer casing, R-flex Link Belt	1	RFLB-160	81012949	5.0
200mm outer casing, R-flex Link Belt	1	RFLB-200	81012950	6.0

R-flex Specifications Chart

Specifications (conforms to DIN 16892, SDR-11)

	Order #	Description	PEX ID	PEX OD	Jacket OD	Bend Radius	Coil Length	Coil Diameter	Coil Height	Coil Weight	Fluid Cap. /100m (328ft)	Insulation Thickness	Casing R-Value	
Single	81012929	160/40 R-flex	32.6 mm (1.28")	40 mm (1.57")	160 mm (6.30")	350 mm (13.8")	100 m** (328 ft)	2300 mm (90.6")	850 mm (33.50")	232 kg (512 lbs)	83.00 L (21.93 gal)	47.5 mm (1.88")	6.79	
	81012886	160/50 R-flex	40.8 mm (1.61")	50.0 mm (1.97")		450 mm (17.80")				248 kg (547 lbs)	131.31 L (34.69 gal)	42.5 mm (1.68")	6.07	
	81012887	160/63 R-flex	51.6 mm (2.03")	63.0 mm (2.48")		550 mm (21.7")				278 kg (613 lbs)	208.76 L (55.15 gal)	37.0 mm (1.46")	5.27	
	81012889	200/75 R-flex	61.4 mm (2.42")	75.0 mm (2.95")	200 mm (7.90")	800 mm (31.5")			1400 mm (55.20")	416 kg (917 lbs)	296.67 L (78.37 gal)	52.0 mm (2.05")	7.4	
	81012890	200/90 R-flex	73.6 mm (2.90")	90.0 mm (3.54")		1100 mm (43.4")				473 kg (1,043 lbs)	426.02 L (112.55 gal)	44.0 mm (1.74")	6.28	
	81012891	200/110 R-flex	90.0 mm (3.55")	110.0 mm (4.33")		1200 mm (47.3")				564 kg (1,244 lbs)	638.41 L (168.65 gal)	34.0 mm (1.33")	4.84	
Dual	81012879	125/2x1 R-flex*	0.863" (21.92 mm)	1.125" (28.58 mm)	4.90" (125 mm)	11.80" (300 mm)	100 m** (328 ft)	2300 mm (90.60")	82.70" (2100 m)	27.60" (700 mm)	358 lbs (162 kg)	19.94 gal (75.46 L)	1.11" (28.0 mm)	4.01
	81012880	125/2x32 R-flex	26.2 mm (1.03")	32.0 mm (1.26")	125 mm (4.90")	300 mm (11.80")			2100 mm (82.70")	700 mm (27.60")	182 kg (402 lbs)	107.48 L (28.40 gal)	22.3 mm (0.88")	3.18
	81012882	160/2x40 R-flex	32.6 mm (1.28")	40.0 mm (1.57")	160 mm (6.30")	600 mm (23.70")			850 mm (33.50")	263 kg (580 lbs)	166.00 L (43.86 gal)	34.0 mm (1.34")	4.84	
	81012884	200/2x50 R-flex	40.8 mm (1.61")	50.0 mm (1.97")	200 mm (7.90")	800 mm (31.50")				1400 mm (55.20")	403 kg (889 lbs)	262.62 L (69.38 gal)	46.0 mm (1.81")	6.57
	81012885	200/2x63 R-flex	51.6 mm (2.03")	63.0 mm (2.48")		1200 mm (47.30")					464 kg (1,023 lbs)	417.52 L (110.30 gal)	33.0 mm (1.30")	4.69

* Pex pipe is certified to ASTM F876, SDR-9 dimensions.

** Custom lengths are available upon request. Contact distributor for details.

Radiant Fasteners & Tools



Foamboard Stapler — for installing radiant tubing in slab-on-grade or slab-over-slab applications.

Description	QTY	Model#	Order#	lbs.
Foamboard Stapler	1	P667425	81010025	5
Foamboard Staples, 1.5"	300	P667300-300	81000822	3
Foamboard Staples, 2.25"	300	P667350-300	81000825	3

The **Foamboard Stapler** is designed to staple 3/8" or 1/2" Onix, 3/8" to 5/8" PEX, and 3/8" to 5/8" RadiantPEX-AL to a wide variety of foam insulation boards. The stapler has been redesigned to reduce misfires and limit jams. The stapler comes fully assembled and uses both sizes of plastic staples. Use the shorter staples for 1" insulation boards, and the longer staples for 2" (or thicker) insulation boards. The Foamboard Stapler holds up to 120 staples. Reduce pipe installation time and increase productivity.

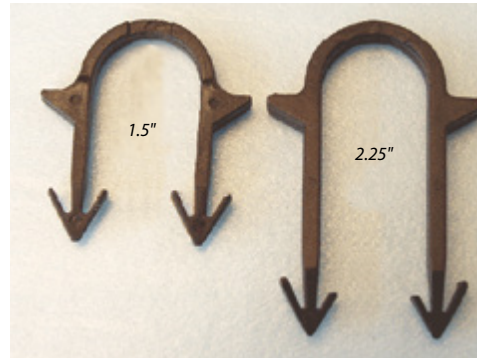

Two sizes of Foamboard staples.



RadiantPEX held fast by Foamboard staples.



FoamBoard Screw Clips

Description	QTY	Model#	Order#	lbs.
FoamBoard Screw Clips	100	PAC1620-100	81000848	1



Cable Ties — for tying all sizes of radiant tubing to rewire or rebar.

Description	QTY	Model#	Order#	lbs.
Cable Ties	1,000	667161-1000	81000580	4

Cable Ties are the old standby of the radiant slab installation business. Use Cable Ties wherever you want to attach Onix, PEX, or PAP to rewire or rebar. These high-strength nylon ties will not fail or pull apart like other ties.

Radiant Fasteners & Tools

Staple Guns

Description	QTY	Model#	Order#	lbs.
Staple Gun Kit (Onix and PEX)	1	668510	81000588	9

A single **Staple Gun Kit** now includes Staple Plates for 3/8" and 1/2" Onix as well as 3/8" and 1/2" PEX. Watts Radiant Staple Guns are professional tools that do an excellent job stapling Onix, RadiantPEX+, RadiantPERT, and RadiantPEX-AL(PAP) in both staple-up and thin slab projects.

Staple Gun Accessories

Description	QTY	Model#	Order#	lbs.
Extension Arm Kit	1	668515	81000592	4
Staple Plate Replacement (Onix)	1	668520	81005498	1
Staple Plate Replacement (PEX/PAP)	1	P668520	81005497	1

Already have one of our staple guns? Order an **Extension Arm Kit**. Also, if you damage the plate on the gun, please order from the replacement numbers above.

Staples — for Onix and PEX/PAP staple guns.

Description	QTY	Model#	Order#	lbs.
Staples for Onix and PEX/PAP	1,660	668018-1660	81004290	4

We highly recommend Watts Radiant staples, as they offer straight shooting and trouble-free usage. Save yourself trouble and use the best. These staples only work with 3/8" and 1/2" Onix, 3/8" and 1/2" RadiantPEX /RadiantPERT, or 3/8" and 1/2" RadiantPEX-AL(PAP) tubing.

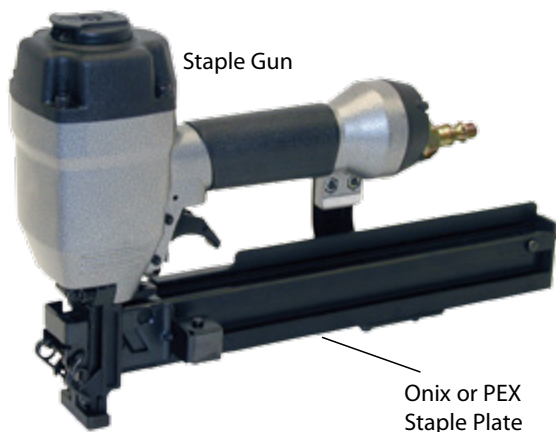

Staple Gun
Extension Arm

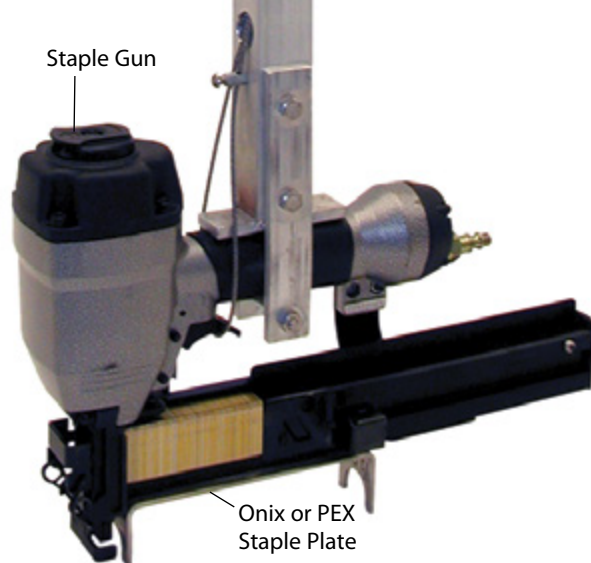

Fasteners and Tools



Mid-run Bend Supports — for bending RadiantPEX or RadiantPEX-AL without kinking.

Description	QTY	Model#	Order#	lbs.
1/2" Mid-run Bend Supports	10	PSBM33X-10	81005399	4
3/4" Mid-run Bend Supports	10	PSBM55X-10	81005400	5

Mid-run Bend Supports help PEX make 90° turns in walls and joist cavities. These can also be used as Terminal Bend Supports. 1/2" mid-run supports can snap into stubout brackets.



Terminal Bend Supports — for transitioning and protecting radiant tubing at ends.

Description	QTY	Model#	Order#	lbs.
3/8", 1/2" Terminal Bend Supports	10	PSB23X-10	81005401	4
3/4" Terminal Bend Supports	10	PSB45X-10	81005402	5

Terminal Bend Supports are plastic elbows that are used near the completion of PEX circuits to help the tubing make smooth transitions out of the slab and up to the manifolds.



Triple-track Railway™ — for securing smaller sizes of radiant tubing.

Description	QTY	Model#	Order#	lbs.
Railway, 4 ft. length	10	P100500-10	81000780	10

The **Triple-Track Railways** securely hold several sizes of radiant tubing where rewire or rebar are not used. Use triple-tracks for: 3/8" Onix; 3/8", 1/2", and 5/8" RadiantPEX/RadiantPERT; and 3/8", 1/2" and 5/8" RadiantPEX-AL Applications include concrete slabs, thinslabs, sand beds, and subgrade gravel layers. Triple-Track Railways are sold in 4' lengths. Triple-Track Railways allow almost any spacing you may need — 6", 9", 12", 15", or 18". Figure one railway approximately 8 square feet.

3/8" NailTite



NailTites™ — for securing Onix or PEX to subfloors using a hammer.

Description	QTY	Model#	Order#	lbs.
NailTites (3/8" Onix; 3/8" or 1/2" PEX/PAP)	100	691060-100	81000690	1

NailTites are used to hold Onix and PEX wherever a staplegun cannot get into a tight area. These NailTites are strong and easy to use. They work for 3/8" Onix, 3/8" and 1/2" PEX, or 3/8" and 1/2" RadiantPEX-AL.



UnderFloor LockDown™ — for 3/8" and 1/2" RadiantPEX/RadiantPERT and RadiantPEX-AL underfloor applications.

Description	QTY	Model#	Order#	lbs.
LockDown Fastener	100	P667100-100	81000818	1



Our **LockDown** fastener is designed specifically for under-floor PEX applications. Its loose hold allows PEX to move during expansion and contraction of the tubing. The LockDown won't pop open like other similar clips you may have seen or tried. Use LockDowns for attaching 3/8" or 1/2" PEX; do not use it for 5/8" PEX as it will fit too tightly. Order five LockDowns for 10' of PEX. Follow all Installation Guidelines carefully.

Fasteners and Tools



FlexPlate™ — flexible, graphite plates install 40% faster than aluminum plates, with 50% higher thermal conductivity! Better utilize high efficiency, low temperature heat sources such as condensing boilers, geothermal, or solar.

Description	QTY	Model#	Order#	lbs.
FlexPlate , 1/2" x 4'	20	FPLT04500-20	81012401	13

These heat transfer plates are made using a patented, highly conductive graphite material. Used in underfloor, wall, ceiling, or above floor applications, FlexPlates require lower water temperatures and produce more uniform floor temperatures than extruded aluminum plates. FlexPlates are lightweight, flexible, cut easily with scissors or a utility knife, easy to staple, and don't have any sharp edges that require grinding. For 1/2" RadiantPEX+/RadiantPERT or RadiantPEX-AL. Measures 6" wide x 4' long.

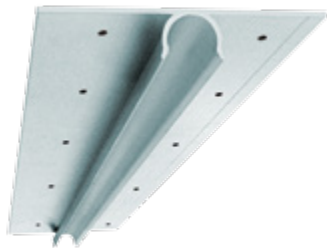

Extruded Aluminum PEX Plates — plates for RadiantPEX+ or RadiantPERT underfloor and sandwich applications.

Description	QTY	Model#	Order#	lbs.
Ext. Alum. PEX Plate, 3/8" x 4'	20	P700350-20	81005039	24
Ext. Alum. PEX Plate, 1/2" x 4'	20	P700250-20	81005038	26

These plates are an extruded aluminum plate with pre-drilled holes measuring 3-1/2" wide by 4 ft. long. Tubing snaps into channel, making installation fast and easy. No silicone glue is required. The channel's tight grip eliminates annoying ticks and clicks as the PEX expands and contracts.



Stamped Aluminum PEX Plates — for underfloor and sandwich applications.

Description	QTY	Model#	Order#	lbs.
Stamped Alum. Plates for 1/2" PEX or PAP	100	P700524-100	81000843	22

These plates are a stamped aluminum plate measuring 5" x 24". You'll need about four plates per 10' of tubing. Follow our Installation Guidelines very carefully when using these plates.



Professional Tubing Cutter — ratchet-style cutter.

Description	QTY	Model#	Order#	lbs.
Professional Tubing Cutter	1	PTC200	81001393	1

This **Professional Tubing Cutter** cuts tubing to length. This cutter is made of all-metal, heavy-duty construction and is designed for the rigors of daily jobsite use. Cuts up to 1-1/2" PEX, or 1" PAP.



SqueezeTite™ Pliers — for installing SelfTite clamps on Onix.

Description	QTY	Model#	Order#	lbs.
SqueezeTite Pliers	1	669100	81000600	1

This **SqueezeTite Pliers** are locking caliper pliers that allow worry-free handling of all sizes of our SelfTite clamps. This uniquely designed tool prevents the SelfTite clamp from accidentally sliding free, as could happen with a standard pair of pliers or channel locks. With SqueezeTite Pliers, SelfTite clamps can be locked in the open position, freeing both hands to secure the Onix to the barb.

Fasteners and Tools



Onix Unwinder — for unwinding Onix tubing.

Description	QTY	Model#	Order#	lbs.
Onix Unwinder	1	669231	81000602	18

Watts Radiant's **Onix Unwinder** allows Onix coils to be quickly and easily unwound for faster hose layout on the jobsite. The center post allows the Onix coil to move around without sliding off the Unwinder. Heavy-duty ball-bearing construction means years of use and easy turning.

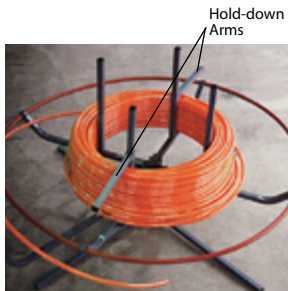

PEX Unwinder — for unwinding RadiantPEX, RadiantPERT, and RadiantPEX-AL.

Description	QTY	Model#	Order#	lbs.
PEX Unwinder, Standard	1	P669231	81000838	35

Our **PEX Unwinder** handles coils up to 1" PEX. The coil sits on the tripod and is held in place as it unwinds with four guide-bars. The PEX feeds through a guide-ring on top of the unwinder. The PEX Unwinder comes complete with two hold-down arms.

RadiantPEX Tools



CrimpMaster™ Tool — for use with PEX tubing and copper Crimp Rings.

Description	QTY	Model#	Order#	lbs.
1/2" CrimpMaster Tool	1	PCMT33	81001153	3
3/4" CrimpMaster Tool	1	PCMT55	81001154	3

The CrimpMaster is a smaller, more compact crimping tool. The tool arms only need to open 6", making it easy to get into tight spaces. Buy one tool for each size of PEX fittings.



Ratcheting PEX CinchTool — squeeze CinchClamps with one hand (for PEX and PERT only).

Description	QTY	Model#	Order#	lbs.
Ratcheting CinchTool	1	PCCCT6	81009461	4

Use this heavy-duty Ratcheting CinchTool to cinch all sizes of stainless steel CinchClamps. This is the best tool for 3/4" and 1" CinchClamps. Cinches can be done with one hand (you may need two hands for 1" clamps). Just squeeze the tool until the indicator window shows the connection is complete. Then release the quick-release knob. It's that simple. The tool comes complete with holster and adjustment tools. Meets ASTM-F2098 specifications.



PEX CinchTool™ — One simple tool installs all sizes of CinchClamps™ (for PEX and PERT only).

Description	QTY	Model#	Order#	lbs.
CinchTool	1	PCCCT-2	81009709	3

PEX connections take only seconds with the **CinchTool**. Great for those hard-to-reach spaces. Ratchet design releases only when the CinchClamp tab is properly pinched, thus ensuring a leak-proof connection. Meets ASTM F-2098 specifications.

RadiantPEX Tools



CrimpAll™ Tool Kit — for use with PEX or PERT tubing and copper Crimp Rings.

Description	QTY	Model#	Order#	lbs.
15" CrimpAll Tool Kit, 3/8", 1/2", 5/8", 3/4"	1	PCCRT2346	81003038	6
19" CrimpAll Tool Kit, 1", 1-1/4"	1	PCCRT57	81009111	7

Interchangeable crimping jaws make the CrimpAll Tool Kit a great value. One tool kit allows crimping of multiple sizes of RadiantPEX+. The 15" CrimpAll Kit has four crimping jaws: 3/8", 1/2", 5/8", and 3/4". The larger 19" CrimpAll Kit gives more leverage for crimping 1" and 1-1/4" PEX and fittings. A tough plastic case helps keep all the crimping tools in one place. The kit includes the CrimpAll tool, interchangeable jaws, a Go/No-Go crimp gauge, and adjustment tools.

NOTICE

The jaws for the 15" tool are not interchangeable with the 19" tool. Also, the CrimpAll can only be used for fastening crimp rings over crimp fittings and PEX/PERT tubing. Do not use it for press fittings or RadiantPEX-AL tubing as the connection will leak.



Go/No-Go Gauge



Adjustment Tools



Replacement CrimpAll™ Parts

Description	QTY	Model#	Order#	lbs.
Go/No-Go Gauge	1	PCGA234P	81001123	1
Go/No-Go Gauge for 1" PEX	1	PCGA5P	81001124	1
Adjustment Tools	1	PCCRT1001	81003717	1

RadiantPEX Crimping Power Tool Jaws for Large Diameter PEX — For crimping RadiantPEX with crimp fittings and copper crimp rings

Description	QTY	Model#	Order#	lbs.
Rems Crimp Jaw 1-1/4" F1807	1	PCRT6	81003660	4
Rems Crimp Jaw 1-1/2" F1807	1	PCRT7	81009948	5
Rems Crimp Jaw 2" F1807	1	PCRT10	81017084	5

Power Tool RadiantPEX Crimp Jaws are used for crimping PEX tubing and fittings with copper crimp rings. These jaws fit the REMS Akku-Press and PowerPress-E power tools, as well as the Ridgid 330-B power tool.

RadiantPEX-AL Tools & Accessories



RadiantPEX-AL Pipe Reamers (Plastic reamer and T-reamer)

Description	QTY	Model#	Order#	lbs.
3-sided Reamer, 3/8", 1/2", 3/4"	1	RLR05-060812	81010841	1
3-sided Reamer, 5/8", 3/4", 1"	1	RLR-101216	81011431	1

SmartTrac™

Radiant Panel Solution

Radiant, the Smart Way

- Deliver quiet, even, comfortable heat
- Configure for any space
- Fast and easy installation
- 80% lighter than thin slab
- Works with any floor covering
- Designed for 3/8" PEX/PERT tubing

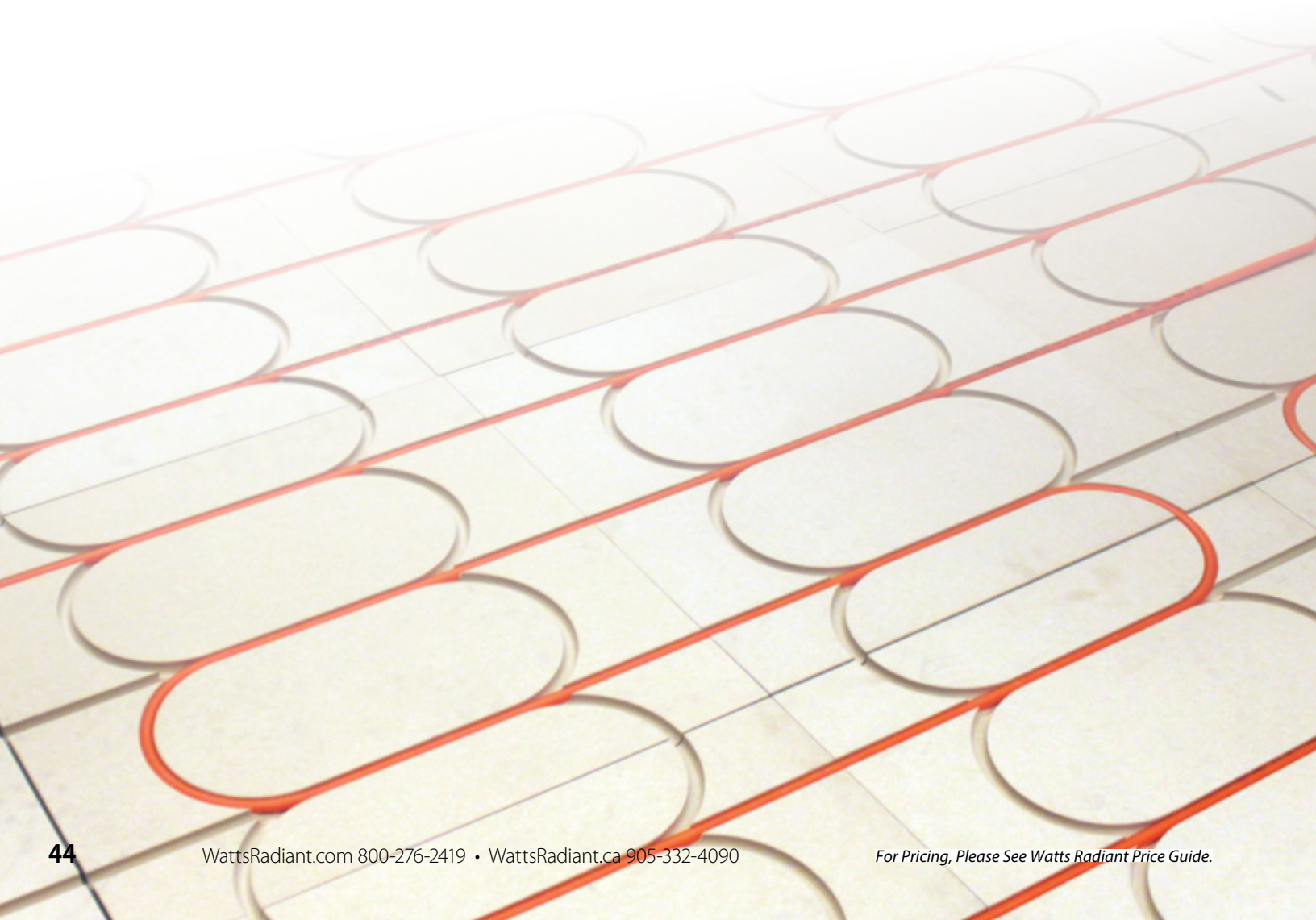

Anatomy of the SmartTrac™ system

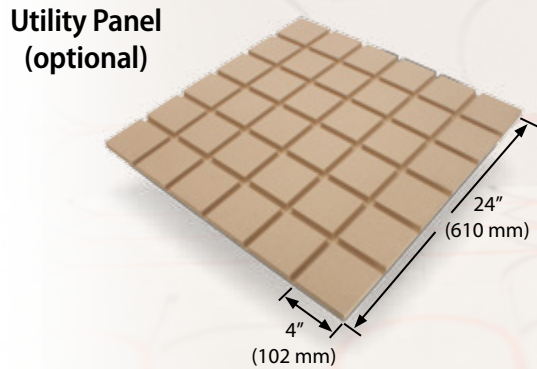
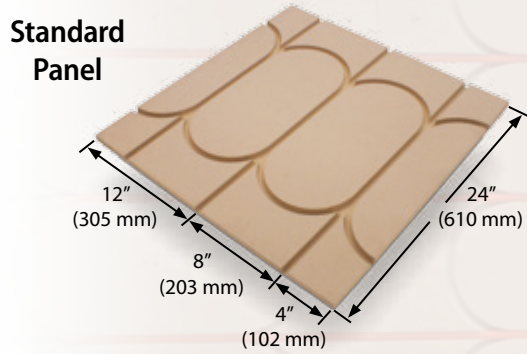

SmartTrac™ system works under:

Hardwood...

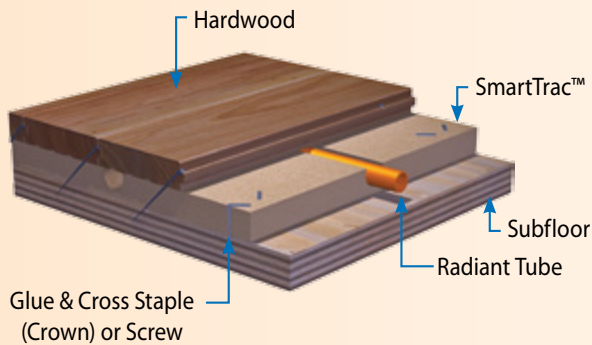

Tile...

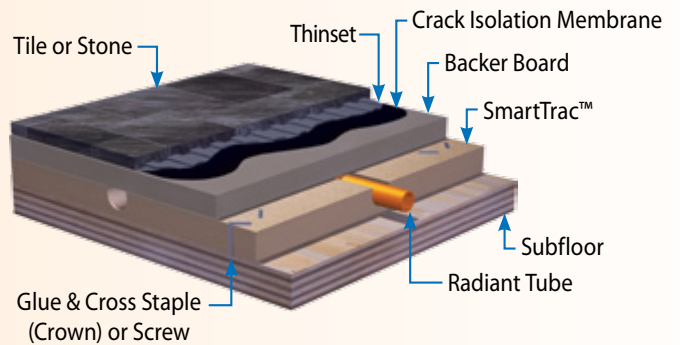

and many other flooring choices

SmartTrac Panels

Description	QTY	Model#	Order#	lbs.
Standard Panel	132	ST-838-ONE	81016822	1,188
Standard Panel	5	ST838-ONE-5	81019329	45
Utility Panel (Optional)	5	ST-838-UTILITY	81016823	45

Thermostats, Mixing Controls and Sensors



24V-powered

Radiant Thermostat 519

Description	QTY	Model#	Order#	lbs.
Thermostat 519 Air/Floor Digital 24V stat/w sensor	1	300152	81016550	1

The Radiant Thermostat 519 accurately controls the room and/or floor temperature for a hydronic heating zone using Pulse Width Modulation (PWM) technology. Simple up and down buttons and a display with large type makes this thermostat easy to read and use. The included Floor Sensor 079 enhances comfort and allows for floor temperature limiting. This easy to install thermostat is a direct replacement for the DualTemp Thermostats.



Adaptor Plate 012

Description	QTY	Model#	Order#	lbs.
Adaptor Plate 012	1	300158	81016733	1

The Adaptor Plate 012 covers the paint ring left behind when replacing other thermostats, so that no patching or painting the wall is required. The 012 also allows a thermostat to be installed onto a single gang electrical box. The 012 package includes screws for mounting the adaptor plate and the device that attaches to it.



Floor Sensor 079

Description	QTY	Model#	Order#	lbs.
Floor sensor 079 (extra)	1	300153	81016551	1

The Floor Sensor 079 is commonly used for floor temperature sensing in floor heating applications. The thin casing allows for retrofit installation between tile spaces if necessary. This sensor is designed to provide a thermostat with the ability to maintain a minimum slab temperature, or help to limit the maximum slab temperature.



Mixing Control 356

Description	QTY	Model#	Order#	lbs.
Mixing Control 356 Variable Speed	1	300147	81000134	2

The Mixing Control 356 is designed to operate a mixing pump to control the temperature in a hot water heating system using Outdoor Temperature Reset. It can be used in applications ranging from in-floor radiant to commercial baseboard systems adding boiler protection with full reset. It provides mixing by speeding up or slowing down a single permanent capacitor (standard wet rotor) circulator.



Universal Sensor 082

Description	QTY	Model#	Order#	lbs.
Universal Sensor 082	1	300156	81016554	1

The Universal Sensor 082 is a 10-k Ω -temperature sensor designed to be strapped onto a pipe. It is most commonly used to monitor supply and return water temperatures. This product has a brass sleeve for fast response, a wide operating range, an indent to allow pipe strap on installation, and 8 ft (2.4 m) of 2-conductor wire.

Zone Valve/Actuator Controls

“Plug-and-Play” connection makes it easy to add more zones



Master Valve/Actuator Control unit mated to 4-Zone and 6-Zone Slave Control units

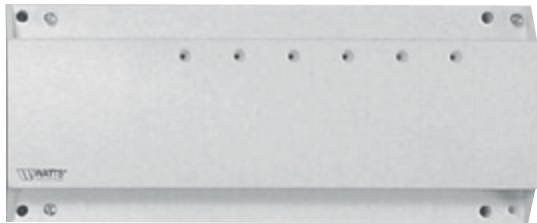

Master Valve/Actuator Controls

Description	QTY	Model#	Order#	lbs.
Valve/Actuator Control, Master, 4-zone	1	P-2329	81005192	2
Valve/Actuator Control, Master, 6-zone	1	P-2331	81005190	2
60 VA Transformer	1	P-3231	81009509	2

Our **Master Valve/Actuator Controls** are intended to control Watts Radiant Electrothermal Actuators, or any 24-VAC actuator or valve that draws 5 VA or less. The number of actuators controlled depends on the separate 24-VAC external transformer (not included, order separately) powering the system. An external 40-VA 24-VAC transformer can control 12 actuators maximum. Up to 18 actuators maximum can be controlled with a 60-VA 24-VAC transformer. Order Slave Valve/Actuator Controls separate for additional zones.

Master Controls are fused and include two end switches, each rated at 8A. Actuators are switched by triacs, for quiet, safe, reliable electronic operation. Mounting is by DIN rail or surface mount to a wall. The 60 VA transformer is surface mount.



4-zone Slave Valve/Actuator

Slave Valve/Actuator Controls — connect to Master Controls to expand the number of zones.

Description	QTY	Model#	Order#	lbs.
Valve/Actuator Control, Slave, 4-zone	1	P-2330	81005246	2
Valve/Actuator Control, Slave, 6-zone	1	P-2332	81005191	2

Valve/Actuator Slave Controls add extra zone capability to 4-zone or 6-zone Master Control Units. Like the Master Controls, they are intended to control Watts Radiant Electrothermal Actuators, or any 24-VAC actuator that draws 5 VA or less. The number of actuators controlled depends on the 24-VAC external transformer (not supplied) powering the system.

Up to two additional 4-zone or 6-zone Slave Controls can be added to a Master Control. No field wiring is required between — Masters and Slaves simply plug into each other (see top of page).

Each additional 40-VA 24-VAC transformer capacity can control an extra 12 actuators maximum; 18 actuators maximum with an additional 60-VA 24-VAC transformer. Actuators are switched by triacs, for safe, quiet, reliable electronic operation. Mounting is by DIN rail or surface mount to a wall.



6-zone Slave Valve/Actuator

Snow Melting Controls



Snow Melting Control 654

Description	QTY	Model#	Order#	lbs.
Snow Melting Control 654	1	300154	81016552	1

The Snow Melting Control 654 is designed to operate hydronic or electric equipment to melt snow or ice from a driveway, loading dock, sidewalk, patio, helipad or car wash bay. The snow melt surface temperature is controlled using slab outdoor temperature reset to reduce operating energy costs. The 654 provides automatic start and stop when used with the Snow / Ice Sensor 090. Automatic start with a timed stop is available when used with the Snow Sensor 095. The 654 can operate a dedicated hydronic boiler or a mixing valve. Isolation relays are required to operate line voltage pumps. Electric systems require a separate GFCI and electrical relay contactor.



Snow Sensor 095

Description	QTY	Model#	Order#	lbs.
Snow Sensor (air) 095	1	300155	81016553	1

The Snow Sensor 095 is an aerial mounted sensor for use together with Snow Melting Controls to automatically detect falling snow to start the snow melting equipment. System stop is provided by the control's timer or by manual disable. Mounted to a 1/2" metal or PVC conduit or pole, the 095 is well suited to adding automatic start when retrofitting an existing snow melt system.



Snow/Ice Sensor 090

Description	QTY	Model#	Order#	lbs.
Snow/Ice Sensor (in slab) 090 w/65 ft cable	1	300108	81005661	4

The Snow/Ice Sensor 090 is an in ground sensor used with Watts Radiant snow melting controls to automatically detect snow or ice on a driveway or walkway. The 090 has 65 ft (20 m) of wire. This product can be used in applications ranging from residential driveways to commercial building fronts such as emergency access entries. This sensor allows Watts Radiant snow melting controls to automatically operate the snow/ice melt system only when snow or ice is present, while also providing slab temperature feedback to the control.



Snow/Ice Sensor Socket 091

Description	QTY	Model#	Order#	lbs.
Snow/Ice Sensor Socket 091	1	300111	81003753	2

The Snow/Ice Sensor Socket 091 is designed to provide a mounting solution for the Snow/Ice Sensor 090. It is installed directly into a concrete slab when the slab is poured, so that the 090 can be installed into it once dry.



Slab Sensor 072

Description	QTY	Model#	Order#	lbs.
Slab Sensor 072	1	300141	81007203	1

The Slab Sensor 072 is designed to measure temperature in outside snow melting slabs. It has a high-density polyethylene (HDPE) sleeve, which is designed for use in conduits, soils, or concrete, as it is suitable for direct burial. This product is supplied with 20 ft (6 m) of 2-conductor cable.



Snow Melting Plaque — Permanent plaque to indicate where a snow melting system has been installed.

Description	QTY	Model#	Order#	lbs.
Snow Melting Plaque	1	100123HW	81012651	2



IsoTherm — a pre-piped, pre-wired pump and mix valve for 1" Stainless Steel Manifolds.

Description	QTY	Model#	Order#	lbs.
Isotherm with Safety Aquastat	1	D3803995	81005361	15

Order isolation ball valves to help in purging air at start-up.

Order transitional fittings separately for transition to supply and return piping.

The **IsoTherm** is a compact, efficient pre-piped and pre-wired pump and mixing valve control designed to connect to Watts Radiant's 1" Stainless Steel Manifolds.

When combined with Watts Radiant's electro-thermal actuators and actuator valve controls (not included), a complete trouble-free system is created, serving from 1 to 12 zones and delivering up to 50,000 Btu/h (maximum of 68,000 Btu/h with a minimum boiler temperature of 160°F).

The mixing valve has a standard temperature range of 113° to 140°F (45° to 60°C). The unit is factory set at 131°F (55°C). The valve is easily adjustable and locks in position with a "click-stop" device, preventing temperature drift.

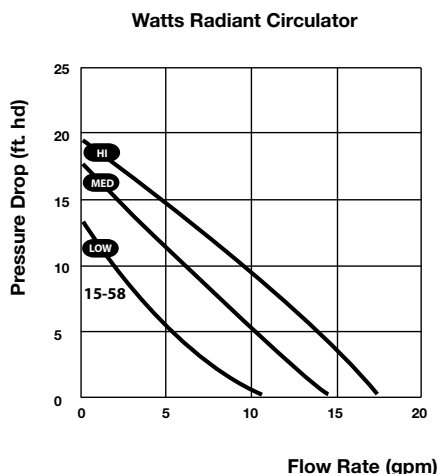

A three-speed 1/25-HP pump comes pre-installed and pre-wired, taking the guesswork out of field installations. The Watts Radiant 1558 circulator will flow approximately 10 gpm at 10 ft. hd. This unit is ready — right out of the box!

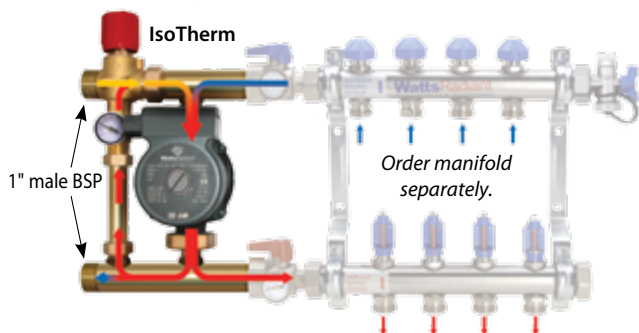

Pressure Differential By-pass Valve — for 1" Stainless Steel Manifolds.

Description	QTY	Model#	Order#	lbs.
Pressure Differential By-pass Valve	1	D4402050	81005345	5

Order manifold End Cap and/or Vent-and-Purge Assembly separately.

The Pressure Differential By-pass Valve for 1" Stainless Steel manifolds eliminates possible water velocity noise and water hammer. With this valve, pumps cannot exceed the actuator close-off pressure. Pump life increases because of minimal pressure surging as actuators open and close. Correct and constant flow is always ensured regardless of the number of actuators open.

This Pressure Differential By-pass Valve installs directly on the 1" Stainless Steel manifolds. This valve adjusts from 0.7 psi (1.6 feet water) to 10.3 psi (23.8 feet water) using a graduated knob. Water by-pass capacity is 1.2 gpm to 9 gpm. The knob is set and locked with a set screw to prevent tampering.





Zone Valve Body & Actuator Kit

Description	QTY	Model#	Order#	lbs.
3/4" Valve Body Only	1	703022	81009858	1
3/4" Valve Body & Actuator Kit	1	PZ656104A	81011158	2

Watts Radiant's 3/4" sweat zone valve is comprised of a brass body with stainless steel internal springs and EPDM seals, allowing for extended longevity in adverse conditions. CV=2.8

Each valve is compatible with our existing thermal actuator, which is used on the Stainless Steel manifold series.

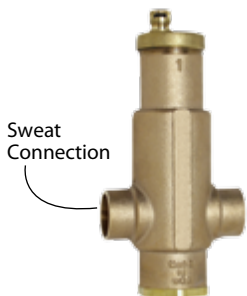

Air Remover

Description	QTY	Model#	Order#	lbs.
1" Sweat Air Remover	1	AS-MB-S-100-RAD	81015815	5
1-1/4" Sweat Air Remover	1	AS-MB-S-125-RAD	81015816	7

Air Removers are required in any closed-loop hydronic system to remove air from the system and keep it out after the system has been purged.

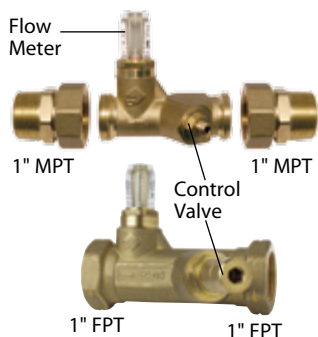

FlowGuards — circuit setters with visual readout.

Description	QTY	Model#	Order#	lbs.
0.5–4 GPM FlowGuard, 1" MPT half unions	1	D3499375	81001979	4
1–13 GPM FlowGuard, 1" FPT ends	1	D3499480	81001980	2

FlowGuards are a commercial-quality, non-electronic flow indicator and flow setter. Made of durable, cast brass construction, these units give accurate visual flow indication in GPM. With the ability to set fluid flow, the FlowGuards allow zone-by-zone control and optimization. No special training or electronic instrumentation required.

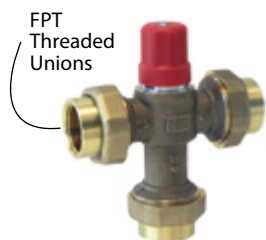

MixTemp™ 160 Valves — 100° to 160°F range.

Description	QTY	Model#	Order#	lbs.
3/4" MixTemp 160 (Cv = 3.1)	1	LF703075	81016965	2
1" MixTemp 160 (Cv = 3.2)	1	LF703100	81016966	2

These durable, non-electric, brass-bodied **MixTemp 160 Valves** have the widest (100°–160°F) temperature ranges available in a small valve. The valve comes complete with threaded unions for ease of service. All connections are FPT threads. MixTemp valves can be used in both primary/secondary and direct piping applications with at least one pump per valve. These are not to be used for potable water applications as they are not anti-scald valves.

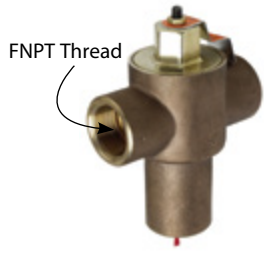

AllTemp™ Mixing Valve — 100° to 200°F range.

Description	QTY	Model#	Order#	lbs.
1-1/4" All-Temp (Cv = 6.1)	1	703200	81000716	7

These simple, durable, non-electric **AllTemp Mixing Valves** feature a rugged cast-bronze body with liquid-filled copper thermostatic actuators. All connections are FPT threads. These valves are sensitive to the slightest change in mixed water temperature. These valves can be used in both primary/secondary and direct piping applications with at least one pump per valve. These are not to be used for potable water applications as they are not anti-scald valves.



Watts Combination Temp./Press. Gauge — bottom mount, 32°–248°F/0–50 PSI.

Description	QTY	Model#	Order#	lbs.
Combination Gauge, 32°–248°F/0–50 PSI	1	705075	81004202	1

These gauges combine a graduated temperature gauge and pressure gauge in ONE unit! Features metal construction for ruggedness. An ingenious self-sealing 1/2" MPT brass well is included so minimal system fluid is lost if the gauge is ever removed from the system.

A manually-adjustable pointer can be used to track temperature or pressure changes.

These gauges come in two styles: either bottom mount or back mount for mounting convenience. Install one of these gauges and monitor your system easily, efficiently, and reliably.



Watts Combination Temp./Press. Gauge — back mount, 60°–320°F/0–200 PSI.

Description	QTY	Model#	Order#	lbs.
Combination Gauge, 60°–320°F/0–200 PSI	1	705100	81003656	1



Temperature Gauge

Description	QTY	Model#	Order#	lbs.
Temperature Gauge, 0°–200°F	1	LF704621	81016967	1

These **Temperature Gauges** are 3" in diameter. They are made with a continuously welded, stainless steel housing with a 2-1/2" long stem and 1/2" NPT threads. The black-on-white dials are marked in °F and °C, and are protected by a rugged crystal lens. Back mounted.



Choose Watts Radiant pre-built mechanical panels for simplified specification & installation

Remove unpredictability and ensure the installed system is the same as the designed system. Panels and skids offer a factory-built, professional appearance, quick installation and a factory warranty.

ThermalPro™

- Boiler stations / 3-way mixing option
- Headers to connect 2 to 5 stations
- Low loss header options

ThermalPro™ Standard

- Zone Panels with or without actuators
- Built-in pump, control and 3-way mixing options

HydroControl & HydroSkid

- Custom mechanical systems fabricated to your specifications
- Commercial, industrial and institutional solutions
- Quality components

ThermalPro™

Boiler Stations Manifold Stations Accessories

The **ThermalPro™** boiler connection station is a compact, pre-piped mechanical system complete with circulator, isolation ball valves, thermometers, pressure bypass valve, sensor wells for control sensors, and multi-segmented insulation to control heat loss, and, on mixed stations, a 24 volt, 3-way mixing valve. ThermalPro™ boiler stations are designed to speed up installation by connecting directly to a hydronic heating system providing a complete and compact piping and mixing system in a box. ThermalPro™ boiler stations can handle up to 150,000 Btu/h.

ThermalPro™ non-mixed boiler stations can provide a wide range of control to accommodate many project applications from hydronic air handlers to baseboards. ThermalPro™ mixed boiler stations are designed to provide low temperature floor heating by connecting the mixing valve to the mixing control of your choice (not provided). The mixing valve is equipped with a manual adjustment knob, which can be used for single zone operation or temporary control of a multi-zone low temperature floor heating system.

NEW

ThermalPro Boiler Stations



Description	Order Number	Model Number
ThermalPRO Non-Mixed Boiler Stations		
ThermalPro Non-Mixed Boiler Station with UPS 25-58 Circulator	81015287	10004401
ThermalPro Non-Mixed Boiler Station with UPS 25-99 Circulator	81015288	10025566

***Some items may be special order**

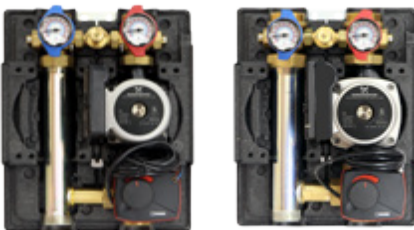

ThermalPro Mixing Boiler Stations		
ThermalPro Mixing Boiler Station 7.31Cv with UPS 25-58 Circulator	81015290	D700101P
ThermalPro Mixing Boiler Station 9.28 Cv with UPS 25-58 Circulator	81015291	D700107P
ThermalPro Mixing Boiler Station 11.6 Cv with UPS 25-99 Circulator	81015292	D700207P

***Some items may be special order**

Note: For stand alone applications, (no station header used) 1 pair of Adapters (81010373 or 81010374) must be ordered

ThermalPro™ Boiler Station Accessories



Description	Order Number	Model Number
-------------	--------------	--------------

Station Headers

VB32-2 Module Boiler Station Header	81015294	10025900
VB32-3 Module Boiler Station Header	81015295	10026901
VB32-4 Module Boiler Station Header	81015291	10026672
VB32-5 Module Boiler Station Header	81015297	10020931
WHVB Mounting Bracket	81015298	10026388

Some items may be special order

Primary/Secondary Hydraulic Separators

22GPM Hydraulic Separator (low loss header)	81010375	D700108
44GPM Hydraulic Separator (low loss header)	81011865	D700109

Some items may be special order

ThermalPRO™ Boiler Stations are versatile

Boiler Stations
(see previous page
for model options)

Station Headers
(for 2 to 5 Boiler
Stations)

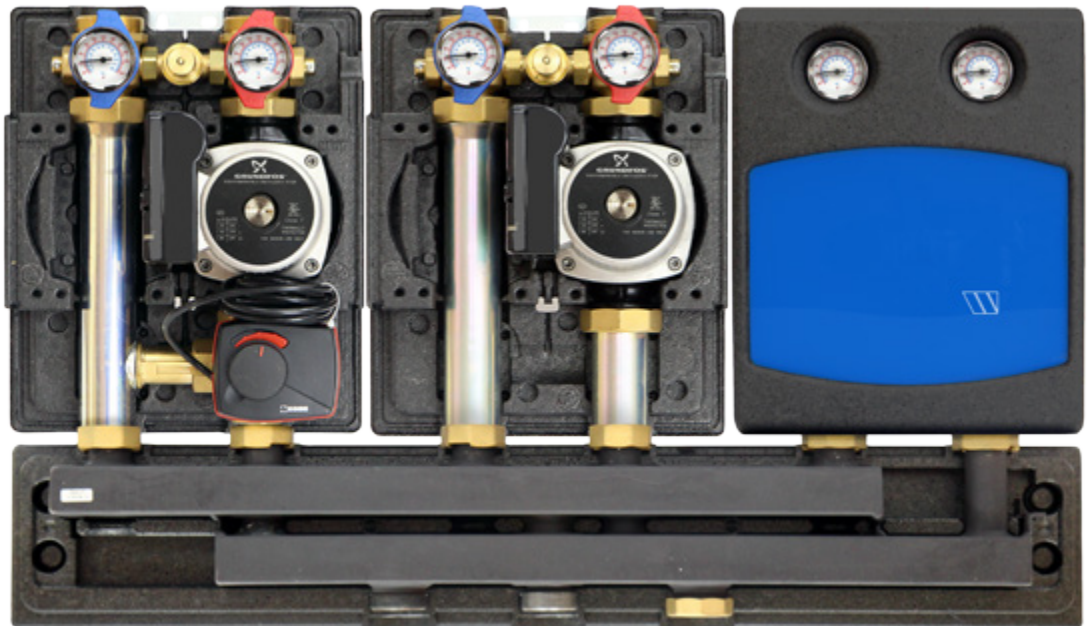

ThermalPro™ Boiler Station Accessories

Description	Order Number	Model Number
ThermalPro Accessories and Parts		
WHVB Station Mounting Bracket	81015298	10026388
1-1/4" FNPT NA Tailpiece Set (2)	81010373	D700105
1-1/4" Sweat Union NA Tailpiece Set (2)	81010374	D700106
Replacement Mixing Valve 7.32Cv	81010857	3149020
Replacement Mixing Valve 9.28Cv	81010858	3149023
Replacement Mixing Valve Motor 24v	81010859	9119162

Some items may be special order

Order Qty of 4 x 81010373 [1-1/4" FNPT NA Tailpiece Set (2)] or 81010374 [1-1/4" Sweat FNPT NA Tailpiece Set (2)] for the 22 GPM and Qty of 4 x 81015246 (2" NPT x BSP adapter) adapters for the 44 GPM.

Typical ThermalPRO™ Piping Configuration

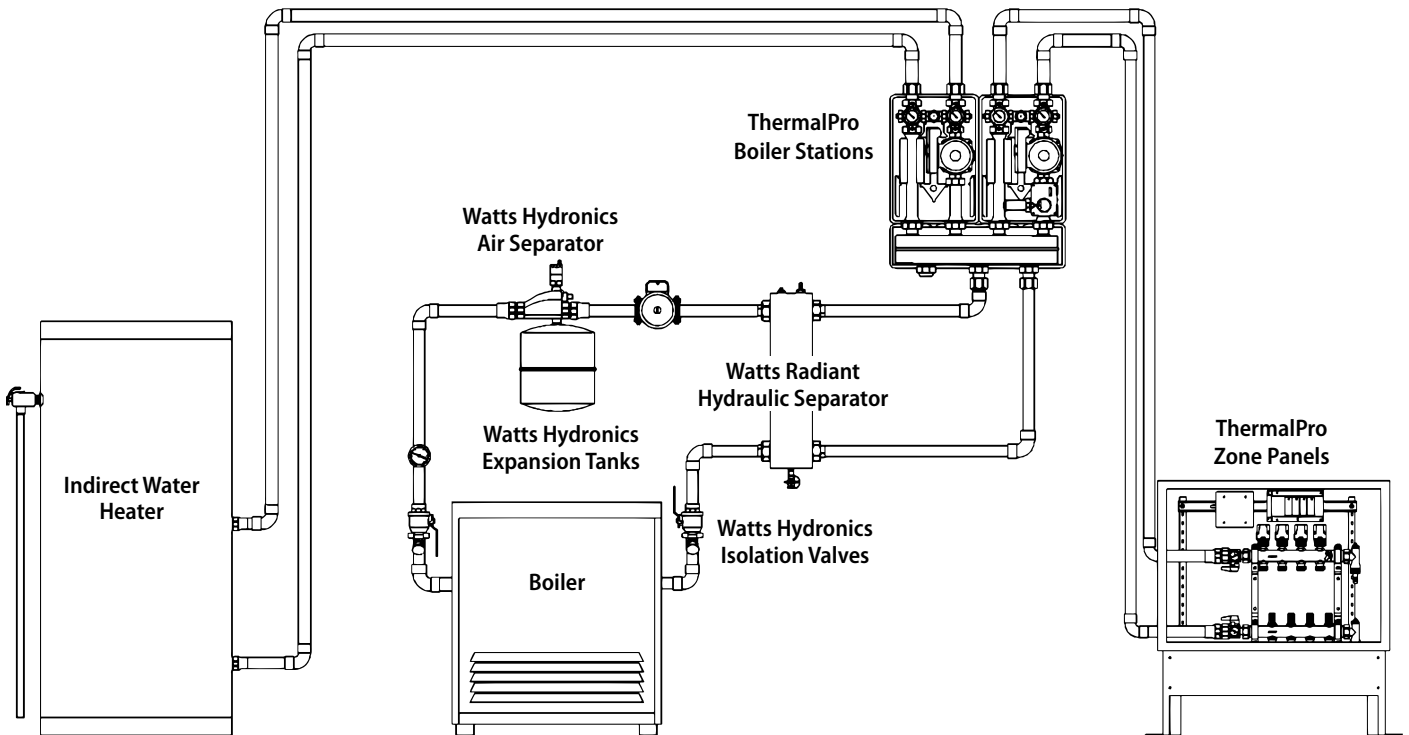

ThermalPro™ Standard Basic (with or without actuators)

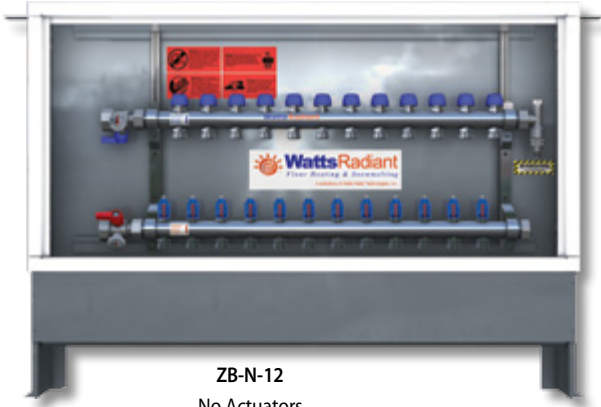

ZB-N-12
No Actuators

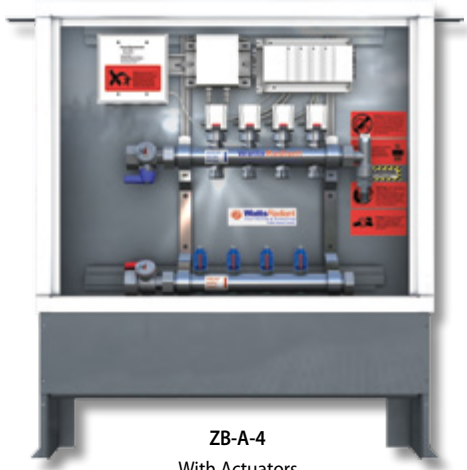

ZB-A-4
With Actuators

Use this model number configuration to order.

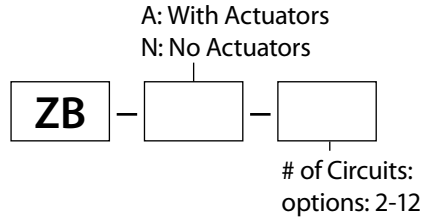

Zone Basic

DESCRIPTION	MODEL #	WT. (lbs)	SIZE
2 Circuit	ZB - ____ - ____	30-40	M
3 Circuit		30-40	
4 Circuit		30-40	
5 Circuit		50-65	L
6 Circuit		50-65	
7 Circuit		50-65	
8 Circuit		50-65	
9 Circuit		50-65	
10 Circuit		50-65	
11 Circuit		50-65	
12 Circuit		50-65	

M = 29.25" high x 25.5" wide x 4.5" deep
L = 29.25" high x 41.5" wide x 4.5" deep

ThermalPro Standard Basic zone panels (with or without actuators)

ThermalPro Standard Basic zone panels with pre-wired actuators and actuator control are our most popular panel. With a professional appearance, multiple radiant tube options and the wiring already done, it's easy to see why.

This panel includes a 1" stainless steel manifold housed in a powder-coated steel enclosure with a latching door. The panel includes manifold isolation valves with temperature gauges and a vent/purge assembly. The enclosure is designed to be recessed in the wall.

Maximum flow rate for entire manifold is 12 gpm. Individual circuit flow meters are 0-2 gpm.

Panels with actuators may require an optional pressure differential by-pass valve (ordered separately). If the by-pass valve is used, the maximum manifold size in a box is reduced by 2 circuits, and the maximum manifold is an M-10.

ThermalPro Standard Pump (with or without actuators)

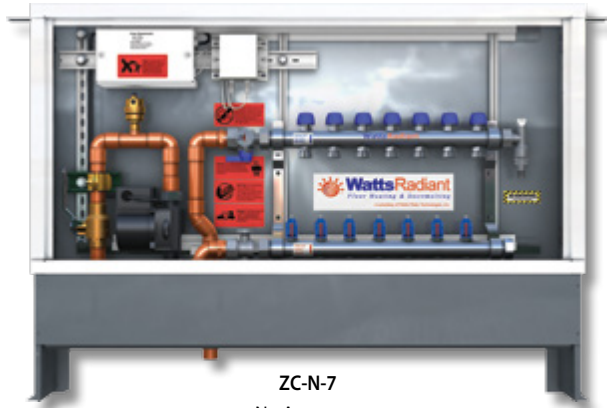

ZC-N-7
No Actuators

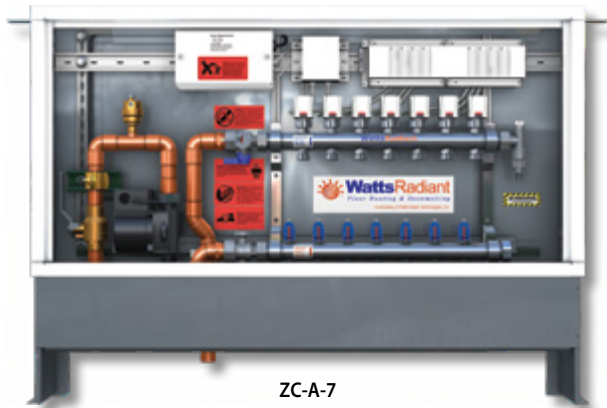

ZC-A-7
With Actuators

Use this model number configuration to order.

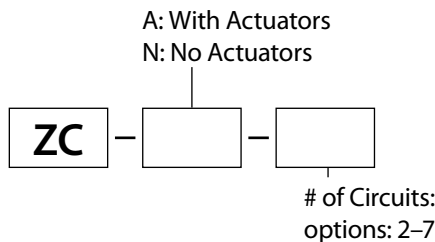

ZONE with Zone Circulator

DESCRIPTION	MODEL #	WT. (lbs)	SIZE
2 Circuit	ZC - ____ - ____	65-70	L
3 Circuit		65-70	
4 Circuit		65-70	
5 Circuit		70-75	
6 Circuit		70-75	
7 Circuit		70-75	

L = 29.25" high x 41.5" wide x 4.5" deep

ThermalPro Standard Pump Panels (with or w/o actuators)

The ThermalPro Standard Pump panel adds a Watts Radiant 1558 circulator to a ThermalPro Standard Basic Panel. It is used when the radiant manifold does not have a dedicated circulator in the mechanical room (to save space, for example).

This ThermalPro Standard panel includes a pre-wired Watts Radiant 1558 circulator, and a 1" stainless steel manifold housed in a powder-coated steel enclosure with a latching door. The panel includes manifold isolation valves with temperature gauges and a vent/purge assembly. The enclosure is designed to be recessed in the wall. The single speed 1558 circulator produces approximately 10 gpm at 10 ft hd.

Maximum flow rate for entire panel is approximately 8 gpm. Individual circuit flow meters are 0-2 gpm.

Panels with actuators may require an optional pressure differential by-pass valve (ordered separately). If the by-pass valve is used, the maximum manifold size allowed is an M-5.

ThermalPro Standard Mix Pump (with or without actuators)

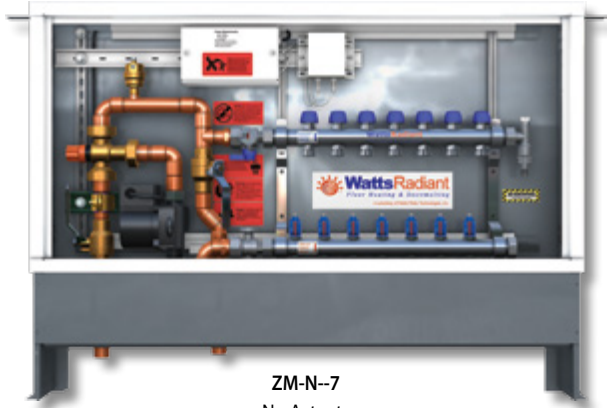

ZM-N-7
No Actuators

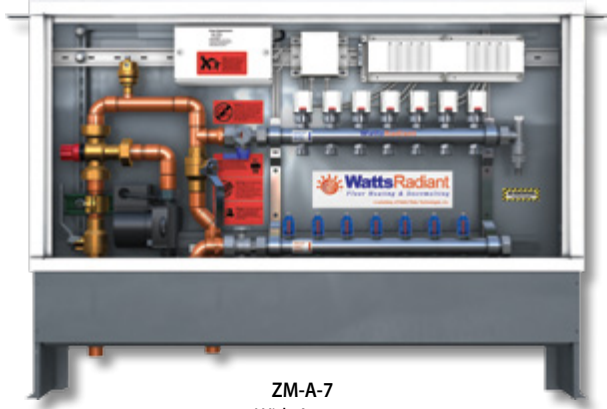

ZM-A-7
With Actuators

Use this model number configuration to order.

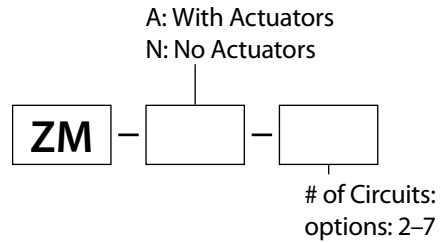

ZONE with Mix Valve & Zone Circulator

DESCRIPTION	MODEL #	WT. (lbs)	SIZE
2 Circuit	ZM - ____ - ____	70-75	L
3 Circuit		70-75	
4 Circuit		70-75	
5 Circuit		75-80	
6 Circuit		75-80	
7 Circuit		75-80	

L = 29.25" high x 41.5" wide x 4.5" deep

ThermalPro Standard Mix Pump Panels (with or w/o actuators)

The ThermalPro Standard Mix Pump panel adds fixed temperature mixing capability to the ThermalPro Standard Pump Panel. It includes a 3 way mixing valve (max flow rate approximately 3.5 gpm) a pre-wired Watts Radiant 1558 circulator, and a 1" stainless steel manifold housed in a powder-coated steel enclosure with a latching door. The panel includes manifold isolation valves with temperature gauges and a vent/purge assembly. The enclosure is designed to be recessed in the wall. The single speed 1558 circulator produces approximately 10 gpm at 10 ft hd.

Maximum flow rate for entire panel is approximately 4 gpm. Individual circuit flow meters are 0-2 gpm.

Panels with actuators may require an optional pressure differential by-pass valve (ordered separately). If the by-pass valve is used, the maximum manifold size allowed is an M-5.

ThermalPro™ Non-Mixing Station No Pump

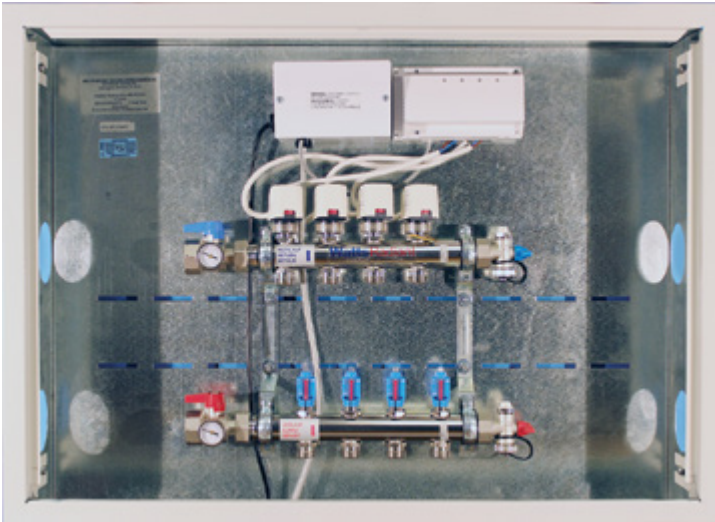

The ThermalPro Non-Mixing Manifold Station consists of either a Watts Radiant 1" Standard or HiFlow Stainless Steel manifold installed in a beautiful white powder coated steel cabinet with cover door. Manifold Stations are available in 2 to 12 loop manifold configurations. The Manifold Station can be provided with manifold loop actuating motors and a Watts Radiant Zone Control Module installed in the cabinet to simplify system zone wiring.

ThermalPRO™ Manifold Station Model Number

Station Type	Pump Model	Actuator Option	Manifold	Loops
NOM	0			
No Mixing	0 - No Pump	A - with Actuators B - less Actuators	ST - 1" Standard HF - High Flow	02 through 12

Manifold Size	Cabinet Dimensions	Rough-In Dimensions
2 to 6 Loop	33" W x 26"H x 5-3/4"D	31" W x 24"H x 5-3/4"D
7 to 12 Loop	42" W x 26"H x 5-3/4"D	40" W x 24"H x 5-3/4"D

Some items may be special order

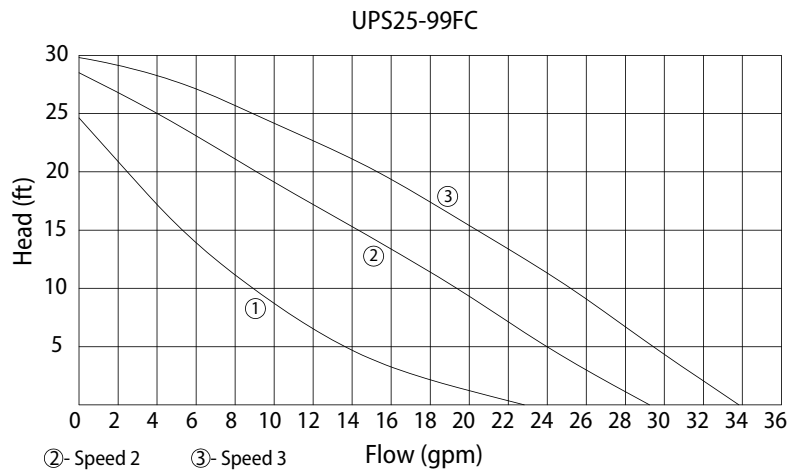
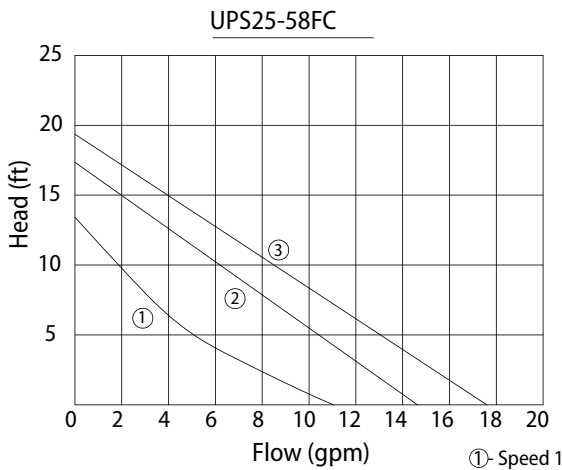

ThermalPro™ Non-Mixing Station With Pump



The ThermalPro Non-Mixing Manifold Station consists of either a Watts Radiant 1" Standard or HiFlow Stainless Steel manifold installed in a beautiful white powder coated steel cabinet with cover door. Manifold Stations are available in 2 to 12 loop manifold configurations. The Manifold Station can be provided with manifold loop actuating motors and a Watts Radiant Zone Control Module installed in the cabinet to simplify system zone wiring. Unit also comes with your choice of a Grundfos UPS25-58FC or UPS25-99FC multi-speed circulator.

ThermalPRO™ Manifold Station Model Number

Station Type	Pump Model	Actuator Option	Manifold	Loops
NOM				
No Mixing	1-UPS25-88 2-UPS25-99	A – with Actuators B – less Actuators	ST – 1" Standard HF – High Flow	02 through 12

Manifold Size	Cabinet Dimensions	Rough-In Dimensions
2 to 6 Loop	33" W x 26"H x 5-3/4"D	31" W x 24"H x 5-3/4"D
7 to 10 Loop	42" W x 26"H x 5-3/4"D	40" W x 24"H x 5-3/4"D
11 to 12 Loop	52" W x 26"H x 5-3/4"D	50" W x 24"H x 5-3/4"D

Some items may be special order

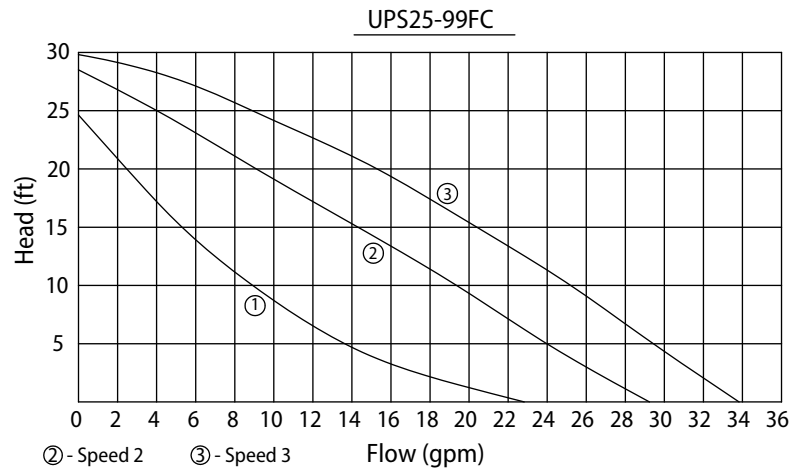
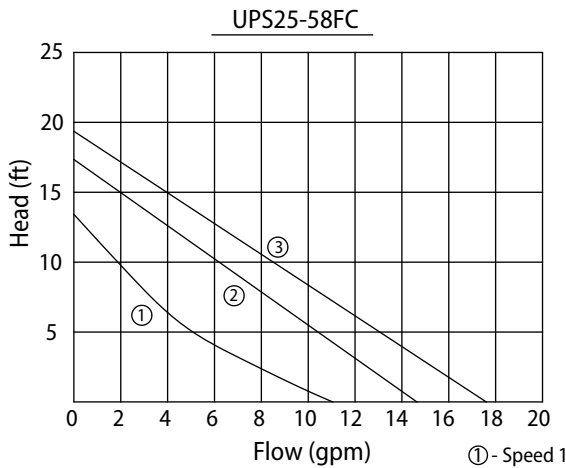

ThermalPro™ Isotherm Mixing Station

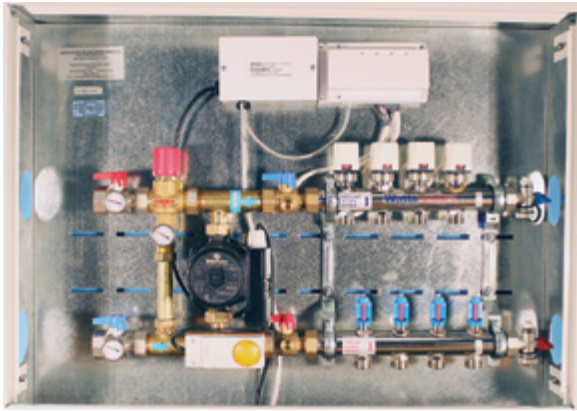

The ThermalPro Isotherm Mixing Module is a compact, pre-piped, pre-wired pump and mixing valve control connected directly to a Watts Radiant 1" Stainless Steel manifold and installed in a beautiful white powder coated steel cabinet with cover door.

The ThermalPro Isotherm Mixing Module speeds up radiant installations by providing a complete piping and mixing system in a box that's ready to go. The Isotherm Mixing Module can provide up to 50,000 Btu/h for a standard radiant heating system. The temperature range of the Isotherm mixing module's adjustable and lockable mixing valve is 110°F to 140°F providing a wide range of control to accommodate many project design applications.

The Manifold Station can be provided with manifold loop actuating motors and a Watts Radiant Zone Control Module installed in the cabinet to simplify system zone wiring.

ThermalPRO™ Manifold Station Model Number

Station Type	Pump Model	Actuator Option	Manifold	Loops
ISO	1		ST	
Isotherm Mixing Module	1-UPS25-88	A – with Actuators B – less Actuators	ST – 1" Standard	02 through 12

Manifold Size	Cabinet Dimensions	Rough-In Dimensions
2 to 6 Loop	33" W x 26"H x 5-3/4"D	31" W x 24"H x 5-3/4"D
7 to 12 Loop	42" W x 26"H x 5-3/4"D	40" W x 24"H x 5-3/4"D

Some items may be special order

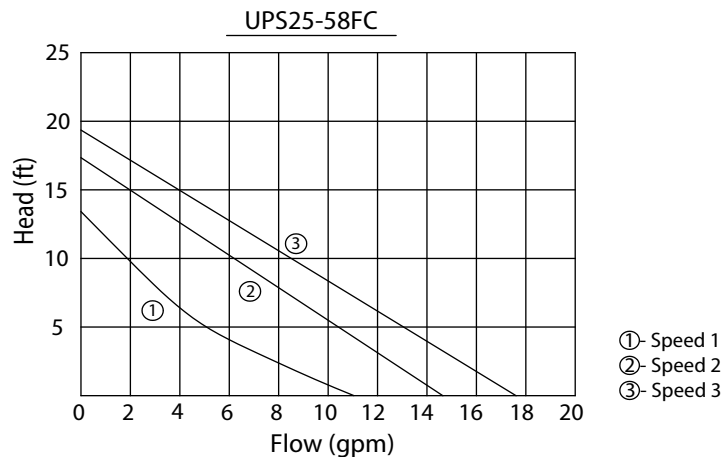

ThermalPro™ Mixing Station

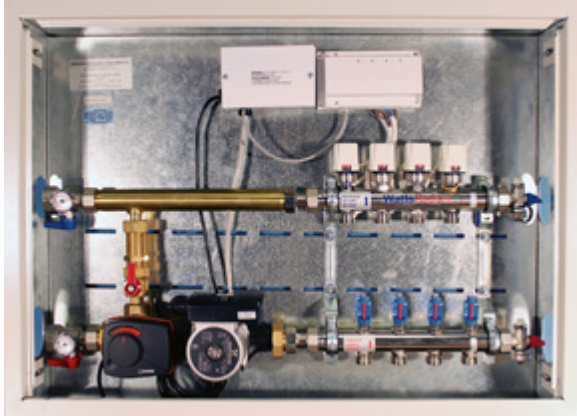

The ThermalPro Isotherm Mixing Module is a compact, pre-piped, pre-wired pump and mixing valve control connected directly to a Watts Radiant 1" Standard or 1-1/2 Hi-Flow Stainless Steel manifold and installed in a white powder coated steel cabinet with cover door. ThermalPro Mixing Modules are supplied with your choice of either an UPS25-58 or UPS26-99 circulator depending on your projects flow and/or head requirements. The unit also comes equipped with a 3-way 24V motorized mixing valve, **the controller is sold separately.**

The Manifold Station can be provided with manifold loop actuating motors and a Watts Radiant Zone Control Module, as an option, installed in the cabinet to simply system zone wiring.

ThermalPRO™ Manifold Station Model Number

Station Type	Pump Model	Actuator Option	Manifold	Loops
3WM				
3-Way 24V Mixing Valve	1-UPS25-88 2-UPS26-99	A – with Actuators B – less Actuators	ST – 1" Standard HF – High Flow	02 through 12

Manifold Size	Cabinet Dimensions	Rough-In Dimensions
2 to 6 Loop	33" W x 26"H x 5-3/4"D	31" W x 24"H x 5-3/4"D
7 to 10 Loop	42" W x 26"H x 5-3/4"D	40" W x 24"H x 5-3/4"D
11 to 12 Loop	52" W x 26"H x 5-3/4"D	50" W x 24"H x 5-3/4"D

Some items may be special order

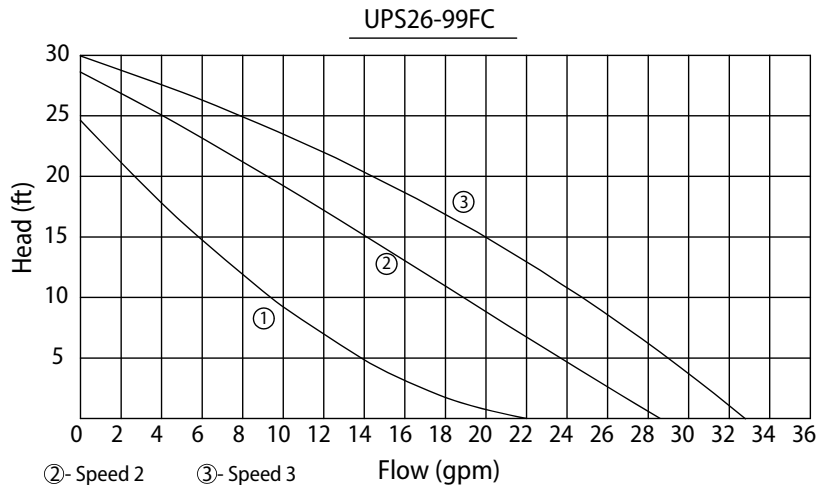
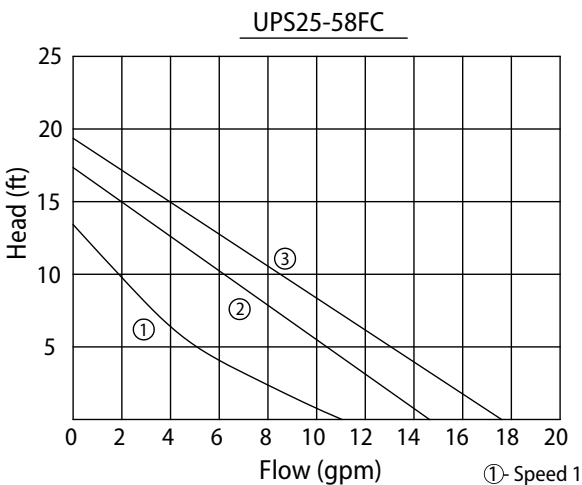



Custom HydroControl® and HydroSkid™ Mechanical Packages

Our custom mechanical packages help ensure fast, efficient, trouble-free installations in any application. Watts Radiant has been designing and building custom mechanical panels for over 25 years. We supply OEM mechanical components to many major hydronic manufacturers as well as independent contractor and mechanical installers. Put our experience to work for you.

Custom HydroControl and HydroSkid mechanical packages are manufactured exactly to your project specifications, with capabilities up to 6 inch copper. Each package is fully tested, factory warranted, and ready for installation.

HydroControls and HydroSkids feature professional-grade components from companies you trust- Watts®, Bell and Gossett, Taco®, and tekmar® to name a few. Our expertise in manufacturing and our selection of quality components ensure trouble-free operation and longevity.

Send us your project specifications and/or a RadiantWorks mechanical summary and we'll prepare a quote.

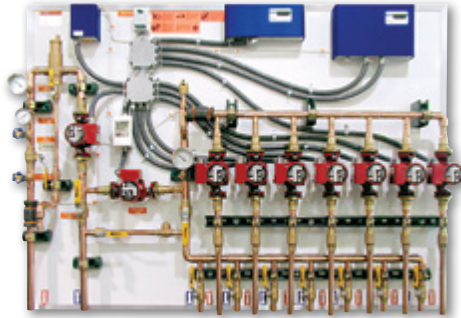

Versatile Custom Panels fill a variety of needs

Watts Radiant custom HydroControl panels fill the mechanical needs of any radiant, snow melting, turf warming, or permafrost project. From small residences to commercial spaces to industrial facilities, we have the capability to engineer the perfect solution.

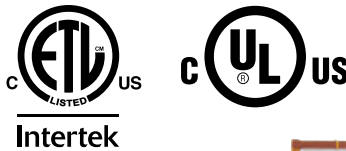

Intertek

Custom HydroSkids™ for Commercial and Industrial Radiant Heating or Snow Melting

Offer your commercial and industrial clients the comfort and energy saving benefits of radiant floor warming or the protection and convenience of a snow melting system. Let the design team at Watts Radiant work with you to design customized system solutions for radiant heating, snow melting, or permafrost protection.

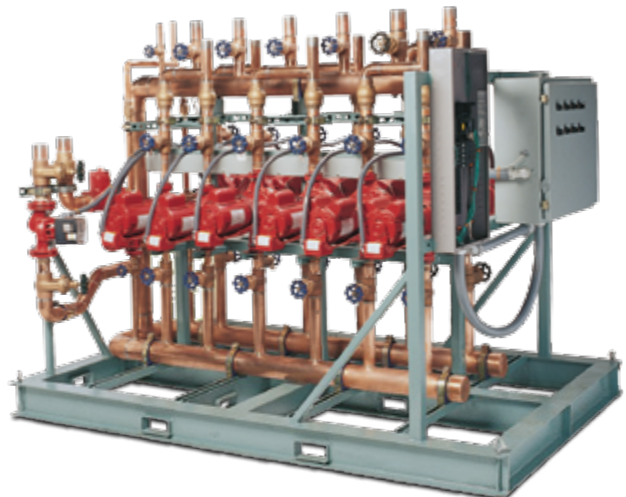
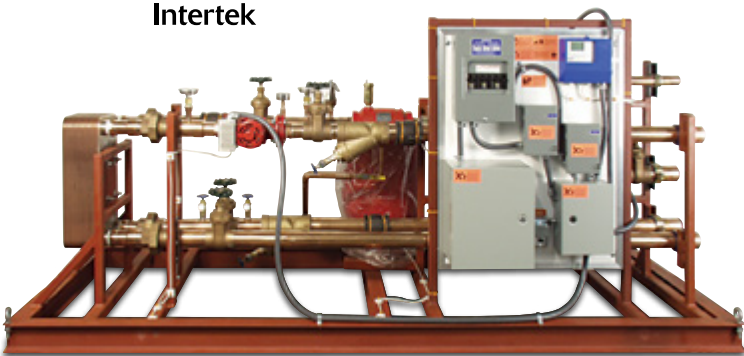

Easy-to-Install Electric Radiant Solutions

Electric Floor Heating



**TapeMat[®], Custom TapeMat[®]
& ShowerMat[™]**

- Open-weave mesh for one-step mortar installation



WarmWire[®]

- Flexible layout for rooms of all shapes & sizes



UnderFloor[™] Mat

- Installs between floor joists to warm the floor above



SlabHeat[®]

- In-slab installation with capacity for space heating



**HeatMatrix[™] Uncoupling
Membrane**

- Simplify WarmWire installation, protect tile and stone flooring



**SunStat[®] Thermostats,
Relays & Accessories**

- Controls and accessories to complete your installation



Electric Snow Melting



ProMelt[®] Mats

- 2' or 3' wide rolls with 120, 208 & 240 VAC models

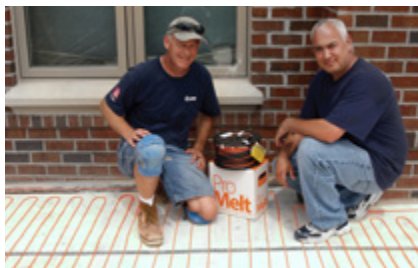

ProMelt[®] Cable

- Complete flexibility to match stairs & curves



**ProMelt[®] Controls
& Accessories**

- All-in-one or contactor & control combinations

TapeMat®, Custom TapeMat and ShowerMat™

- Order Custom TapeMat to match your floor plan or select a standard TapeMat roll size
- ShowerMat is sized to fit standard shower base sizes and includes an opening for the drain
- All offer 1-step application with thinset or self-leveler
- Open-weave mesh allows mortar to easily bond with underlying material
- 1/8" thickness added to a typical tile installation
- Simple to adjust for curves, angles, & cutouts
- Double-sided tape adheres to subfloor for faster layouts
- UL listed at 12 watts/square foot
- Operated by any SunStat thermostat
- 25-year limited warranty



Selecting a standard TapeMat roll size:

- Calculate the total wall-to-wall square footage of the room.
- Subtract the square footage of all built-ins (closets, tub, toilet, cabinets).
- Multiply the result by .9 and round down to the nearest 5 ft².
- Select TapeMat to match roll width, voltage & square footage.

TapeMat is available in 2' & 3' roll widths with 120 VAC or 240 VAC power.

120 VAC TapeMat

	Size (L x W)	Ft ²	Order#	Model#	Amps
2' Wide	5' x 2'	10	81002183	12000524ST	1.0
	7' 6" x 2'	15	81007233	12000724ST	1.5
	10' x 2'	20	81002197	12001024ST	2.0
	12' 6" x 2'	25	81007234	12001224ST	2.5
	15' x 2'	30	81002208	12001524ST	3.0
	17' 6" x 2'	35	81007235	12001724ST	3.5
	20' x 2'	40	81002217	12002024ST	4.0
	22' 6" x 2'	45	81007236	12002224ST	4.5
	25' x 2'	50	81002226	12002524ST	5.0
	30' x 2'	60	81002234	12003024ST	6.0
3' Wide	35' x 2'	70	81002240	12003524ST	7.0
	40' x 2'	80	81002246	12004024ST	8.0
	5' x 3'	15	81002184	12000536ST	1.5
	6' 9" x 3'	20	81002188	12000636ST	2.0
	8' 3" x 3'	25	81002194	12000836ST	2.5
	10' x 3'	30	81002200	12001036ST	3.0
15' x 3'	45	81002209	12001536ST	4.5	
20' x 3'	60	81002220	12002036ST	6.0	

240 VAC TapeMat

	Mat Size (L x W)	Ft ²	Order#	Model#	Amps
2' Wide	10' x 2'	20	81002265	24001024ST	1.0
	15' x 2'	30	81002269	24001524ST	1.5
	20' x 2'	40	81002274	24002024ST	2.0
	25' x 2'	50	81002279	24002524ST	2.5
	30' x 2'	60	81002284	24003024ST	3.0
	35' x 2'	70	81002288	24003524ST	3.5
	40' x 2'	80	81002293	24004024ST	4.0
	45' x 2'	90	81002407	24004524ST	4.5
	50' x 2'	100	81002410	24005024ST	5.0
	60' x 2'	120	81002415	24006024ST	6.0
3' Wide	70' x 2'	140	81002419	24007024ST	7.0
	80' x 2'	160	81002422	24008024ST	8.0
	10' x 3'	30	81002266	24001036ST	1.5
	13' 3" x 3'	40	81002268	24001336ST	2.0
	16' 9" x 3'	50	81002272	24001636ST	2.5
	20' x 3'	60	81002277	24002036ST	3.0
30' x 3'	90	81002286	24003036ST	4.5	
40' x 3'	120	81002406	24004036ST	6.0	

How to Order Custom TapeMat

1. Send a complete drawing to designs@wattswater.com or call our design team toll-free at 1-888-432-8932 for assistance
2. Drawing must include the following:
 - Complete, accurate dimensions of the area to be heated. Include all wall dimensions from start to finish around the perimeter of the room
 - Thermostat location
 - Dimensions & locations of any obstructions in the heated area (vents, plumbing, cabinets, steps, etc.)
3. A design showing the Custom TapeMat layout will be faxed back for customer approval
4. Once the design is approved, please send a purchase order, including:
 - Custom TapeMat order number
 - Custom TapeMat project number
 - Customer's approved signature on the design drawing
5. Mats will ship within 7-10 days of receipt of purchase order with the customer-approved, signed drawing

120 VAC Custom TapeMat

Ft ²	Order #	Model #	Amps
10	81016649	C12120010ST	1.0
15	81016650	C12120015ST	1.5
20	81016651	C12120020ST	2.0
25	81016652	C12120025ST	2.5
30	81016653	C12120030ST	3.0
35	81016654	C12120035ST	3.5
40	81016590	C12120040ST	4.0
45	81016655	C12120045ST	4.5
50	81016656	C12120050ST	5.0
60	81016565	C12120060ST	6.0
70	81016657	C12120070ST	7.0
80	81016658	C12120080ST	8.0

240 VAC Custom TapeMat

Ft ²	Order #	Model #	Amps
20	81016659	C12240020ST	1.0
30	81016660	C12240030ST	1.5
40	81016661	C12240040ST	2.0
50	81016662	C12240050ST	2.5
60	81016663	C12240060ST	3.0
70	81016664	C12240070ST	3.5
80	81016665	C12240080ST	4.0
90	81016666	C12240090ST	4.5
100	81016667	C12240100ST	5.0
120	81016668	C12240120ST	6.0
140	81016669	C12240140ST	7.0
160	81016670	C12240160ST	8.0

ShowerMat™

Tile and stone feel warm and soothing when installed over an operating ShowerMat. With this simple addition, you can improve comfort and floor surface drying times. ShowerMats are installed in thinset mortar above the shower pan liner. They can be individually controlled or operated by the same control as other floor heated areas of the bathroom. ShowerMats make it easy to install a separate heating system in the shower.

120 VAC ShowerMat

Shower base size	Actual mat size	Order#	Model#	Amps
36" x 60"	28" x 52"	81018140	C12120010HW-S3660	1.0
48" x 48"	39" x 39"	81018141	C12120010HW-S4848	1.0

Other sizes are available by special order.

- Secure to liner with glue gun or double-sided tape
- 4" center drain cut-out
- 10' power lead for installation outside of the shower

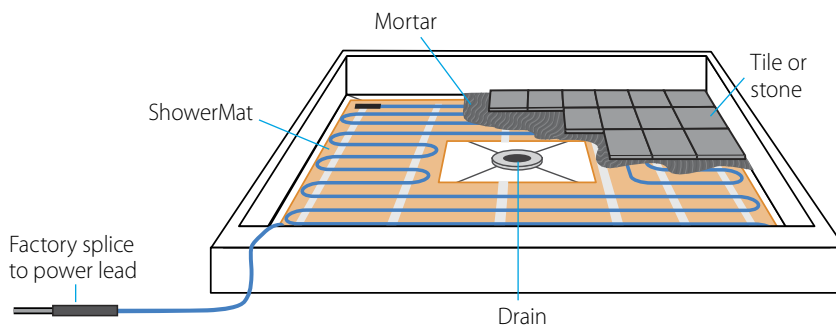

TapeMat® Kits

TapeMat® Kits include everything needed for a quick & simple floor warming installation.

TapeMat Kits Include:

- 2' wide TapeMat
- SunStat® Command Thermostat
- Extra Double-sided Tape
- LoudMouth™ Installation Monitor
- Installation Manual

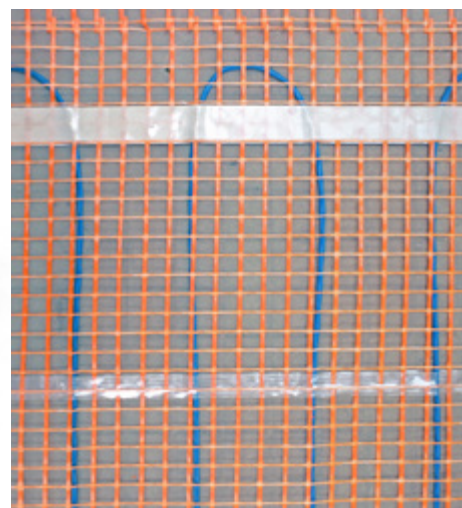

TapeMat Kits are available for a full range of room sizes.

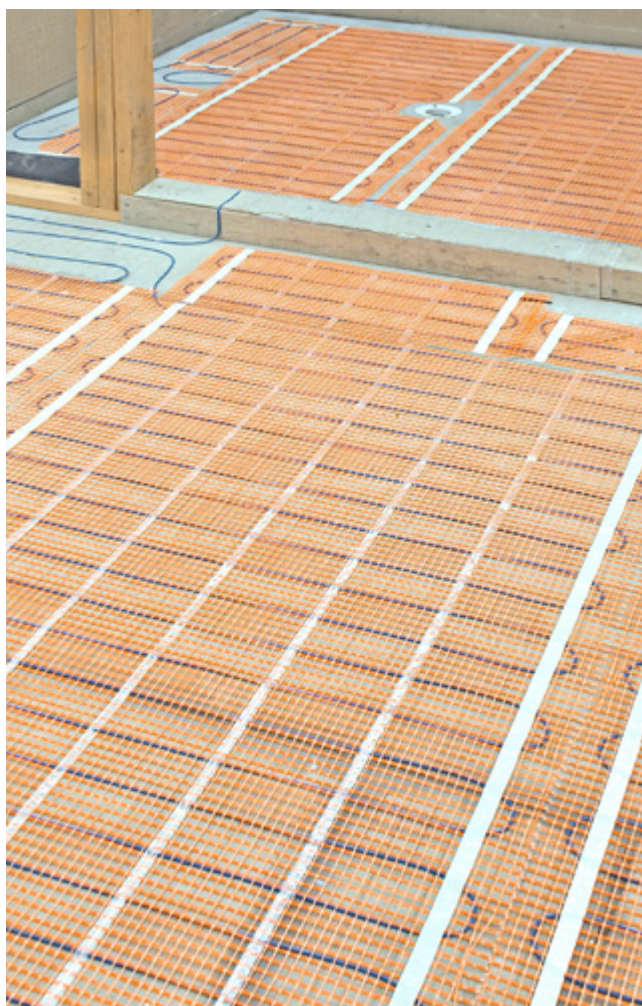

120 VAC TapeMat Kits

Ft²	Quantity & Size of Mats	Order#	Model#	Amps
10	(1) 2' x 5'	81009684	12000524-KIT	1.0
15	(1) 2' x 7.5'	81009685	12000724-KIT	1.5
20	(1) 2' x 10'	81009686	12001024-KIT	2.0
25	(1) 2' x 12.5'	81009687	12001224-KIT	2.5
30	(1) 2' x 15'	81009688	12001524-KIT	3.0
35	(1) 2' x 17.5'	81009689	12001724-KIT	3.5
40	(1) 2' x 20'	81009690	12002024-KIT	4.0
45	(1) 2' x 22.5'	81009691	12002224-KIT	4.5
50	(1) 2' x 25'	81009692	12002524-KIT	5.0
60	(1) 2' x 30'	81009693	12003024-KIT	6.0
70	(1) 2' x 35'	81009694	12003524-KIT	7.0
80	(1) 2' x 40'	81009695	12004024-KIT	8.0
90	(1) 2' x 45'	81010512	12004524-KIT	9.0
100	(1) 2' x 50'	81010513	12005024-KIT	10.0
110	(1) 2' x 25' & (1) 2' x 30'	81010514	12005524-KIT	11.0
120	(2) 2' x 30'	81010515	12006024-KIT	12.0
130	(1) 2' x 30' & (1) 2' x 35'	81010516	12006524-KIT	13.0
140	(2) 2' x 35'	81010517	12007024-KIT	14.0
150	(1) 2' x 35' & (1) 2' x 40'	81010518	12007524-KIT	15.0

WarmWire®



WarmWire installed using HeatMatrix



WarmWire installed using CableStrap

- Wire is easily secured with CableStrap™ or HeatMatrix™ uncoupling membrane
- Wire spacing can be adjusted to match rooms with different heating needs.
- Approved for shower installation where permitted by the local authority having jurisdiction (AHJ)
- New improved wire allows for increased jobsite toughness and durability
- Constant diameter wire makes installation with HeatMatrix quick and easy
- 25-year warranty



WarmWire® Spools

WarmWire coverage depends on the selected wire spacing.

- 2.5" spacing is recommended for high heat loss areas like sunrooms or basement rec rooms.
- 3" spacing is recommended for kitchens, bathrooms, and living rooms over wood-framed subfloors.
- 3.5" spacing may be used in lower heat loss areas such as hallways.

120 VAC WarmWire

Heated Area (ft ²)			Order#	Model#	Length	Amps
2.5" o.c. (14.4 W/ft ²)	3" o.c. (12 W/ft ²)	3.5" o.c. (10.3 W/ft ²)				
8	10	12	81019558	120010WB-CST	39'	1.0
13	15	18	81019559	120015WB-CST	59'	1.5
17	20	24	81019560	120020WB-CST	78'	2.0
21	25	30	81019561	120025WB-CST	98'	2.5
25	30	36	81019562	120030WB-CST	117'	3.0
29	35	42	81019563	120035WB-CST	137'	3.5
34	40	48	81019564	120040WB-CST	157'	4.0
38	45	54	81019565	120045WB-CST	176'	4.5
42	50	60	81019566	120050WB-CST	196'	5.0
51	60	72	81019567	120060WB-CST	235'	6.0
59	70	84	81019568	120070WB-CST	274'	7.0
67	80	96	81019569	120080WB-CST	313'	8.0
76	90	108	81019570	120090WB-CST	352'	9.0
84	100	120	81019571	120100WB-CST	391'	10.0

Standard spacing

240 VAC WarmWire

Heated Area (ft ²)			Order#	Model#	Length	Amps
2.5" o.c. (14.4 W/ft ²)	3" o.c. (12 W/ft ²)	3.5" o.c. (10.3 W/ft ²)				
17	20	24	81019572	240020WB-CST	78'	1.0
25	30	36	81019573	240030WB-CST	117'	1.5
34	40	48	81019574	240040WB-CST	157'	2.0
42	50	60	81019575	240050WB-CST	196'	2.5
51	60	72	81019576	240060WB-CST	235'	3.0
59	70	84	81019577	240070WB-CST	274'	3.5
67	80	96	81019578	240080WB-CST	313'	4.0
76	90	108	81019579	240090WB-CST	352'	4.5
84	100	120	81019580	240100WB-CST	391'	5.0
101	120	144	81019581	240120WB-CST	470'	6.0
118	140	168	81019582	240140WB-CST	548'	7.0
135	160	192	81019583	240160WB-CST	626'	8.0
151	180	216	81019584	240180WB-CST	704'	9.0
168	200	240	81019585	240200WB-CST	783'	10.0

Standard spacing

WarmWire® Kits

WarmWire® Kits make it easy to select products to match your installation.

WarmWire Kits include:

- WarmWire Cable(s)
- SunStat® Command Thermostat
- CableStrap™
- LoudMouth® Installation Monitor
- Double-sided Tape
- Installation Manual



*WarmWire Kits larger than 300 ft² include a SunStat Relay C3, as well as a SunStat Command thermostat. These sizes are not packaged in full color boxes.

120 VAC WarmWire Kits

Heated Area (ft ²)			Qty & Size of Cables	Order#	Model#	Amps
2.5" o.c. (14.4 W/ft ²)	3" o.c. (12 W/ft ²)	3.5" o.c. (10.3 W/ft ²)				
8	10	12	(1) 10 ft ²	81018089	120010WD-BKIT	1.0
13	15	18	(1) 15 ft ²	81018090	120015WD-BKIT	1.5
17	20	24	(1) 20 ft ²	81018091	120020WD-BKIT	2.0
21	25	30	(1) 25 ft ²	81018092	120025WD-BKIT	2.5
25	30	36	(1) 30 ft ²	81018093	120030WD-BKIT	3.0
29	35	42	(1) 35 ft ²	81018094	120035WD-BKIT	3.5
34	40	48	(1) 40 ft ²	81018095	120040WD-BKIT	4.0
38	45	54	(1) 45 ft ²	81018096	120045WD-BKIT	4.5
42	50	60	(1) 50 ft ²	81018097	120050WD-BKIT	5.0
51	60	72	(1) 60 ft ²	81018098	120060WD-BKIT	6.0
59	70	84	(1) 70 ft ²	81018099	120070WD-BKIT	7.0
67	80	96	(1) 80 ft ²	81018100	120080WD-BKIT	8.0
76	90	108	(1) 90 ft ²	81018101	120090WD-BKIT	9.0
84	100	120	(1) 100 ft ²	81018102	1200100WD-BKIT	10.0
93	110	132	(1) 50 + (1) 60 ft ²	81018103	1200110WD-BKIT	11.0
102	120	144	(2) 60 ft ²	81018104	1200120WD-BKIT	12.0
110	130	156	(1) 60 + (1) 70 ft ²	81018105	1200130WD-BKIT	13.0
118	140	168	(2) 70 ft ²	81018106	1200140WD-BKIT	14.0
126	150	180	(1) 70 + (1) 80 ft ²	81018107	1200150WD-BKIT	15.0

Standard spacing

240 VAC WarmWire Kits

Heated Area (ft ²)			Qty & Size of Cables	Order#	Model#	Amps
2.5" o.c. (14.4 W/ft ²)	3" o.c. (12 W/ft ²)	3.5" o.c. (10.3 W/ft ²)				
135	160	192	(1) 160 ft ²	81018114	240160WD-BKIT	8.0
143	170	204	(1) 80 + (1) 90 ft ²	81018115	240170WD-BKIT	8.5
152	180	216	(2) 90 ft ²	81018116	240180WD-BKIT	9.0
160	190	228	(1) 90 + (1) 100 ft ²	81018117	240190WD-BKIT	9.5
168	200	240	(2) 100 ft ²	81018118	240200WD-BKIT	10.0
185	220	264	(1) 100 + (1) 120 ft ²	81018119	240220WD-BKIT	11.0
202	240	288	(2) 120 ft ²	81018120	240240WD-BKIT	12.0
219	260	312	(1) 120 + (1) 140 ft ²	81018121	240260WD-BKIT	13.0
236	280	336	(2) 140 ft ²	81018122	240280WD-BKIT	14.0
253	300	360	(1) 140 + (1) 160 ft ²	81018123	240300WD-BKIT	15.0
286	340	408	(1) 160 + (1) 180 ft ²	*81018125	240340WD-BKIT	17.0
320	380	456	(2) 120 + (1) 140 ft ²	*81018127	240380WD-BKIT	19.0
354	420	504	(3) 140 ft ²	*81018129	240420WD-BKIT	21.0
388	460	552	(1) 140 + (2) 160 ft ²	*81018131	240460WD-BKIT	23.0
421	500	600	(3) 120 + (1) 140 ft ²	*81018133	240500WD-BKIT	25.0

Standard spacing

NEW HeatMatrix™ Uncoupling Membrane

- Simply press WarmWire® into the HeatMatrix channels at the selected spacing
- Protect tile and stone from cracking with a sheer stress control layer that isolates the surface from subfloor movement
- Provide a barrier against surface water with durable polypropylene construction
- HeatMatrix is ideal for below grade installations with deep-grooved channels that allow evaporation of moisture from below the membrane

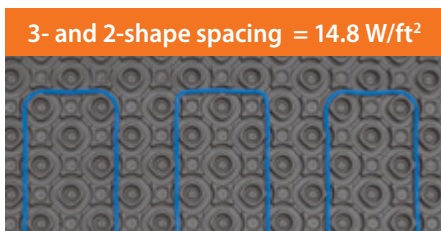

High heat loss areas like sunrooms, basements, or near windows.

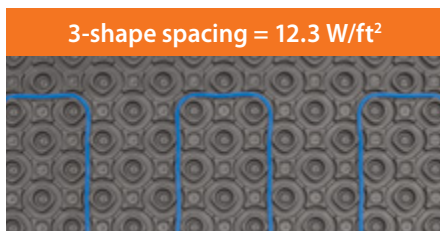

Recommended for kitchens, bathrooms, & living areas.

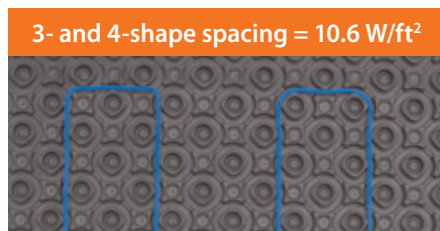

Lower heat loss areas such as hallways, 2nd floor interior spaces, or low traffic areas.

HeatMatrix™ uncoupling membrane

Protect your investment in flooring while reducing WarmWire installation time. Flexible spacing options let you adjust the heat output and easily fit WarmWire within the space.

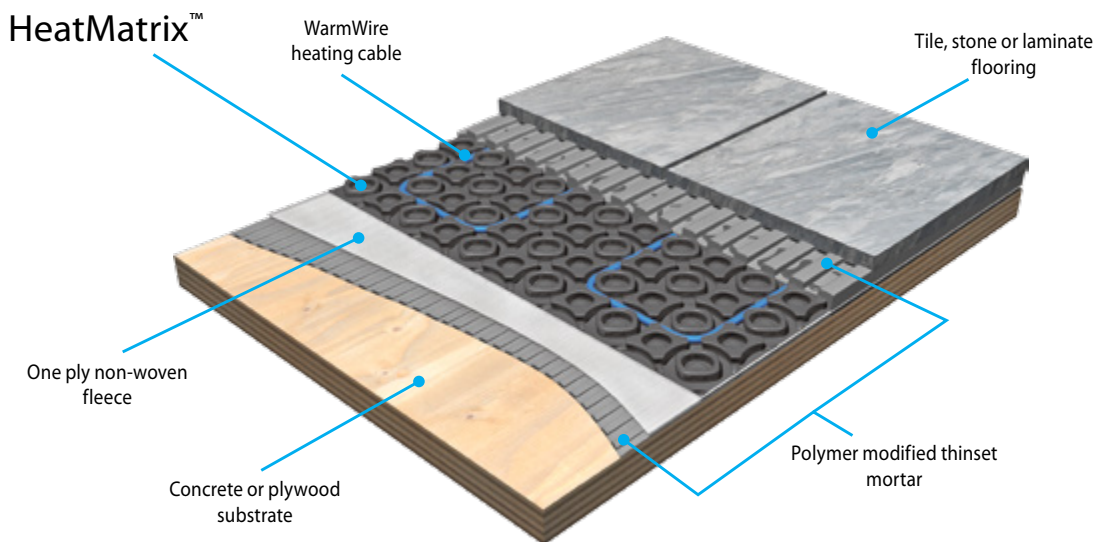

Roll selection

HeatMatrix is installed in both unheated and heated areas to provide crack-isolation, vapor management, and waterproofing. Order a quantity that will cover the full square footage of the area to be tiled.

HeatMatrix roll sizes

Coverage	L x W	Order#	Model#
161 ft²	49.2' x 3.28' (15 m x 1 m)	81019454	8006GRY161-ST
40 ft²	12.2' x 3.28' (3.71 m x 1 m)	81019455	8006GRY40-ST

For areas where the floor is exposed to surface water, HeatMatrix Joint Tape is recommended to seal the seams. Refer to the electric heating accessory pages for ordering information.

UnderFloor™ Mat

- No need to replace flooring — installs between floor joists to warm the floor above
- Works under any type of flooring including nail down hardwood
- Up to 15°F warmer with hard-surface flooring
- Between 6°F and 10°F warmer with carpet

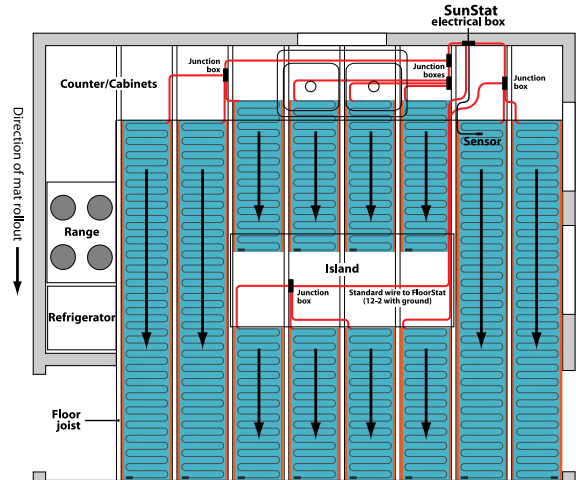

UnderFloor™ Mats

These easy-to-install mats come in two widths for common joist spacing. For the best performance, follow the installation manual recommendations for insulating between joists under the mats.

120 VAC UnderFloor Mat

	Size (L x W)	Order#	Model#	Amps
12" Wide	5' 6" x 12"	81007125	1200512U2ST	0.4
	8' x 12"	81007126	1200812U2ST	0.6
	10' 6" x 12"	81007127	1201012U2ST	0.9
	13' x 12"	81007128	1201312U2ST	1.1
	16' x 12"	81007129	1201612U2ST	1.3
16" Wide	4' x 16"	81006826	1200416U2ST	0.4
	6' x 16"	81006827	1200616U2ST	0.6
	8' x 16"	81006828	1200816U2ST	0.8
	9' 6" x 16"	81006829	1200916U2ST	1.0
	12' x 16"	81006830	1201216U2ST	1.3
	14' x 16"	81006831	1201416U2ST	1.5
	16' x 16"	81006832	1201616U2ST	1.7
	18' x 16"	81006833	1201816U2ST	1.9

240 VAC UnderFloor Mat

	Size (L x W)	Order#	Model#	Amps
12" Wide	10' 6" x 12"	81007134	2401012U2ST	0.4
	16' x 12"	81007135	2401612U2ST	0.6
16" Wide	8' x 16"	81006835	2400816U2ST	0.4
	12' x 16"	81006836	2401216U2ST	0.6
	16' x 16"	81006837	2401616U2ST	0.8
	19' 6" x 16"	81006838	2401916U2ST	1.0



SlabHeat®

- Offers enough capacity for space heating (verify heat loss calculation with our technical team)
- Installs over an existing slab in a “slab cap” or in a new slab
- Comfortable, even heat without the drying effects of forced air
- Does not promote circulation of pathogens or allergens
- Silent, maintenance-free heat with no vents or duct-work
- Engineered to handle the rigors of any concrete installation
- Polyurethane outer jacket offers superior flexibility, abrasion and tear resistance
- 10-year limited warranty

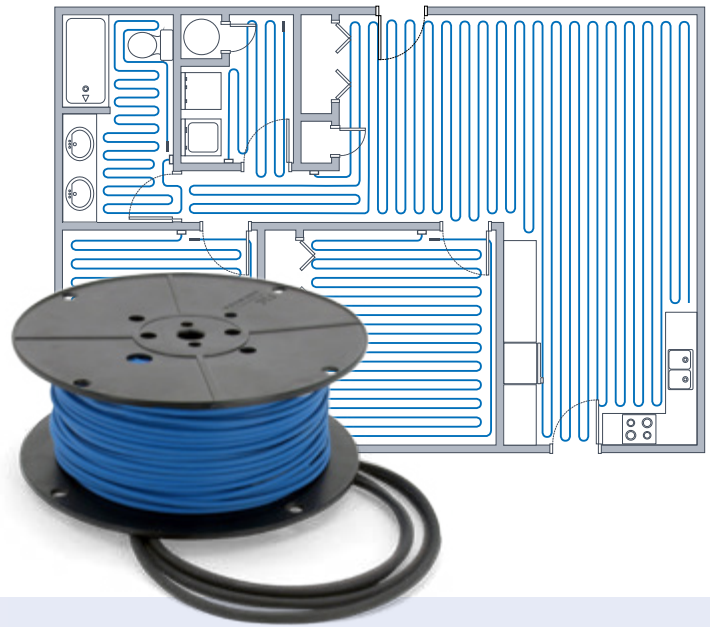

SlabHeat®

Regardless of the size, shape, or thickness of the concrete slab, SlabHeat is a simple way to provide the comfort of radiant heat. SlabHeat is engineered to produce enough Btu's to heat the slab, the space and the surface that people walk on.

- 4" on center (15 Watts/ft²) is typical for basement floor heating & high heat loss areas.
- 6" on center (10 Watts/ft²) is typical for basement floor warming & moderate heat loss areas.

Slab cap

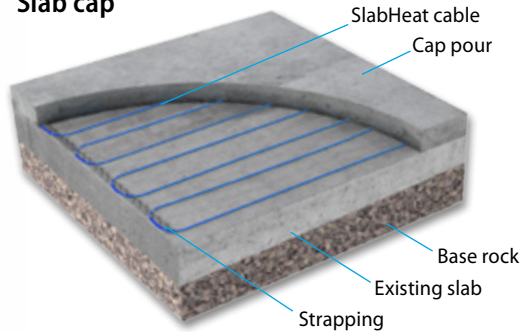

New slab

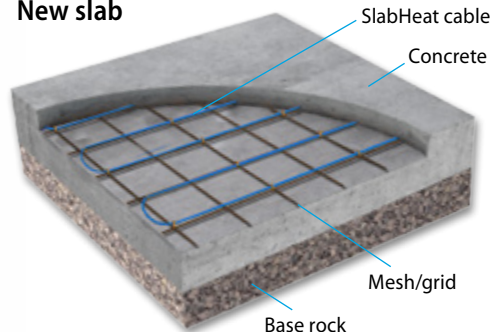

120 VAC SlabHeat

Heated Area (ft ²)		Length	Order#	Model#	Amps
4" O.C. (15 W/ft ²)	6" O.C. (10 W/ft ²)				
50	75	146'	81014956	SH15120050ST	6.3
66	98	193'	81014957	SH15120066ST	8.3
82	122	241'	81014958	SH15120082ST	10.3
100	149	294'	81014959	SH15120100ST	12.5
114	170	336'	81014960	SH15120114ST	14.3

Standard spacing

240 VAC SlabHeat

Heated Area (ft ²)		Length	Order#	Model#	Amps
4" O.C. (15 W/ft ²)	6" O.C. (10 W/ft ²)				
100	149	294'	81014961	SH15240100ST	6.3
132	196	388'	81014962	SH15240132ST	8.3
164	243	483'	81014963	SH15240164ST	10.3
200	297	590'	81014964	SH15240200ST	12.5
228	339	673'	81014965	SH15240228ST	14.3

Standard spacing

NEW SunStat® Thermostats & Relays



- Model options include energy saving schedules & touchscreens
- Can operate 120 or 240 VAC systems
- Built-in GFCI improves safety
- Air & floor temperature sensing
- Solutions for systems from 10 ft² to 3000 ft²



Get all the features you need to provide warmth when & where you want it! Simply select one thermostat for every area requiring individual control. Add SunStat Relays for areas that need more than 15 Amps of power. SunStats can be used with any of the electric floor warming systems in this brochure.



	Connect	Command	Relay C3	Core
Control one zone of heating	●	●	-	●
Dual voltage for operating 120 or 240 VAC floor heating systems	●	●	●	●
Built-in GFCI (5 milliamp trip) & 15 amp relay	●	●	●	●
15' class 2 insulated floor sensor included	●	●	-	●
Floor sensing control (*with optional air temperature override)	*●	*●	-	●
Air sensing control	●	●	-	-
Touchscreen display with multiple color themes	●	●	-	-
Adjustable brightness	●	●	-	-
Thin profile with removable, paintable beauty ring	●	●	-	-
Home automation system tie-in	●	●	-	-
Comprehensive help screens	●	●	-	-
7-day programmable schedule	●	●	-	-
Display settings in English, French or Spanish	●	●	-	-
Temporary hold setting	●	●	-	-
SmartStart technology	●	●	-	-
Away feature (Vacation mode)	●	●	-	-
Energy usage monitoring	●	●	-	-
Remote access via mobile app or web with Wi-Fi data encryption	●	-	-	-
Outdoor temperature and weather display options	●	-	-	-
Remote software upgrade capability	●	-	-	-
Weather compensation and warm weather shut down settings	●	-	-	-
Email alerts	●	-	-	-
Expand area controlled by SunStat Connect and Command thermostats	-	-	●	-
Compatible with SunStat Relay C3 (not compatible with older relays)	●	●	-	●
Order#	81019075	81019079	81019088	81019083
Model#	500875-BB	500850-BB	500880-BB	500825-BB

Accessories



LoudMouth™ Installation Monitor

The LoudMouth monitors electric heating wire elements during the entire installation process and sounds an alarm if the heating elements are cut or damaged. Features include 9V battery power, on/off switch, indicator lights, test button & audible alarm.

Order# 81007474

Model# 423250ST



TapeMat® Double-Sided Tape

36 yard length of extra double-sided tape

Order# 81000051

Model# 423275ST



CableStrap™

CableStrap makes it easy to install WarmWire & SlabHeat at the desired spacing. Each 25 ft roll covers approximately 40 ft² to 50 ft² of heated floor area.

Order# 81005523

Model# 321301ST



Floor Sensor

This SunStat compatible sensor provides accurate sensing of the floor temperature.

Order# 81009178

Model# 500110



NEW Joint Tape

Use Joint Tape to seal the seams between rows of HeatMatrix™ in areas that are exposed to surface water. Joint Tape can also be used to span the seam at room edges where HeatMatrix and wall membranes meet.

Order# 81019457

Model# 8001GRY25R-ST

Accessories



CableTrowel™

CableTrowel is recommended for applying mortar over any Watts Radiant electric heating system. Consider using the 3/8" wide by 1/2" deep, U-shaped, notched CableTrowel for added peace of mind.

Order# 81007407

Model# 300400ST

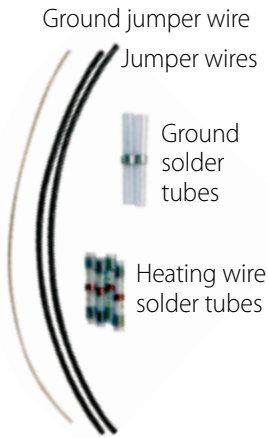

Heating Wire Repair Kit for Custom TapeMat, TapeMat, UnderFloor Mat & WarmWire

Before ordering this kit consult with the factory to make sure it is suitable for the type of repair you are making. This kit is used for Custom TapeMat, TapeMat, UnderFloor Mat & WarmWire systems. Do not use it for ShowerMat, SlabHeat or ProMelt systems. Kit includes materials for one repair: 2 jumper wires, 1 ground jumper wire, 2 ground solder tubes, and 4 heating wire solder tubes. Detailed written instructions are included.

Order# 81007142

Model# 200299ST

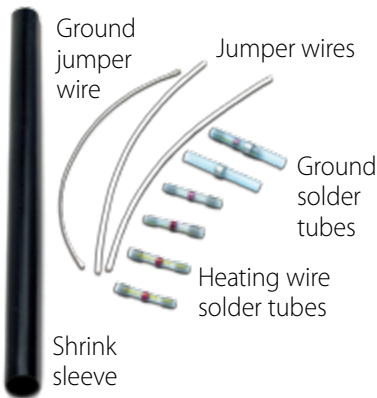

Heating Wire Repair Kit for SlabHeat

Before ordering this kit, consult with the factory to ensure it suits your type of repair. This kit is used for SlabHeat systems. Kit includes materials to make one repair: 2 jumper wires, 1 ground jumper wire, 2 ground solder tubes, 4 heating wire solder tubes, and 1 shrink sleeve. Detailed written instructions are included.

Order# 81012263

Model# 200400

ProMelt® Mats

- Reduce installation time with these simple-to-install mats
- Mats eliminate the need to secure every row of cable
- Embed in concrete, asphalt or sand
- Use for snow melting & patio heating
- 2' or 3' wide rolls
- 120, 208, and 240 VAC model options
- Multiple mats can be controlled by one contactor



Simply unroll the mat and secure to rewire or rebar. ProMelt Mats offer the fastest install option for rectangular shaped areas.



ProMelt offers a wide range of sizes to fit your project

Site-specific design calculations are recommended to ensure the system performs as expected. 38 watt/ft² mats are typically used in milder climates. 50 watt/ft² mats are better suited for colder climates and critical melting applications.



120 VAC ProMelt Mats (38 watts/ft²)

	Size (L x W)	Ft ²	Order#	Model#	Amps
2' Wide	5' x 2'	10	81011665	SM3812000524	3.2
	10' x 2'	20	81011667	SM3812001024	6.3
	15' x 2'	30	81011669	SM3812001524	9.5
	20' x 2'	40	81011671	SM3812002024	12.7
	25' x 2'	50	81011673	SM3812002524	15.8
	30' x 2'	60	81011675	SM3812003024	19.0

240 VAC ProMelt Mats (38 watts/ft²)

	Size (L x W)	Ft ²	Order#	Model#	Amps
2' Wide	10' x 2'	20	81014652	SM3824001024	3.2
	20' x 2'	40	81014653	SM3824002024	6.3
	30' x 2'	60	81014654	SM3824003024	9.5
	40' x 2'	80	81014655	SM3824004024	12.7
	50' x 2'	100	81014656	SM3824005024	15.8
	60' x 2'	120	81014657	SM3824006024	19.0

38 watts/ft²
(130 Btu/h/ft²)

208 VAC ProMelt Mats (50 watts/ft²)

	Size (L x W)	Ft ²	Order#	Model#	Amps
2' Wide	7' x 2'	14	81011593	SM5020800724	3.4
	11' x 2'	22	81011594	SM5020801124	5.3
	14' x 2'	28	81011595	SM5020801424	6.7
	18' x 2'	36	81011596	SM5020801824	8.7
	20' x 2'	40	81011597	SM5020802024	9.6
	24' x 2'	48	81011598	SM5020802424	11.5
	28' x 2'	56	81011599	SM5020802824	13.5
	34' x 2'	68	81011601	SM5020803424	16.3
	38' x 2'	76	81011602	SM5020803824	18.3
	42' x 2'	84	81011603	SM5020804224	20.2
	48' x 2'	96	81011604	SM5020804824	23.1

	Size (L x W)	Ft ²	Order#	Model#	Amps
3' Wide	5' x 3'	15	81011605	SM5020800536	3.6
	10' x 3'	30	81011607	SM5020801036	7.2
	15' x 3'	45	81011610	SM5020801536	10.8
	20' x 3'	60	81011612	SM5020802036	14.4
	25' x 3'	75	81011614	SM5020802536	18.0
	30' x 3'	90	81011616	SM5020803036	21.6

50 watts/ft²
(170 Btu/h/ft²)



Selecting the correct size mat

- Select a voltage.
- Calculate the watts/ft² required for system design.
- Calculate the ft² for each individually controlled zone.

240 VAC ProMelt Mats (50 Watts/ft²)

	Size (L x W)	Ft ²	Order#	Model#	Amps
2' Wide	8' x 2'	16	81011617	SM5024000824	3.3
	12' x 2'	24	81011618	SM5024001224	5.0
	16' x 2'	32	81011619	SM5024001624	6.7
	20' x 2'	40	81011620	SM5024002024	8.3
	24' x 2'	48	81011621	SM5024002424	10.0
	28' x 2'	56	81011622	SM5024002824	11.7
	32' x 2'	64	81011623	SM5024003224	13.3
	36' x 2'	72	81011624	SM5024003624	15.0
	40' x 2'	80	81011625	SM5024004024	16.7
	44' x 2'	88	81011626	SM5024004424	18.3
	48' x 2'	96	81011627	SM5024004824	20.0
52' x 2'	104	81011628	SM5024005224	21.7	

277 VAC ProMelt Mats are available via Special Order only. Please allow additional lead time.

3' Wide	5' x 3'	15	81011629	SM5024000536	3.1
	10' x 3'	30	81011631	SM5024001036	6.3
	15' x 3'	45	81011633	SM5024001536	9.4
	20' x 3'	60	81011635	SM5024002036	12.5
	25' x 3'	75	81011637	SM5024002536	15.6
	30' x 3'	90	81011639	SM5024003036	18.8
	35' x 3'	105	81011640	SM5024003536	21.9

50 watts/ft²
(170 Btu/h/ft²)



ProMelt® Cable

- Best option for stairs, curves & free-form areas
- Easily attached to rebar or rewire with ties
- Secures to existing concrete with CableStrap for patio heating applications
- For use with concrete, pavers, asphalt or tile
- Cable spaced at 3" OC for 50 Watts/ft² output or 4" OC for 38 watts/ft²
- Select from 120, 208 or 240 VAC cables
- Multiple cables controllable by one contactor



ProMelt® Cable

ProMelt Cable offers full flexibility in design. Cables are spaced at either 3" or 4" on center depending on the required heating output. The typical 3" spacing provides 50 watts/ft² (170 Btu/ft²). For milder climates, the 4" (38 watt/ft²) spacing may be considered. Site specific design calculations are recommended to ensure the system will perform as expected.

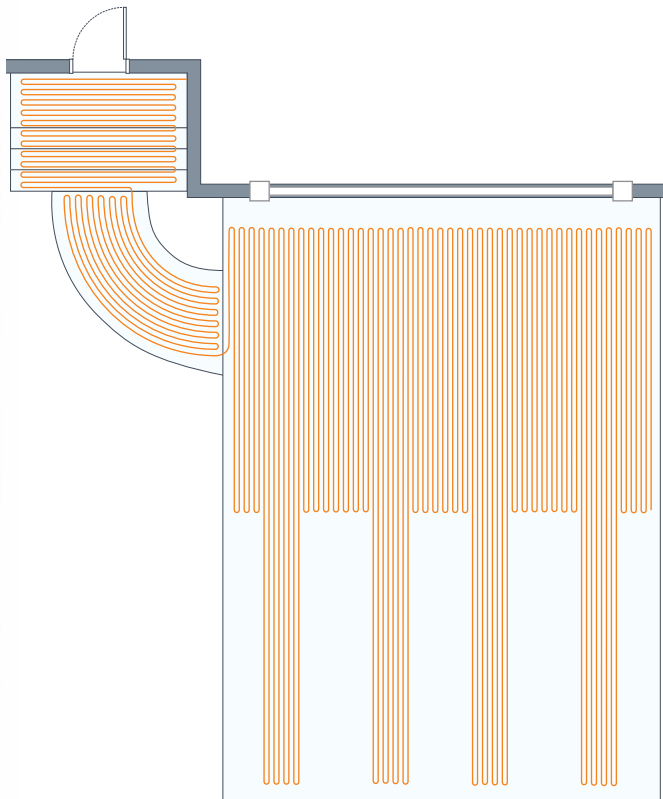

120 VAC Cable

Coverage (ft ²)		Length	Order#	Model#	Amps
3" o.c. (50 W/ft ²)	4" o.c. (38 W/ft ²)				
8	10	29'	81011367	SC50120008	3.3
15	20	59'	81011369	SC50120015	6.3
20	26	78'	81011370	SC50120020	8.3
30	39	118'	81011373	SC50120030	12.5
40	53	158'	81011376	SC50120040	16.7
53	69	208'	81011378	SC50120053	22.1



Cable Selection

- Calculate the required watts per square foot.
- Select a spacing option that will provide enough output for the expected performance of the snow melt system.
- Calculate the total area to be melted for each individually controlled zone.
- Determine which voltage will be used.
- Select a cable long enough to cover the melting area.

208 VAC Cable

Coverage (ft ²)		Length	Order#	Model#	Amps
3" o.c. (50 W/ft ²)	4" o.c. (38 W/ft ²)				
14	19	55'	81011408	SC50208014	3.4
20	26	78'	81011416	SC50208020	4.8
30	39	118'	81011417	SC50208030	7.2
35	46	138'	81011418	SC50208035	8.4
40	53	158'	81011383	SC50208040	9.6
45	59	178'	81011384	SC50208045	10.8
55	72	218'	81011385	SC50208055	13.2
60	79	238'	81011386	SC50208060	14.4
65	85	257'	81011387	SC50208065	15.6
75	98	297'	81011388	SC50208075	18.0
80	105	317'	81011389	SC50208080	19.2
90	118	357'	81011390	SC50208090	21.6

240 VAC Cable

Coverage (ft ²)		Length	Order#	Model#	Amps
3" o.c. (50 W/ft ²)	4" o.c. (38 W/ft ²)				
15	20	59'	81011391	SC50240015	3.1
25	33	98'	81011392	SC50240025	5.2
30	39	118'	81011393	SC50240030	6.3
40	53	158'	81011394	SC50240040	8.3
45	59	178'	81011395	SC50240045	9.4
55	72	218'	81011396	SC50240055	11.5
60	79	238'	81011397	SC50240060	12.5
65	85	257'	81011398	SC50240065	13.5
75	98	297'	81011399	SC50240075	15.6
80	105	317'	81011400	SC50240080	16.7
90	118	357'	81011401	SC50240090	18.8
105	137	417'	81011402	SC50240105	21.9

277 VAC ProMelt Cables are available via Special Order only. Please allow additional lead time.

ProMelt® Snow Melting Controls

- Compatible with ProMelt Cables & Mats
- Automatic and manual melting options
- Pole-mount, in-slab or surface-mount sensing
- Control options from 30 to 200 amps per unit
- 'All-in-one' control for smaller systems
- 24 VAC control with connection to Contactor-Pro for larger systems



Select the best control package for your installation.

- Total the amps of the mat and cable for each zone before comparing control options.
- Zones with less than 60 amps can use an all-in-one control solution (PM-2C or PM-5).
- The PM-654 & PM-519 connect to a ContactorPro panel to control zones of any size.

System Size	Operation	Sensor	Control	Required	Recommended
Up to 30 amp	Automatic start/timed stop melting		PM-2C	-	PM-DP
Up to 60 amp	Automatic start/timed stop melting		PM-5	-	PM-DP
Any Size	Automatic start & stop melting with slab temperature control	090	PM-654	ContactorPro Panel	-
Any Size	Automatic start/timed stop melting	095	PM-654	ContactorPro Panel	-
Any Size	Manual start & stop melting with slab temperature control	072	PM-654	ContactorPro Panel	-
Any Size	Outdoor patio heating (no snow melting)	072	PM-519	ContactorPro Panel	-



Sensor at top of control

ProMelt Snow Sensor Control PM-2C

The PM-2C operates on line voltage with a 30 amp capacity. This all-in-one control includes a snow sensor on the top-facing side. Features include automatic or manual operation, adjustable trigger temperature and an adjustable drying cycle.

Order# 81012640

Model# 300600HW

Ship wt: 3 lb

ProMelt Snow Sensor Control PM-5

The PM-5 operates on line voltage with a 60 amp capacity. This all-in-one control includes a snow sensor on the top facing side. Features include automatic or manual operation, adjustable trigger temperature and an adjustable drying cycle.

Order# 81014941

Model# 300580HW

Ship wt: 1 lb



ProMelt Snow Melting Control PM-654

The PM-654 is designed to operate electric or hydronic equipment to melt snow or ice from any surface including driveways, walkways, patios, business entrances, parking ramps, loading docks, hospital entrances, helipads or car wash bays. The surface temperature for snow melting is controlled automatically to reduce operating energy costs. The 654 has an automatic start and stop function when used with the Snow/Ice Sensor PM-090. Automatic start with a timed stop is available when used with the Snow Sensor PM-095. The 654 can operate a dedicated hydronic boiler or a mixing device. Isolation relays are required to operate line voltage pumps. Electric systems require a separate GFCI and electrical relay contactor.

Order# 81016552 Model# 300154 Ship wt: 1.3 lb



ProMelt Outdoor Heating Control Kit PM-519

Extend the patio season with ProMelt mats or cables. This control has a sensing range of -58°F to 140°F (-50°C to 60°C) and an adjustment range of 40 to 122°F (4.5 to 50°C). The included PM-072 sensor is used to measure the temperature under the heated outdoor slab or paver surface.

Order# 81016550 Model# 300152 Ship wt: 1 lb



ProMelt ContactorPro Panels

Control systems of any size when connected to a compatible ProMelt Control. ContactorPro Panels are available in 50, 100 and 200 amp models to operate systems with 120, 208, 240 or 277 VAC power. Panels include a 'System On' indicator light & manual override dial with a 4-hour timer. A built-in 24 VAC transformer provides power to the connected control. Each NEMA Type 1 panel measures 12" wide by 12" high by 4" deep & includes knockouts for conduit.

ContactorPro Panel	CP-50	CP-100	CP-200
Built-in amp capacity	50	100	200
Order#	81012645	81012646	81012647
Model#	300050HW	300100HW	300200HW



Safe, reliable control for ProMelt systems

ProMelt® Accessories



Outdoor Sensor PM-070

Replacement model for outdoor sensor included with the ProMelt control kits.

Order# 81000132 Model# 300137 Ship wt: 4 lb



Slab Sensor PM-072

This weather-resistant sensor is designed for installation in conduit within a concrete slab or in mortar between pavers.

Order# 81007203 Model# 300141 Ship wt: 1 lb



Snow / Ice Sensor PM-090

Detects the presence of snow & ice to enable fully automatic melting operation. Install within a Sensor Socket 091 once the surface is finished. Comes with 65' (20m) of wire.

Order# 81005661 Model# 300108 Ship wt: 3 lb



Sensor Socket PM-091

This socket includes an insert that keeps the socket free of debris during concrete or asphalt finishing. Secure conduit to cutout area to allow for installation of the Snow/Ice Sensor 090 once the surface is finished.

Order# 81003753 Model# 300111 Ship wt: 1.5 lb



Snow Sensor PM-095

The PM-095 enables automatic start/timed stop operation when connected to a Snow Melting Control PM-653. This pole-mounted sensor is commonly used in systems that require a sensor to be installed after the snow melt surface is finished.

Order# 81016553 Model# 300155 Ship wt: 1 lb



ProMelt Display Panel PM-DP

Connect to ProMelt PM-2C or PM-5 Snow Sensor Controls for remote adjustment and monitoring of the system. Panel includes buttons to switch between manual on, standby (off) and automatic operation. The ProMelt Display Panel also provides a connection for home automation systems to enable melting operation.

Order# 81012641 Model# 300650HW Ship wt: 2 lb



Snow Melting Plaque

Permanent aluminum plaque to indicate where a snow melting system has been installed.

Order# 81012651

Model# 100123HW

Ship wt: 2 lb



Cable Ties

6" cable ties are used to tie ProMelt Mat & Cable to rewire or rebar. 100 ties are included in a package.

Order# 81012649

Model# 321400HW

Ship wt: 1 lb



CableStrap™

CableStrap makes it easy to install WarmWire & SlabHeat at the desired spacing. Each 25 ft roll covers approximately 40 ft² to 50 ft² of heated area.

Order# 81005523

Model# 321301ST

Ship wt: 3 lb

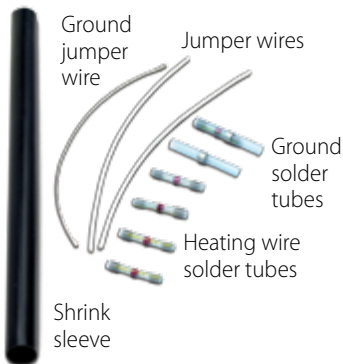

Heating Wire Repair Kit for SlabHeat & ProMelt

Before ordering this kit, consult with the factory to ensure it suits your type of repair. This kit is used for SlabHeat & ProMelt systems. Kit includes materials to make one repair: jumper wires, 1 ground jumper wire, 2 ground solder tubes, 4 heating wire solder tubes, and 1 shrink sleeve. Detailed written instructions are included.

Order# 81012263

Model# 200400

Ship wt: 1 lb

⚠ CAUTION

This brochure is not intended to provide full installation instructions and safety information. In order to avoid property damage or injury, please refer to the complete installation manual and product safety information provided with the product.

Rely on the radiant experts for quality heating and snow melting components. From tubing and fittings to controls and electric radiant cables, Watts Radiant has you covered.



WattsRadiant™

A WATTS Brand

USA: Tel: (800) 276-2419 • Fax: (417) 864-8161 • WattsRadiant.com

Canada: Tel: (905) 332-4090 • Fax: (905) 332-7068 • Watts.ca

Latin America: Tel: (52) 81-1001-8600 • Fax: (52) 81-8000-7091 • WattsRadiant.com