

MONGUZZI DI USUELLI JOLE & FIGLI S.N.C

VIA XX SETTEMBRE N°18

20061 CARUGATE (MI) ITALIA

TELEF.02/9253802

DISEGNI ELETTRICI

TAGLIERINA DOPPIA LAMA

MOD.TRM-2L

TR2

TR3

AZIONAMENTO
MOTOR PRESSING

122

KM1 KM2 KM3A KM5 KM6 K23 K24 K1 K2 K3 K5 K6 K7

122

K8 K9 K10 K11 K12 K13 K14 K15 K16

KM1 KM2 TR1

K17 K18 K20 K21 K22 K23 K24 K25 K26 K27

CONNETTORI

N°9 3HP 16P
N°10 1HP 6P
N°11 2HP 6P

CONNETTORI

N°12 6P
N°13 10HP



CONNETTORI

N°1 6P
N°2 10P
N°3 10P
N°4 10P
N°5 10P
N°6 16P
N°7 30P
N°8 16P

DISPOSIZIONE APPARECCHIATURE QUADRO

F.1+18

ITALIA - NORME

SCHEMA FUNZIONALE

TRM-24

MONGELLI CARUGATE

DATA 2-2-85
D.S. [signature]

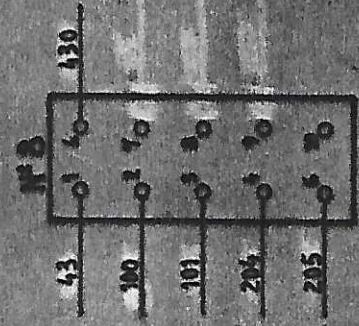
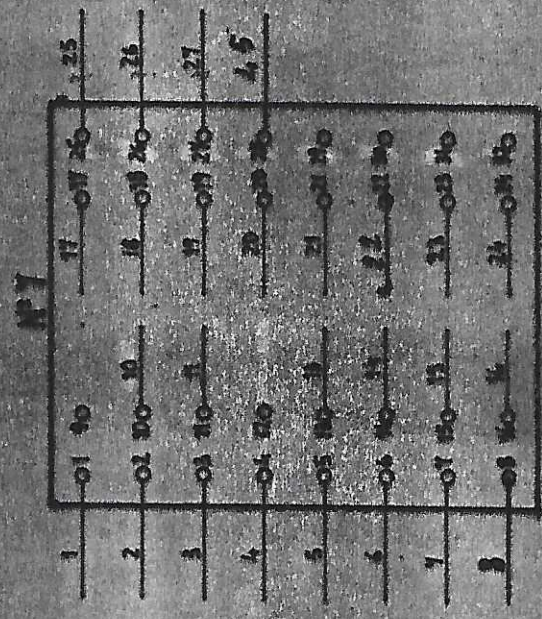
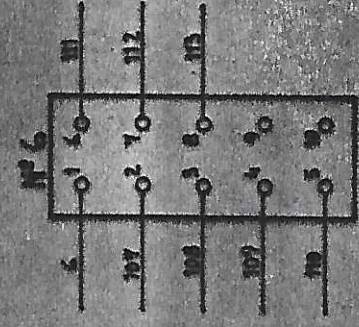
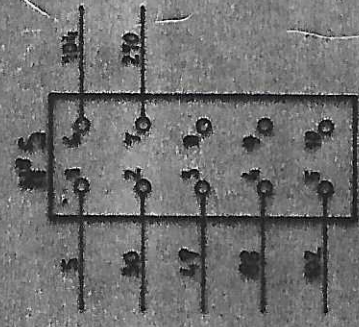
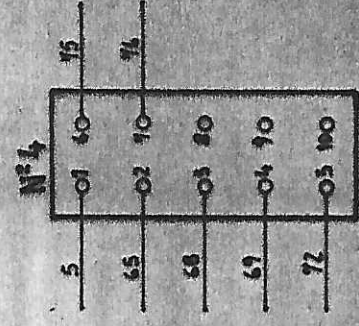
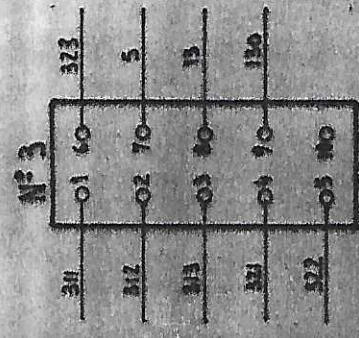
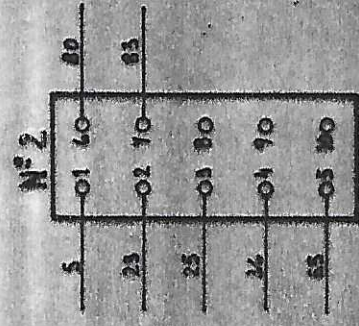
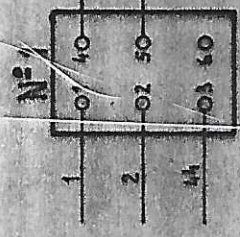

CONNETTORI AUSILIARI

DATA	2-2-85
D.S.	MP

MONGUZZI
CARUGATE

TRM-2L

SCHEMA
FUNZIONALE
ITALIA

1 2 3 4 5 6 7 8

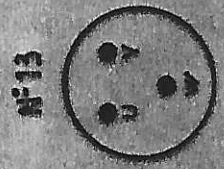
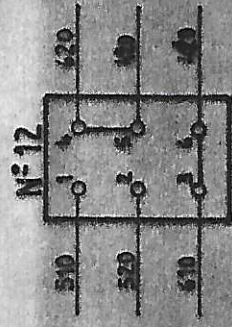
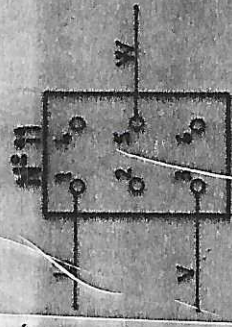
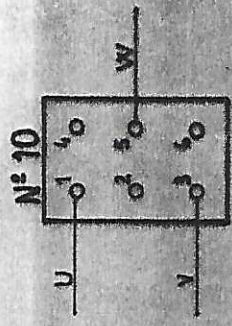
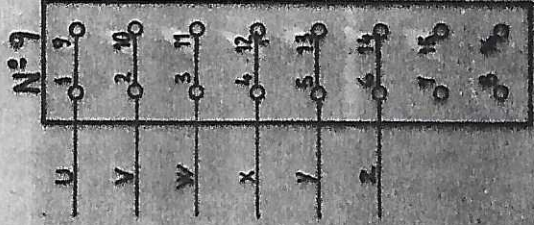

CONNETTORI FUORI QUADRO

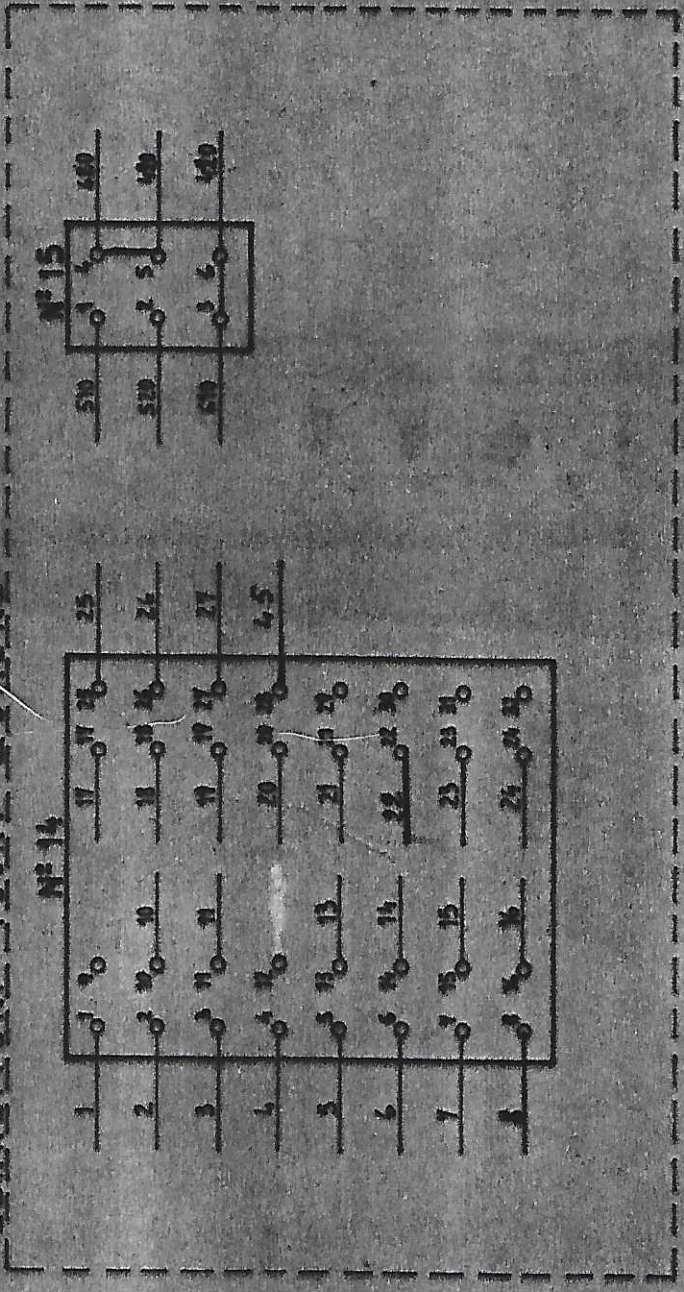

CONNETTORI DI POTENZA

DATA	2-2-80
D/S	1/100

MONGUZZI
CARUGATE

TR17-2L

SCHEMA
FUNZIONALE

ITALIA: NORME

F3-18

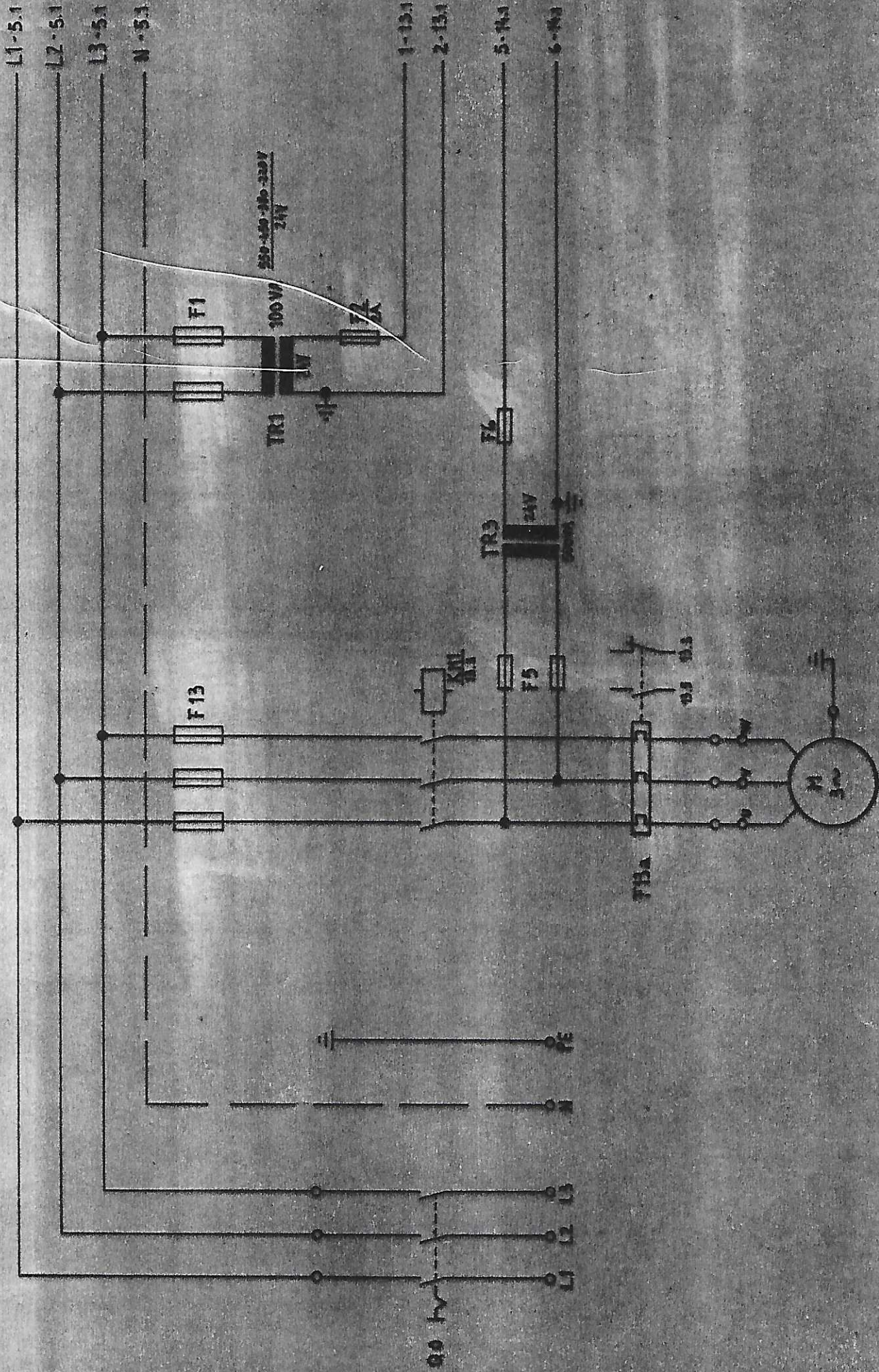

MOTORE CENTRALINA 10MP

MONGOLZI
CARUGATE

TRM-2L

SCHEMA
FUNZIONALE

ITALIA : NORME

F4-18

DATA 2-2-85
DIS. [signature]

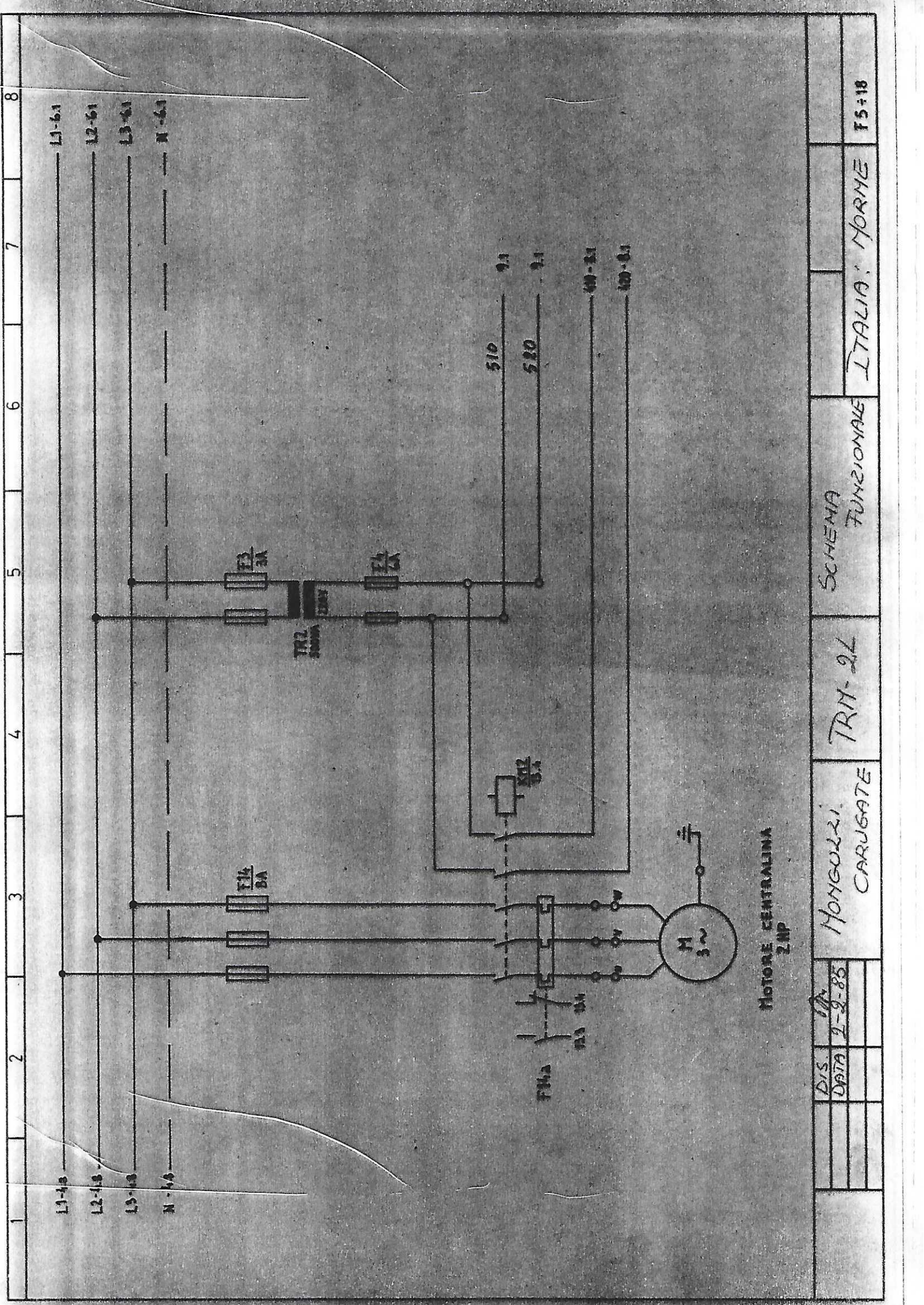

MOTORE CENTRALINA
2 HP

DIS. DATA	TRN-2L	SCHEMA FUNZIONALE	ITALIA: NORME	FS-18
DATA 2-2-85	MONGOLZI CARUGATE			

1 2 3 4 5 6 7 8

- L1-5.0
- L2-5.0
- L3-5.0
- N-5.0
- L1-7.1
- L2-7.1
- L3-7.1
- N-7.1

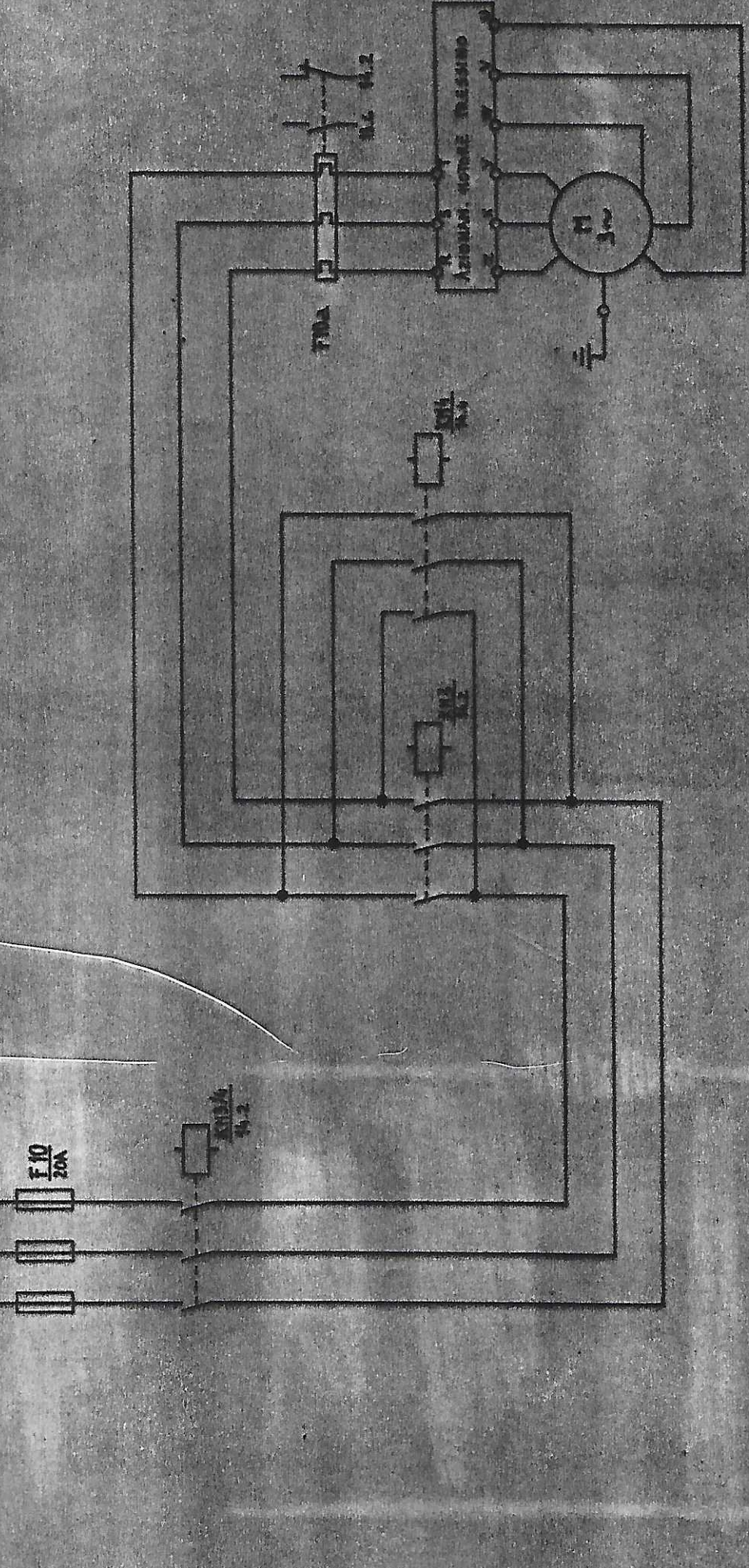

MOTORE PRESSINO
3HP

DATA 2-3-85
DIS. [Signature]

MONGUZZI
CARUGATE

TRM-2L

SCHEMA
FUNZIONALE

ITALIA - NORME

FL+10

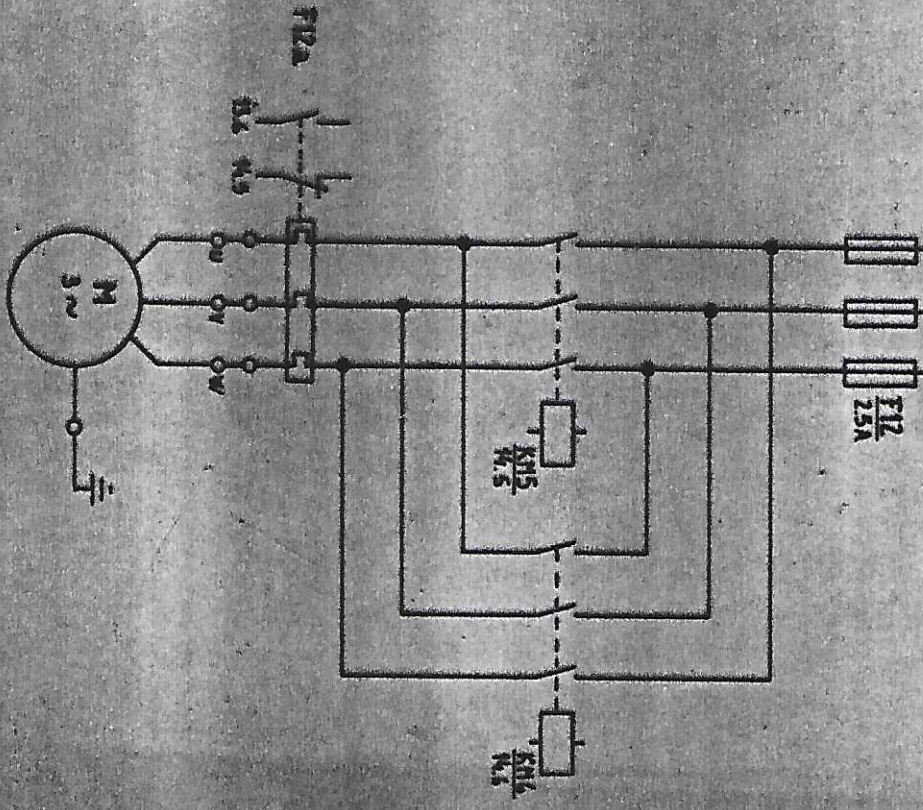

MOTORE REGISTRAD
1HP

DATA	2-2-85	MONGUZZI	TRM-21	SCHEMA	ITALIA	NORME	F1-1B
D.S.	IMP.	CRUGATE		FUNZIONALE			

410-57
420-57

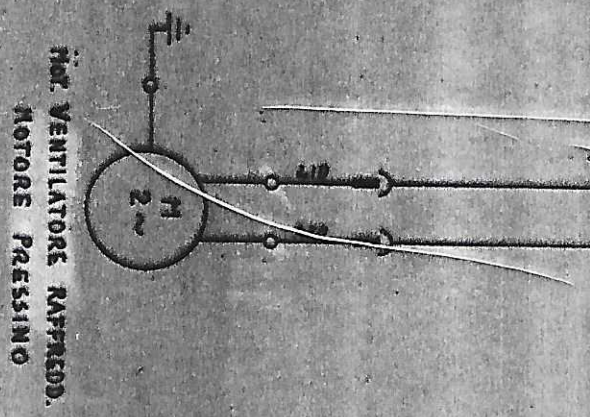

MOTORE VENTILATORE RAPPELLO.
MOTORE PRESSINO

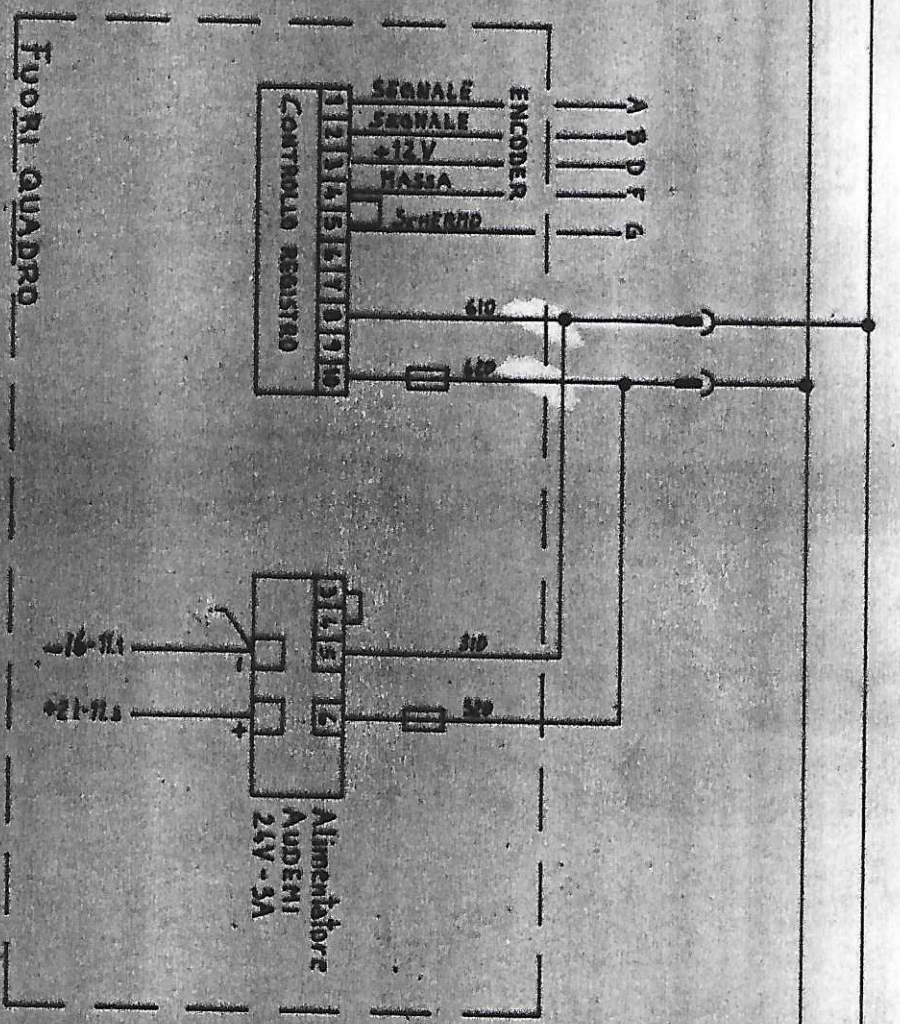

DATA 9-9-85
D/S APP.

HONGDZ1
CARBATE

TRH-2L

SCHEMA
FUNZIONALE

ITALIA : NORME

78-18

1 2 3 4 5 6 7 8

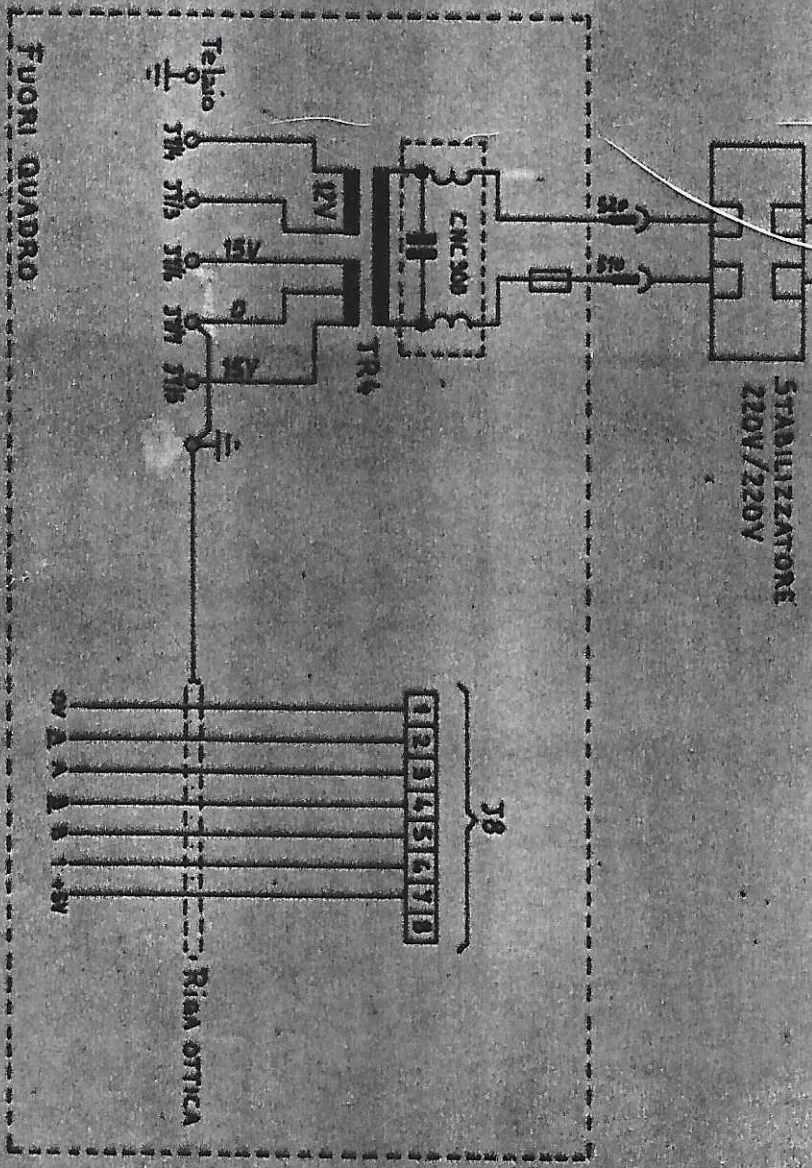
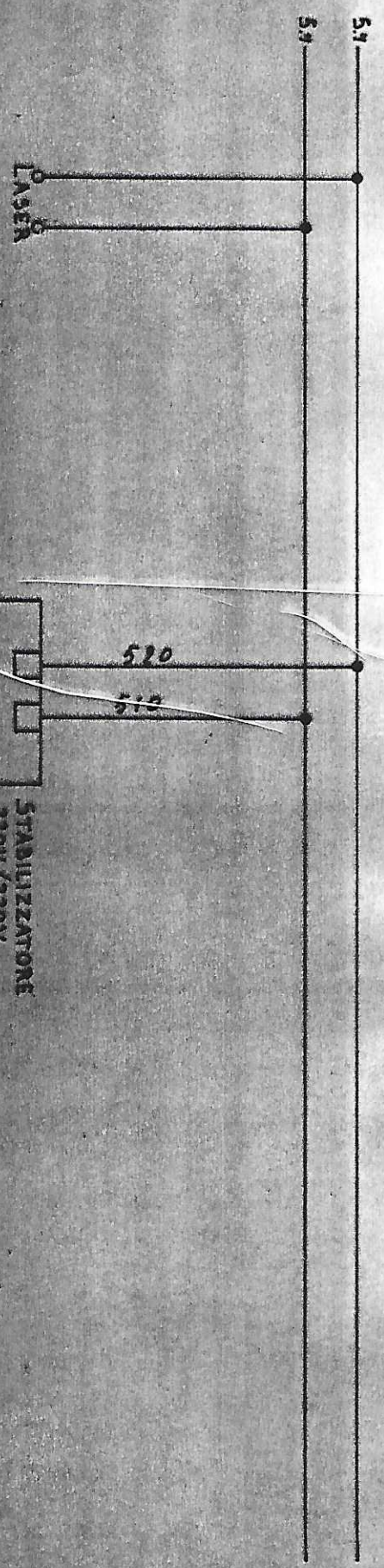

MONGUZZI
CARUGATE

TRM-2L

SCHEMA
FUNZIONALE

ITALIA : NORME

F9-18

DATA 8-9-85
D.S. MRS

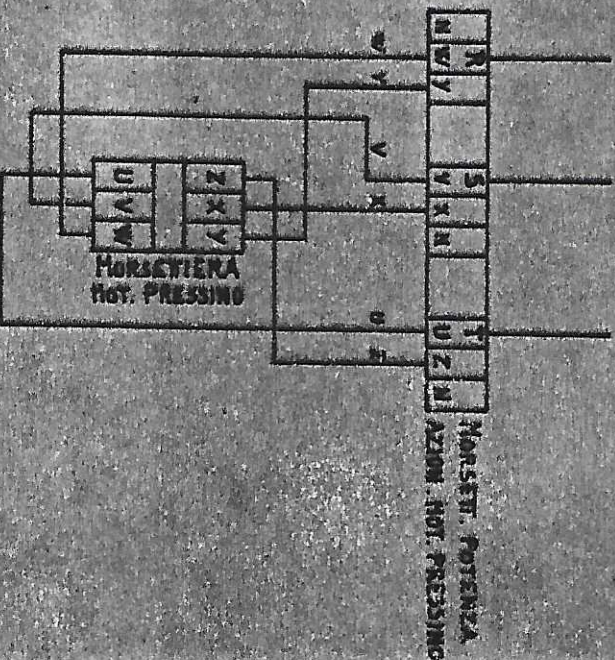
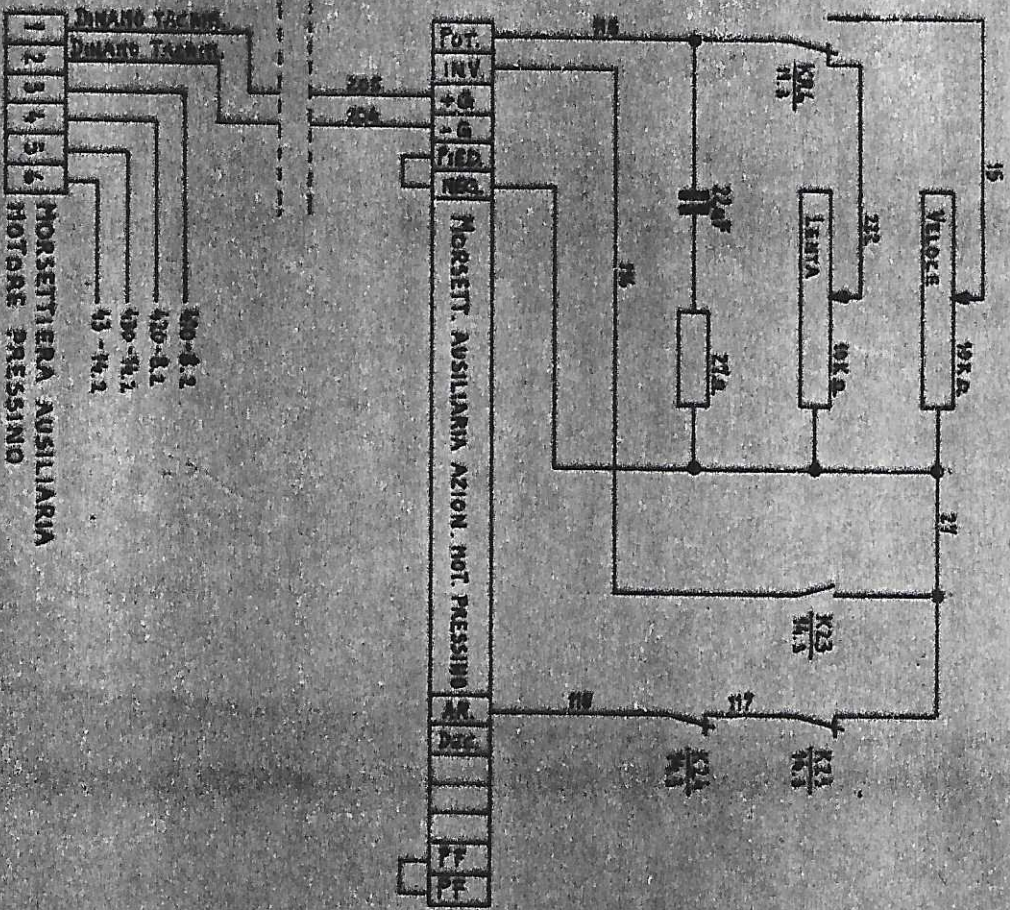

DINAMO TACQUE
DINAMO TACQUE
1
2
3
4
5
6
MORSETTIERA AUSILIARIA
HOTONAE PRESSINGO
100-8.2
100-8.1
100-9.1
43-14.2

DATA
D.S.
2-2-85
D.D.

NOMIGUZZI
CARUGATE
TRM-21

SCHEMA
FUNZIONALE

ITALIA : NORME

F 10-18

1 2 3 4 5 6 7 8

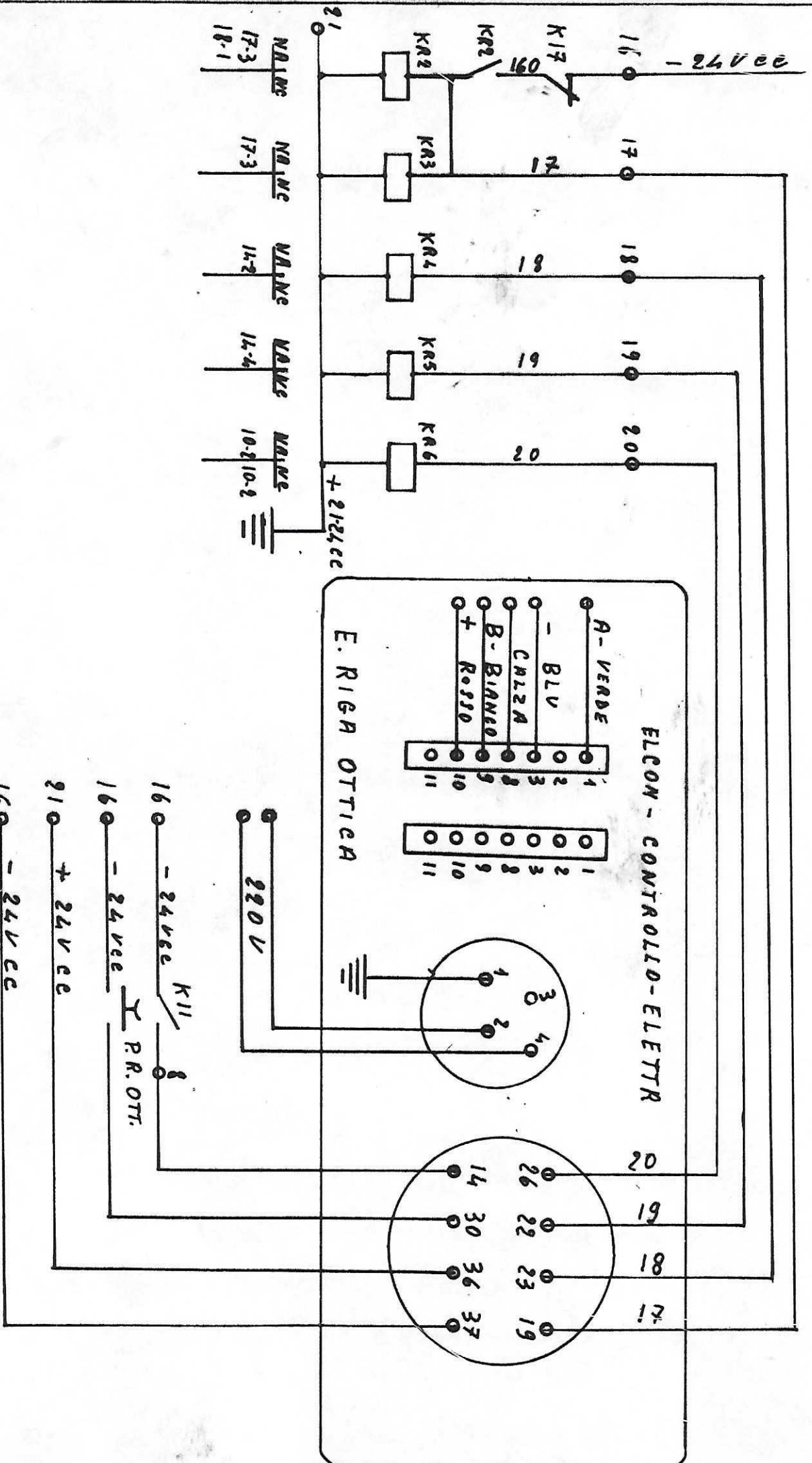

MONGUZZI
CARVATE I

TABELIERINA

MOD. TRM-2L

NORHE: VDE-05A-VL

F 11-18

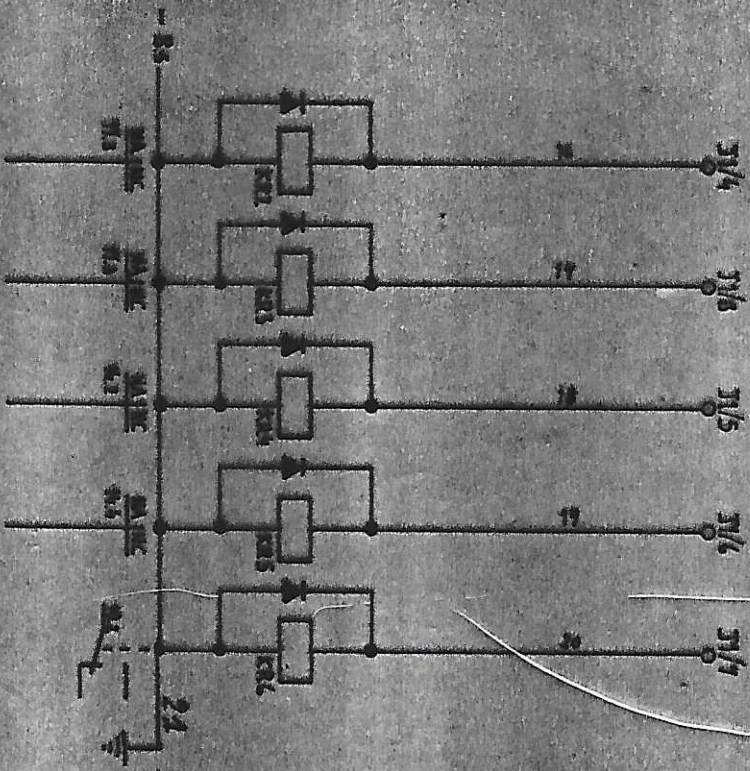

DIODI IN 1001
 REF. 2W1/2L 50mA

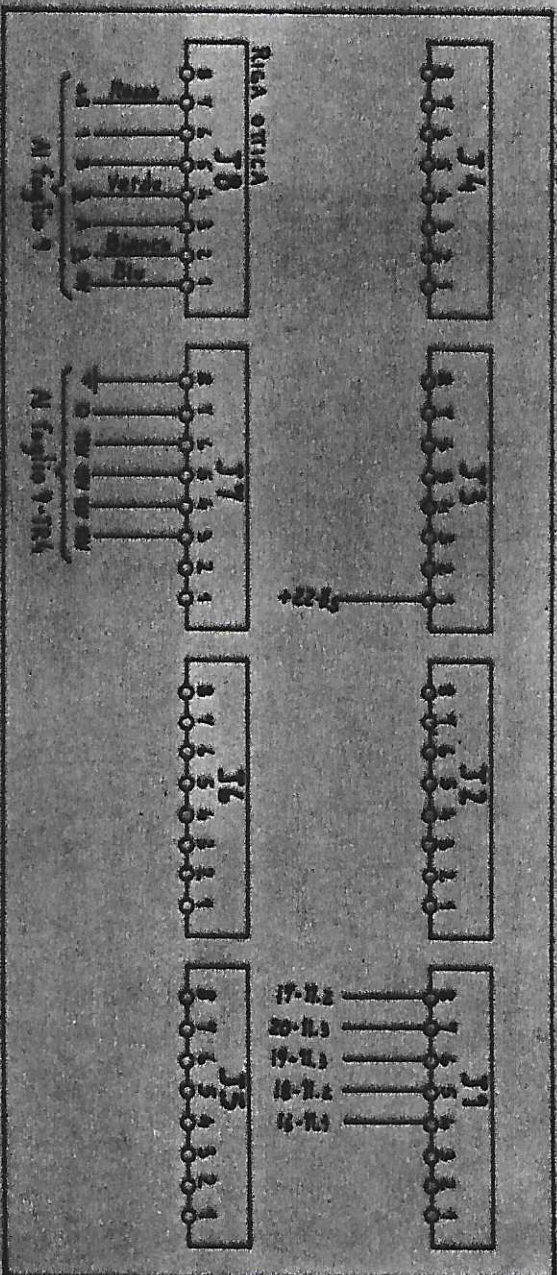

DATA 2-9-85	MONGOZZI	TRM-2L	SCHEMA	ITALIA. NORME	F11-1B
D/S. 1/10	CARUGATE		FUNZIONALE		

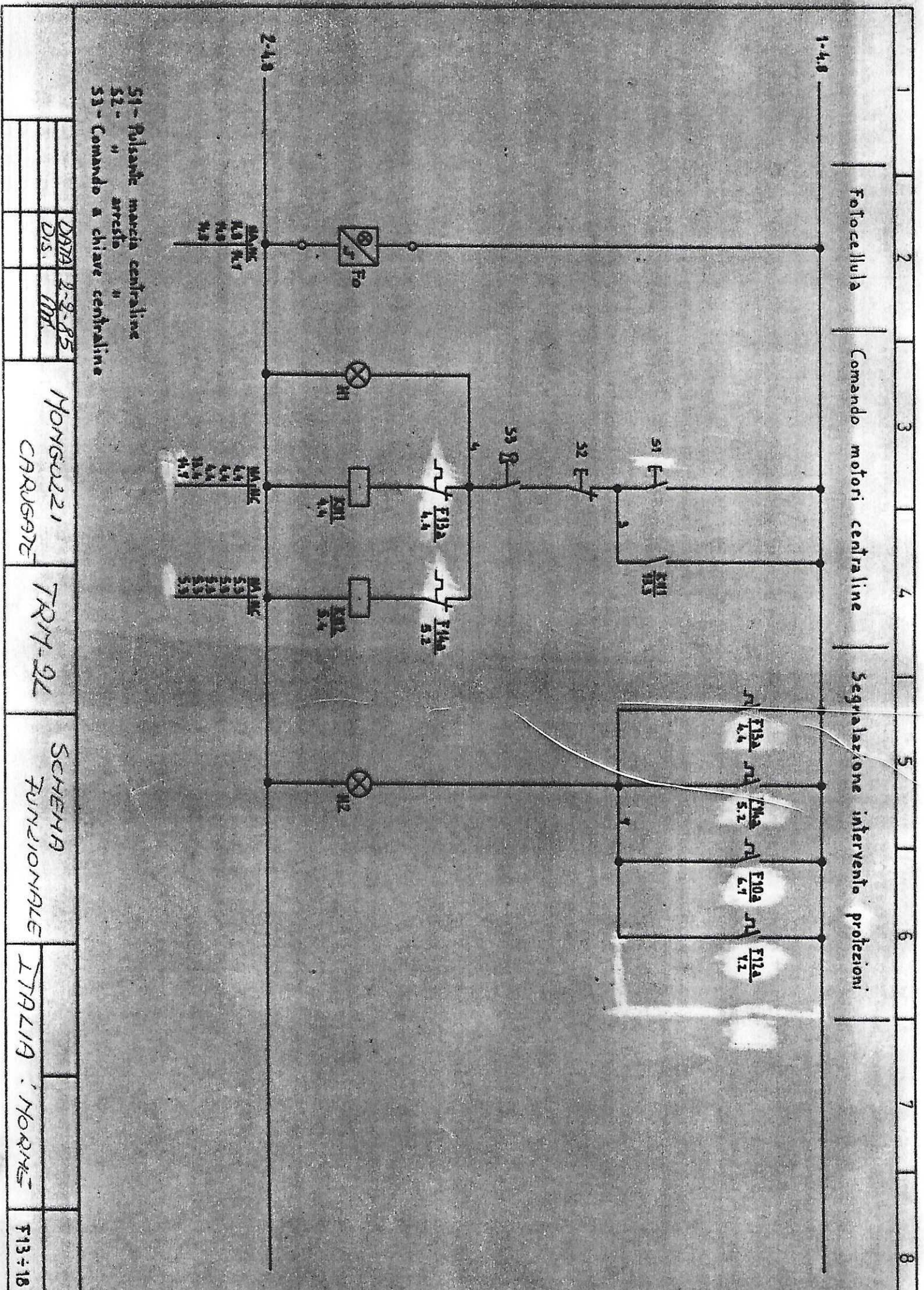

- 51 - Pulsante marcia centrale
- 52 - " arresto "
- 53 - Comando a chiave centrale

DATA	2-8-85	NONSU221	TRM-2L	SCHEMA	
D.S.	MM	CRUGATE		FUNZIONALE	
				ITALIA	MORNE
					F13-18

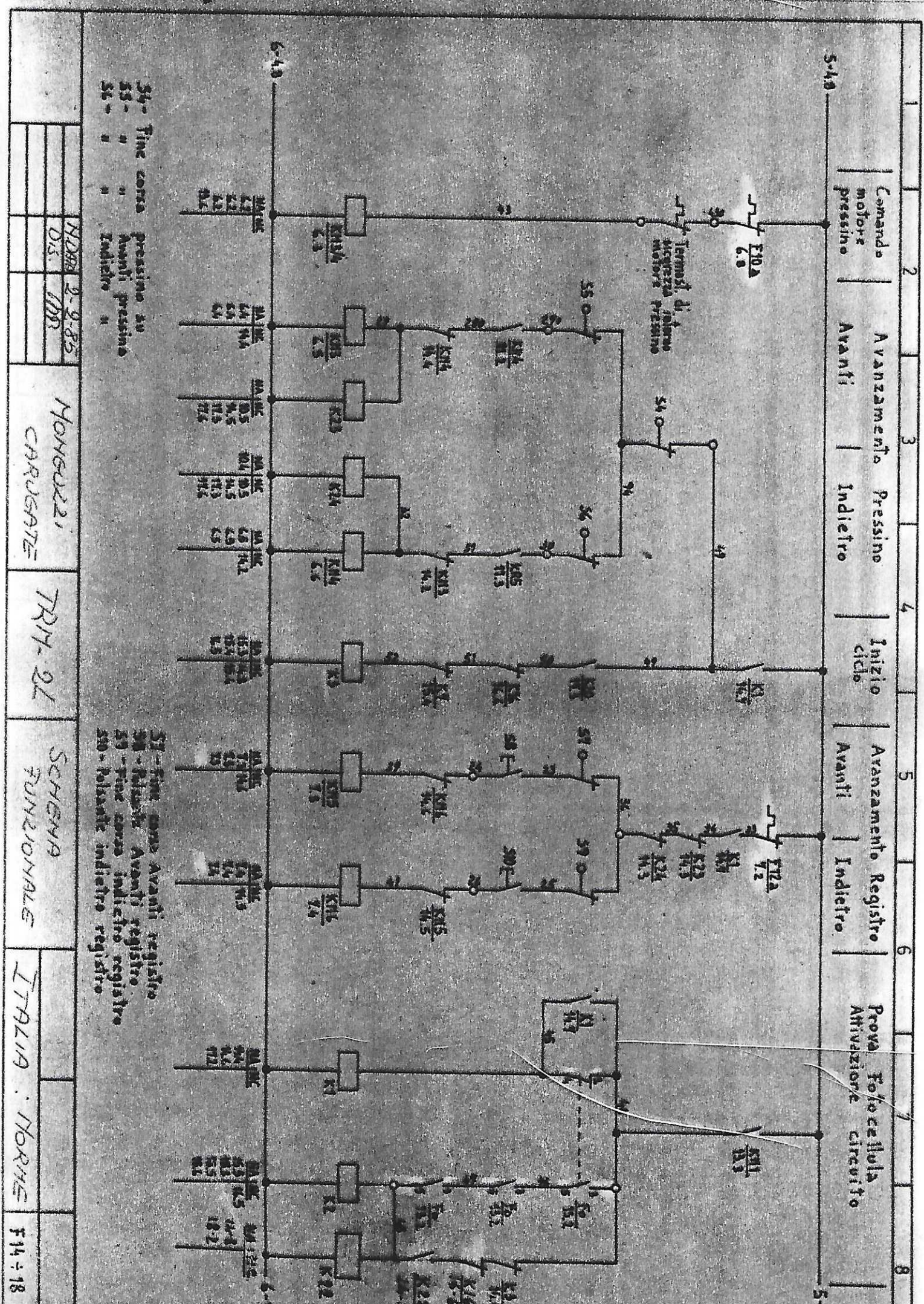

54 - Fine corsa pressione su
 55 - " " Avanti pressione
 56 - " " Indietro "

57 - Fine corsa Avanti registro
 58 - Rilascio Avanti registro
 59 - Fine corsa Indietro registro
 510 - Rilascio Indietro registro

MOD. 2-9-85
 D.S. 100
 MORGUZZI
 CARUGATE
 TRM-2L
 SCHEMA
 FUNZIONALE
 ITALIA : NORHE
 F14-18

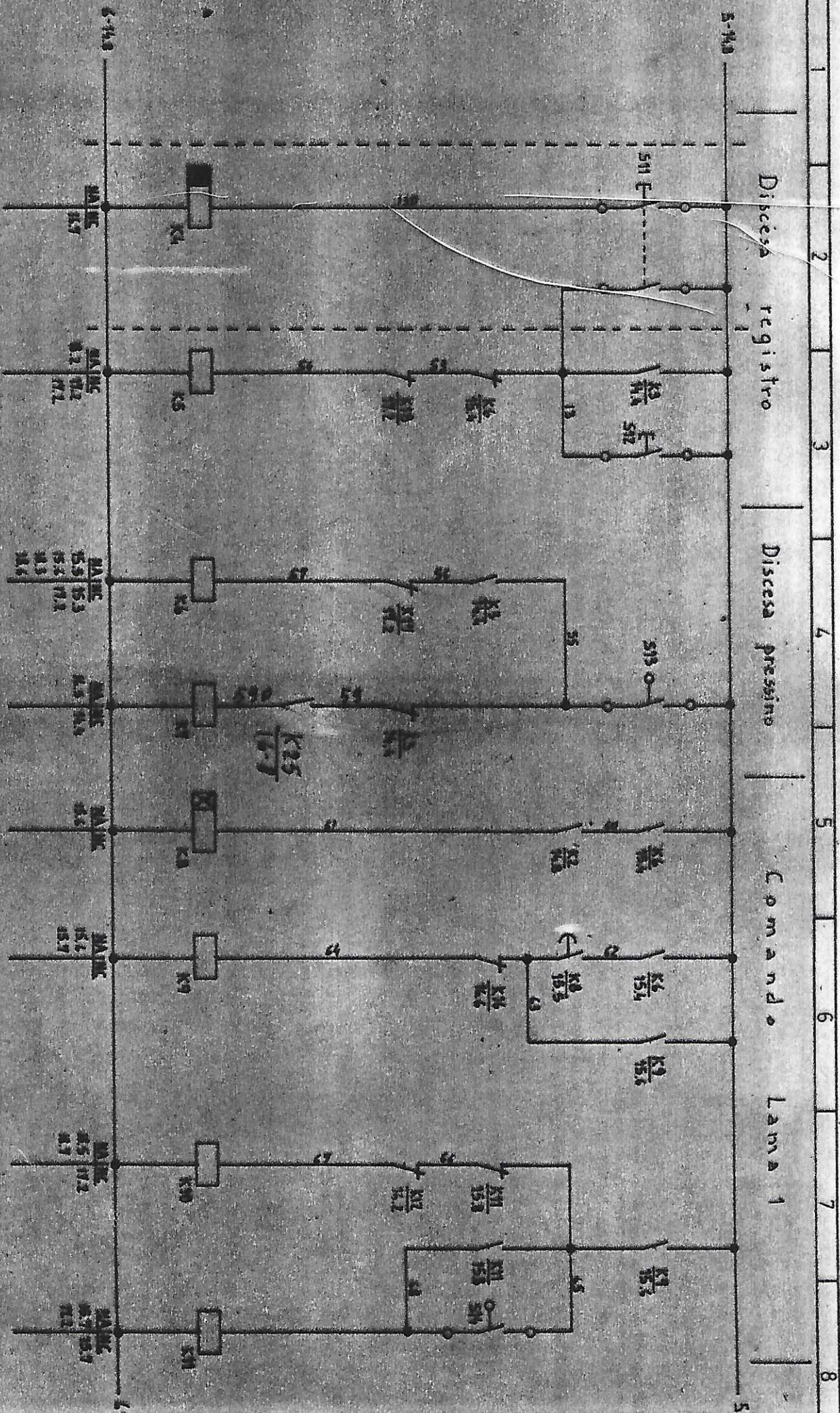

511- Pulsante comando a ginocchio discesa registro
 512- Pulsante discesa registro

513- Fine corsa registro

514- Fine corsa foglio lama 1

DATA	9-9-85	MONGILI	TRM-21	SCHEMA	ITRALIA	F15 ÷ 18
DIV	100	CARUGATE		FUNZIONALE	NORME	

Comando Lama 2

Fine Ciclo

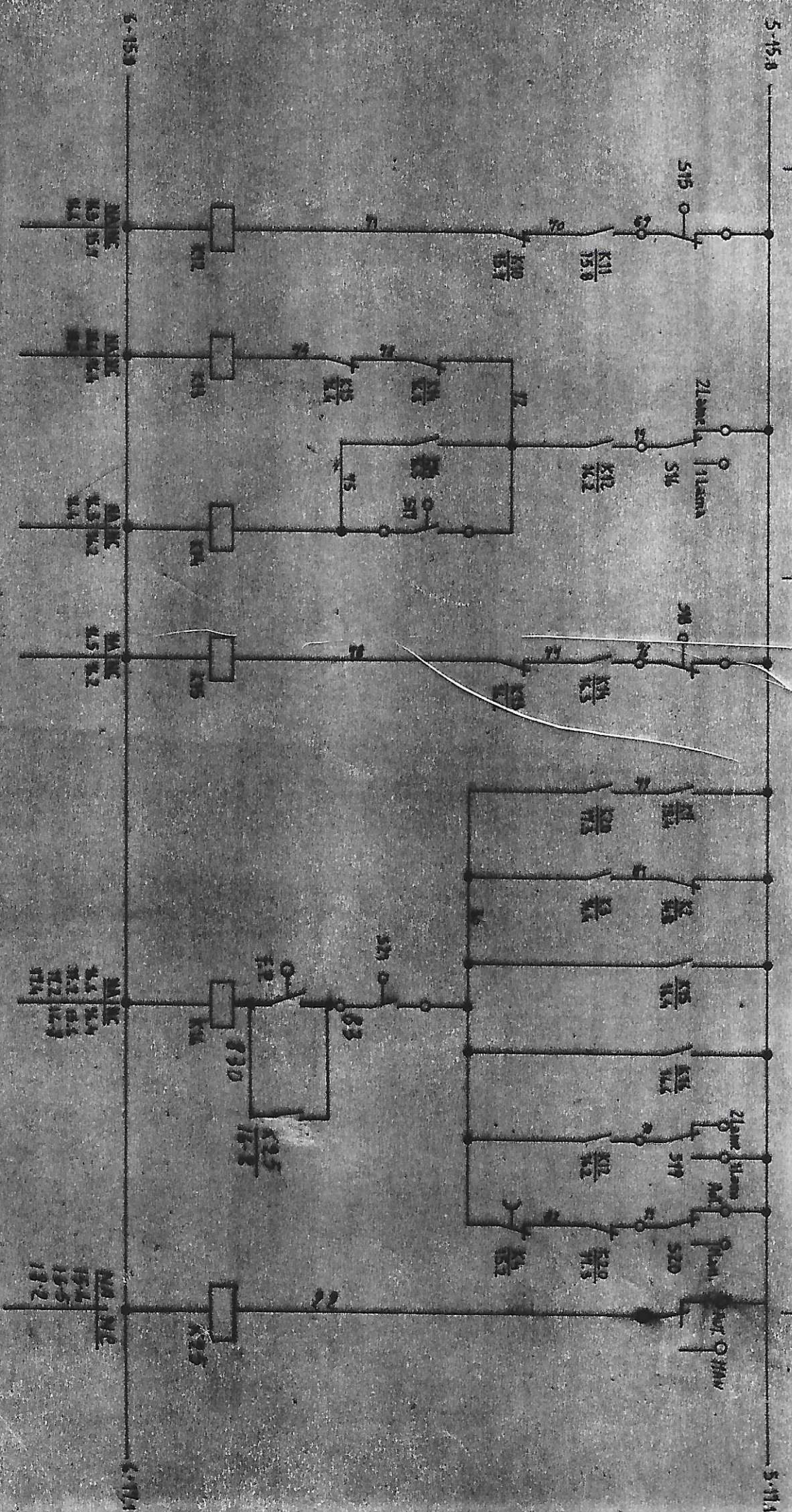

515 - Fine corsa lama 1
 516 - Comandatore 1 lama - 2 lame
 517 - Fine corsa Taglio lama 2

518 - Fine corsa lama 2

519 - Comandatore 1 lama - 2 lame
 520 - Azion. - Manuale

DATA	2-8-85	MONTEGUSCI	TRM-2L	SCHEMA	ITALLIA: NOBYE	F14-18
	D.S. 105	CARUGATE		FUNZIONALE		

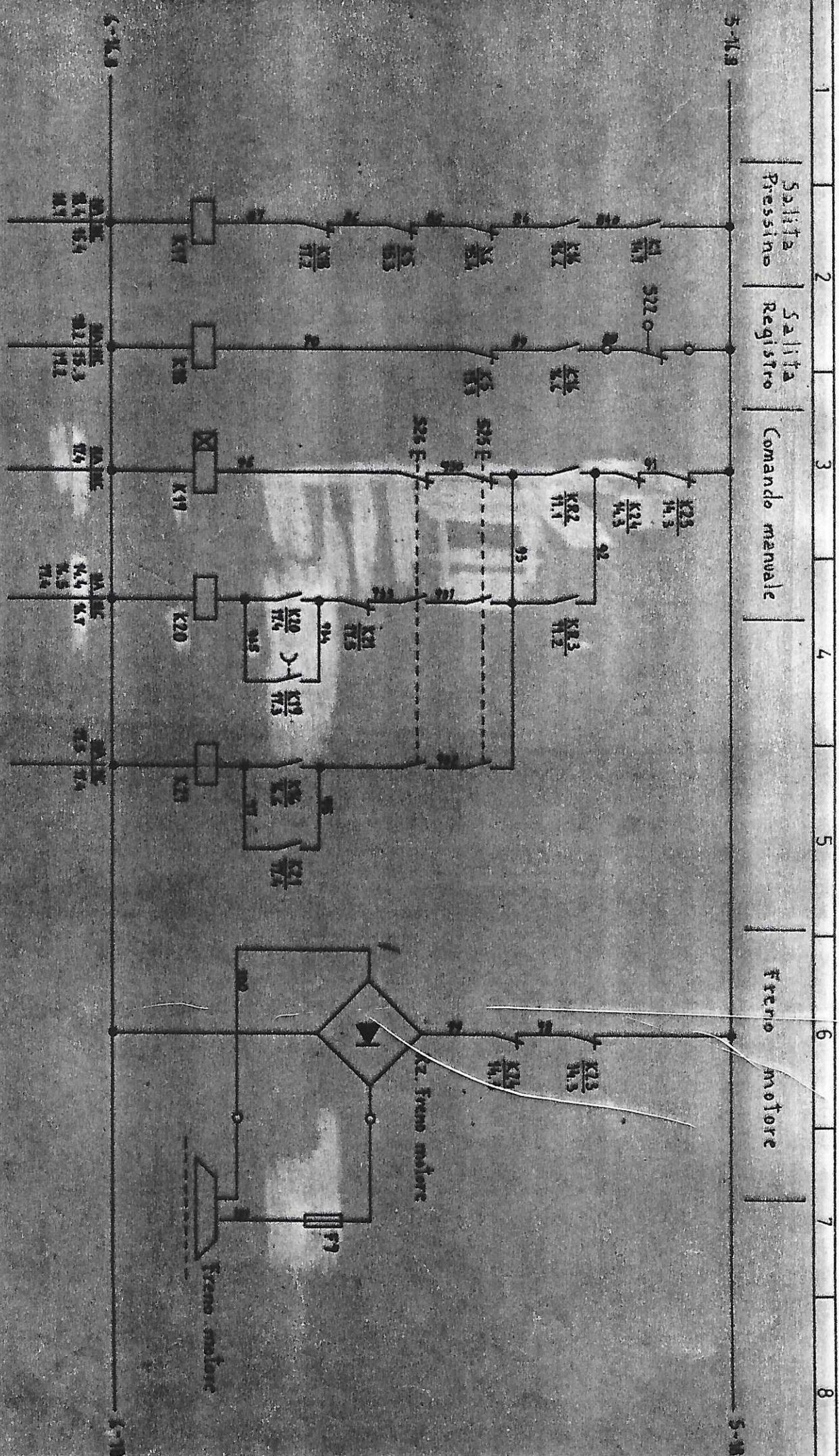

S22 - Time corsa pressino 30

DATA	2-9-85	MONGUZZI	TRM. 2L	SCHEMA	FUNZIONALE	ITALIA - NOBINK	F11 + 1B
D.S.	MB						