

Fremanezumab for the Preventive Treatment of Chronic Migraine

N Engl J Med. 2017;377:2113-22

Overview

During this Reprint Review program, there will be a presentation and discussion of the phase 3 clinical trial in chronic migraine as reported in the peer-reviewed and published article.

Topics

- Pivotal phase 3 clinical trial design
- Baseline patient characteristics
- Primary and secondary endpoint results
- Adverse events reported in the clinical trial

INDICATION

AJOVY® (fremanezumab-vfrm) injection is indicated for the preventive treatment of migraine in adults.

IMPORTANT SAFETY INFORMATION

Contraindications: AJOVY is contraindicated in patients with serious hypersensitivity to fremanezumab-vfrm or to any of the excipients.

Hypersensitivity Reactions: Hypersensitivity reactions, including rash, pruritus, drug hypersensitivity, and urticaria were reported with AJOVY in clinical trials. Most reactions were mild to moderate, but some led to discontinuation or required corticosteroid treatment. Most reactions were reported from within hours to one month after administration. If a hypersensitivity reaction occurs, consider discontinuing AJOVY and institute appropriate therapy.

Adverse Reactions: The most common adverse reactions (≥5% and greater than placebo) were injection site reactions.

Please see the accompanying full Prescribing Information for AJOVY.

Moderated by

Faculty Moderator

Andrew Blumenfeld, MD
Director
The Headache Center of Southern California

Date

Wednesday, March 11, 2020 6:30 PM

Venue Name

Cotton Row Restaurant
100 Southside Square
Huntsville, AL, 35801

Register

RSVP to Teva Representative(s):

Joey Coons
(205) 381-1717
ronald.coons@tevapharm.com

Angela Turner
(205) 821-4953
angie.turner@tevapharm.com;



HIGHLIGHTS OF PRESCRIBING INFORMATION

These highlights do not include all the information needed to use AJOVY safely and effectively. See full prescribing information for AJOVY.

AJOVY® (fremanezumab-vfrm) injection, for subcutaneous use Initial U.S. Approval: 2018

INDICATIONS AND USAGE

AJOVY is a calcitonin gene-related peptide antagonist indicated for the preventive treatment of migraine in adults. (1)

DOSAGE AND ADMINISTRATION

- For subcutaneous use only. (2.1, 2.2)
- Two subcutaneous dosing options of AJOVY are available to administer the recommended dosage:
 - 225 mg monthly, or
 - 675 mg every 3 months (quarterly) (2.1)
- The 675 mg quarterly dosage is administered as three consecutive injections of 225 mg each. (2.1)
- Administer in the abdomen, thigh, or upper arm subcutaneously. (2.2)
- See Dosage and Administration for important administration instructions. (2.2)

FULL PRESCRIBING INFORMATION: CONTENTS*

- INDICATIONS AND USAGE
- DOSAGE AND ADMINISTRATION
 - Recommended Dosage
 - Important Administration Instructions
- DOSAGE FORMS AND STRENGTHS
- CONTRAINDICATIONS
- WARNINGS AND PRECAUTIONS
 - Hypersensitivity Reactions
- ADVERSE REACTIONS
 - Clinical Trials Experience
 - Immunogenicity
- USE IN SPECIFIC POPULATIONS
 - Pregnancy
 - Lactation
 - Pediatric Use
 - Geriatric Use

FULL PRESCRIBING INFORMATION

1 INDICATIONS AND USAGE

AJOVY is indicated for the preventive treatment of migraine in adults.

2 DOSAGE AND ADMINISTRATION

2.1 Recommended Dosage

Two subcutaneous dosing options of AJOVY are available to administer the recommended dosage:

- 225 mg monthly, or
- 675 mg every 3 months (quarterly), which is administered as three consecutive subcutaneous injections of 225 mg each.

When switching dosage options, administer the first dose of the new regimen on the next scheduled date of administration. If a dose of AJOVY is missed, administer as soon as possible. Thereafter, AJOVY can be scheduled from the date of the last dose.

2.2 Important Administration Instructions

AJOVY is for subcutaneous use only.

AJOVY may be administered by healthcare professionals, patients, and/or caregivers. Prior to use, provide proper training to patients and/or caregivers on the preparation and administration of AJOVY prefilled syringe, including aseptic technique [see *Instructions for Use*].

- Remove AJOVY from the refrigerator. Prior to use, allow AJOVY to sit at room temperature for 30 minutes protected from direct sunlight. Do not warm by using a heat source such as hot water or a microwave. Do not use AJOVY if it has been at room temperature for 24 hours or longer [see *How Supplied/ Storage and Handling (16.2)*].
- Follow aseptic injection technique every time AJOVY is administered.
- Inspect AJOVY for particles or discoloration prior to administration [see *Dosage Forms and Strengths (3)*]. Do not use if the solution is cloudy, discolored, or contains particles.
- Administer AJOVY by subcutaneous injection into areas of the abdomen, thigh, or upper arm that are not tender, bruised, red, or indurated. For multiple injections, you may use the same body site, but not the exact location of the previous injection.
- Do not co-administer AJOVY with other injectable drugs at the same injection site.

3 DOSAGE FORMS AND STRENGTHS

AJOVY is a sterile, clear to opalescent, colorless to slightly yellow solution, available as follows:

- Injection: 225 mg/1.5 mL single-dose prefilled syringe

4 CONTRAINDICATIONS

AJOVY is contraindicated in patients with serious hypersensitivity to fremanezumab-vfrm or to any of the excipients [see *Warnings and Precautions (5.1)*].

DOSAGE FORMS AND STRENGTHS

Injection: 225 mg/1.5 mL solution in a single-dose prefilled syringe. (3)

CONTRAINDICATIONS

AJOVY is contraindicated in patients with serious hypersensitivity to fremanezumab-vfrm or to any of the excipients. (4)

WARNINGS AND PRECAUTIONS

Hypersensitivity Reactions: If hypersensitivity occurs, consider discontinuing AJOVY and institute appropriate therapy. (5.1)

ADVERSE REACTIONS

The most common adverse reactions (≥5% and greater than placebo) were injection site reactions. (6.1)

To report SUSPECTED ADVERSE REACTIONS, contact Teva Pharmaceuticals at 1-888-483-8279 or FDA at 1-800-FDA-1088 or www.fda.gov/medwatch.

See 17 for PATIENT COUNSELING INFORMATION and FDA-approved patient labeling. Revised: 1/2019

11 DESCRIPTION

12 CLINICAL PHARMACOLOGY

- Mechanism of Action
- Pharmacodynamics
- Pharmacokinetics

13 NONCLINICAL TOXICOLOGY

- Carcinogenesis, Mutagenesis, Impairment of Fertility

14 CLINICAL STUDIES

16 HOW SUPPLIED/STORAGE AND HANDLING

- How Supplied
- Storage and Handling

17 PATIENT COUNSELING INFORMATION

*Sections or subsections omitted from the full prescribing information are not listed.

5 WARNINGS AND PRECAUTIONS

5.1 Hypersensitivity Reactions

Hypersensitivity reactions, including rash, pruritus, drug hypersensitivity, and urticaria, were reported with AJOVY in clinical trials. Most reactions were mild to moderate, but some led to discontinuation or required corticosteroid treatment. Most reactions were reported from within hours to one month after administration.

If a hypersensitivity reaction occurs, consider discontinuing AJOVY, and institute appropriate therapy.

6 ADVERSE REACTIONS

The following clinically significant adverse reactions are discussed in greater detail in other sections of the labeling:

- Hypersensitivity Reactions [see *Warnings and Precautions (5.1)*]

6.1 Clinical Trials Experience

Because clinical trials are conducted under widely varying conditions, adverse reaction rates observed in the clinical trials of a drug cannot be directly compared to rates in the clinical trials of another drug, and may not reflect the rates observed in clinical practice. The safety of AJOVY was evaluated in 2512 patients with migraine who received at least 1 dose of AJOVY, representing 1279 patient-years of exposure. Of these, 1730 patients were exposed to AJOVY 225 mg monthly or AJOVY 675 mg quarterly for at least 6 months, 775 patients for at least 12 months, and 138 patients for at least 15 months. In placebo-controlled clinical trials (Studies 1 and 2), 662 patients received AJOVY 225 mg monthly for 12 weeks (with or without a loading dose of 675 mg), and 663 patients received AJOVY 675 mg quarterly for 12 weeks [see *Clinical Studies (14)*]. In the controlled trials, 87% of patients were female, 80% were White, and the mean age was 41 years.

The most common adverse reactions in the clinical trials for the preventive treatment of migraine (incidence at least 5% and greater than placebo) were injection site reactions. The adverse reactions that most commonly led to discontinuations were injection site reactions (1%). Table 1 summarizes adverse reactions reported in the 3-month placebo-controlled studies (Study 1 and Study 2), and the 1-month follow-up period after those studies.

Table 1: Adverse Reactions Occurring with an Incidence of At Least 2% for Either Dosing Regimen of AJOVY and At Least 2% Greater Than Placebo in Studies 1 and 2

Adverse Reaction	AJOVY 225 mg Monthly (n=290) %	AJOVY 675 mg Quarterly (n=667) %	Placebo Monthly (n=668) %
Injection site reactions ^a	43	45	38

^a Injection site reactions include multiple related adverse event terms, such as injection site pain, induration, and erythema.

injection 6.2 Immunogenicity

As with all therapeutic proteins, there is a potential for immunogenicity. The detection of antibody formation is highly dependent on sensitivity and specificity of the assay. Additionally, the observed incidence of antibody (including neutralizing antibody) positivity in an assay may be influenced by several factors, including assay methodology, sample handling, timing of sample collection, concomitant medications, and underlying disease. For these reasons, comparison of the incidence of antibodies to fremanezumab-vfrm in the studies described below with the incidence of antibodies in other studies to other products may be misleading. Clinical immunogenicity of AJOVY was monitored by analyzing anti-drug antibodies (ADA) and neutralizing antibodies in drug-treated patients. The data reflect the percentage of patients whose test results were positive for antibodies to AJOVY in specific assays.

In 3-month placebo-controlled studies, treatment-emergent ADA responses were observed in 6 out of 1701 (0.4%) AJOVY-treated patients. One of the 6 patients developed anti-AJOVY neutralizing antibodies at Day 84. In the ongoing long-term open-label study, ADA were detected in 1.6% of patients (30 out of 1888). Out of 30 ADA-positive patients, 17 had a neutralizing activity in their post-dose samples. Although these data do not demonstrate an impact of anti-fremanezumab-vfrm antibody development on the efficacy or safety of AJOVY in these patients, the available data are too limited to make definitive conclusions.

8 USE IN SPECIFIC**POPULATIONS 8.1 Pregnancy****Risk Summary**

There are no adequate data on the developmental risk associated with the use of AJOVY in pregnant women. AJOVY has a long half-life [see *Clinical Pharmacology* (12.3)]. This should be taken into consideration for women who are pregnant or plan to become pregnant while using AJOVY. Administration of fremanezumab-vfrm to rats and rabbits during the period of organogenesis or to rats throughout pregnancy and lactation at doses resulting in plasma levels greater than those expected clinically did not result in adverse effects on development [see *Animal Data*]. In the U.S. general population, the estimated background risk of major birth defects and miscarriage in clinically recognized pregnancies is 2-4% and 15-20%, respectively. The estimated rate of major birth defects (2.2-2.9%) and miscarriage (17%) among deliveries to women with migraine are similar to rates reported in women without migraine.

Clinical Considerations**Disease-Associated Maternal and/or Embryo/Fetal Risk**

Published data have suggested that women with migraine may be at increased risk of preeclampsia during pregnancy.

Data Animal Data

When fremanezumab-vfrm (0, 50, 100, or 200 mg/kg) was administered to male and female rats by weekly subcutaneous injection prior to and during mating and continuing in females throughout organogenesis, no adverse embryofetal effects were observed. The highest dose tested was associated with plasma exposures (AUC) approximately 2 times that in humans at a dose of 675 mg.

Administration of fremanezumab-vfrm (0, 10, 50, or 100 mg/kg) weekly by subcutaneous injection to pregnant rabbits throughout the period of organogenesis produced no adverse effects on embryofetal development. The highest dose tested was associated with plasma AUC approximately 3 times that in humans (675 mg).

Administration of fremanezumab-vfrm (0, 50, 100, or 200 mg/kg) weekly by subcutaneous injection to female rats throughout pregnancy and lactation resulted in no adverse effects on pre- and postnatal development. The highest dose tested was associated with plasma AUC approximately 2 times that in humans (675 mg).

8.2 Lactation**Risk Summary**

There are no data on the presence of fremanezumab-vfrm in human milk, the effects on the breastfed infant, or the effects on milk production. The developmental and health benefits of breastfeeding should be considered along with the mother's clinical need for AJOVY and any potential adverse effects on the breastfed infant from AJOVY or from the underlying maternal condition.

8.4 Pediatric Use

Safety and effectiveness in pediatric patients have not been established.

8.5 Geriatric Use

Clinical studies of AJOVY did not include sufficient numbers of subjects aged 65 and over to determine whether they respond differently from younger subjects.

11 DESCRIPTION

Fremanezumab-vfrm is a fully humanized IgG2Da/kappa monoclonal antibody specific for calcitonin gene-related peptide (CGRP) ligand. Fremanezumab-vfrm is produced by recombinant DNA technology in Chinese hamster ovary (CHO) cells. The antibody consists of 1324 amino acids and has a molecular weight of approximately 148 kDa.

AJOVY (fremanezumab-vfrm) injection is a sterile, preservative-free, clear to opalescent, colorless to slightly yellow solution for subcutaneous injection, supplied in a single-dose 225 mg/1.5 mL prefilled syringe.

Each prefilled syringe delivers 1.5 mL of solution containing 225 mg fremanezumab-vfrm, disodium ethylenediaminetetraacetic acid dihydrate (EDTA) (0.204 mg), L-histidine (0.815 mg), L-histidine hydrochloride monohydrate (3.93 mg), polysorbate-80 (0.3 mg), sucrose (99 mg), and Water for Injection, and has a pH of 5.5.

12 CLINICAL PHARMACOLOGY**12.1 Mechanism of Action**

Fremanezumab-vfrm is a humanized monoclonal antibody that binds to calcitonin gene-related peptide (CGRP) ligand and blocks its binding to the receptor.

injection 12.2 Pharmacodynamics

The relationship between the pharmacodynamic activity and the mechanism(s) by which fremanezumab-vfrm exerts its clinical effects is unknown.

12.3 Pharmacokinetics**Absorption**

After single subcutaneous (SC) administrations of 225 mg, 675 mg, and 900 mg fremanezumab-vfrm, median time to maximum concentrations (t_{max}) was 5 to 7 days. Dose-proportionality, based on population PK, was observed between 225 mg to 900 mg. Steady state was achieved by approximately 168 days (about 6 months) following 225 mg SC monthly and 675 mg SC quarterly dosing regimens. Median accumulation ratio, based on once-monthly and once-quarterly dosing regimens, is approximately 2.3 and 1.2, respectively.

Distribution

Fremanezumab-vfrm has an apparent volume of distribution of approximately 6 liters, suggesting minimal distribution to the extravascular tissues.

Metabolism

Similar to other monoclonal antibodies, fremanezumab-vfrm is degraded by enzymatic proteolysis into small peptides and amino acids.

Elimination

Fremanezumab-vfrm apparent clearance was approximately 0.141 L/day. Fremanezumab-vfrm was estimated to have a half-life of approximately 31 days.

Specific Populations

A population PK analysis assessing effects of age, race, sex, and weight was conducted on data from 2287 subjects. No dose adjustments are recommended for AJOVY. **Patients with Hepatic or Renal Impairment** Hepatic/renal impairment is not expected to affect the pharmacokinetics of fremanezumab. A population PK analysis of integrated data from the AJOVY clinical studies did not reveal a difference in the pharmacokinetics of fremanezumab in patients with mild hepatic impairment, relative to those with normal hepatic function. There were only 4 patients with moderate hepatic impairment, and no patient with severe hepatic impairment in fremanezumab clinical studies. No dedicated hepatic/renal impairment studies were conducted to assess the effect of hepatic or renal impairment on the pharmacokinetics of fremanezumab.

Drug Interactions

Fremanezumab is not metabolized by cytochrome P450 enzymes; therefore, interactions with concomitant medications that are substrates, inducers, or inhibitors of cytochrome P450 enzymes are unlikely. Additionally, the effects of medications for the acute treatment (specifically analgesics, ergots, and triptans) and preventive treatment of migraine were evaluated in a population PK model, and found not to influence fremanezumab exposure.

13 NONCLINICAL TOXICOLOGY**13.1 Carcinogenesis, Mutagenesis, Impairment of****Fertility Carcinogenesis**

Carcinogenicity studies of fremanezumab-vfrm were not conducted.

Mutagenesis

Genetic toxicology studies of fremanezumab-vfrm were not conducted. **Impairment of Fertility**

When fremanezumab-vfrm (0, 50, 100, or 200 mg/kg) was administered to male and female rats by weekly subcutaneous injection prior to and during mating and continuing in females throughout organogenesis, no adverse effects on male or female fertility were observed. The highest dose tested was associated with plasma exposures (AUC) approximately 2 times that in humans at a dose of 675 mg.

14 CLINICAL STUDIES

The efficacy of AJOVY was evaluated as a preventive treatment of episodic or chronic migraine in two multicenter, randomized, 3-month, double-blind, placebo-controlled studies (Study 1 and Study 2, respectively).

Episodic Migraine

Study 1 (NCT 02629861) included adults with a history of episodic migraine (patients with <15 headache days per month). All patients were randomized (1:1:1) to receive subcutaneous injections of either AJOVY 675 mg every three months (quarterly), AJOVY 225 mg monthly, or placebo monthly, over a 3-month treatment period. Patients were allowed to use acute headache treatments during the study. A subset of patients (21%) was allowed to use one additional concomitant preventive medication.

The study excluded patients with a history of significant cardiovascular disease, vascular ischemia, or thrombotic events, such as cerebrovascular accident, transient ischemic attacks, deep vein thrombosis, or pulmonary embolism.

The primary efficacy endpoint was the mean change from baseline in the monthly average number of migraine days during the 3-month treatment period. Secondary endpoints included the proportion of patients reaching at least a 50% reduction in monthly average number of migraine days during the 3-month treatment period, the mean change from baseline in the monthly average number of days of use of any acute headache medication during the 3-month treatment period, and the mean change from baseline in the number of migraine days during the first month of the treatment period.

In Study 1, a total of 875 patients (742 females, 133 males), ranging in age from 18 to 70 years, were randomized. A total of 791 patients completed the 3-month double-blind phase. The mean migraine frequency at baseline was approximately 9 migraine days per month, and was similar across treatment groups.

Both monthly and quarterly dosing regimens of AJOVY demonstrated statistically significant improvements for efficacy endpoints compared to placebo over the 3-month period, as summarized in Table 2.

Table 2: Efficacy Endpoints in Study 1

Study 1 Efficacy Endpoint	AJOVY 225 mg Monthly (N=287)	AJOVY 675 mg Quarterly (N=288)	Placebo (N=290)
Monthly migraine days (MMD)			
Baseline migraine days	8.9	9.2	9.1
Change from baseline	-3.7	-3.4	-2.2
Difference from placebo	-1.5	-1.2	
p-value	<0.001	<0.001	
≥50% MDD responders			
% responders	47.7%	44.4%	27.9%
Difference from placebo	19.8%	16.5%	
p-value	<0.001	<0.001	
Monthly acute headache medication days			
Change from baseline	-3.0	-2.9	-1.6
Difference from placebo	-1.4	-1.3	
p-value	<0.001	<0.001	

Figure 1 displays the mean change from baseline in the average monthly number of migraine days in Study 1.

Figure 1: Change from Baseline in Monthly Migraine Days in Study 1^a

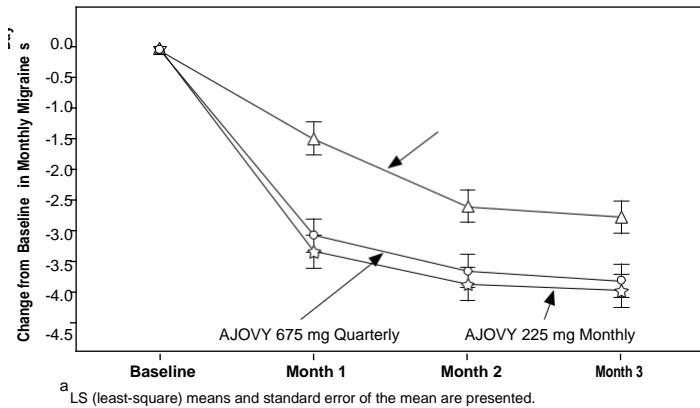

^a LS (least-square) means and standard error of the mean are presented.

Figure 2 shows the distribution of change from baseline in mean monthly migraine days in bins of 2 days by treatment group in Study 1. A treatment benefit over placebo for both doses of AJOVY is seen across a range of changes from baseline in monthly migraine days.

Figure 2: Distribution of Change from Baseline in Mean Monthly Migraine Days by Treatment Group in Study 1

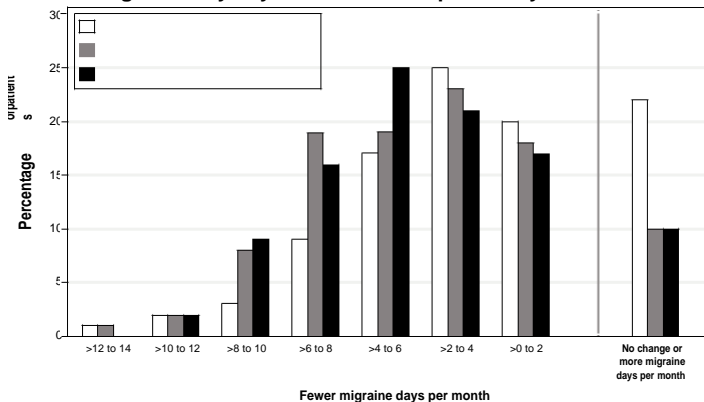

Chronic Migraine

Study 2 (NCT 02621931) included adults with a history of chronic migraine (patients with ≥15 headache days per month). All patients were randomized (1:1:1) to receive subcutaneous injections of either AJOVY 675 mg starting dose followed by 225 mg monthly, 675 mg every 3 months (quarterly), or placebo monthly, over a 3-month treatment period. Patients were allowed to use acute headache treatments during the study. A subset of patients (21%) was allowed to use one additional concomitant, preventive medication.

The study excluded patients with a history of significant cardiovascular disease, vascular ischemia, or thrombotic events, such as cerebrovascular accident, transient ischemic attacks, deep vein thrombosis, or pulmonary embolism.

The primary efficacy endpoint was the mean change from baseline in the monthly average number of headache days of at least moderate severity during the 3-month treatment period. The secondary endpoints were the mean change from baseline in the monthly average number of migraine days during the 3-month treatment period, the proportion of patients reaching at least 50% reduction in the monthly average number of headache days of at least moderate severity during the 3-month treatment period, the mean change from baseline in the monthly average number of days of use of any acute headache medication during the 3-month treatment period, and the mean change from baseline in the number of headache days of at least moderate severity during the first month of treatment.

In Study 2, a total of 1130 patients (991 females, 139 males), ranging in age from 18 to 70 years, were randomized. A total of 1034 patients completed the 3-month double-blind phase.

Both monthly and quarterly dosing regimens of AJOVY treatment demonstrated statistically significant improvement for key efficacy outcomes compared to placebo, as summarized in Table 3.

Table 3: Efficacy Endpoints in Study 2

Study 2 Efficacy Endpoint	AJOVY 225 mg Monthly (N=375)	AJOVY 675 mg Quarterly (N=375)	Placebo (N=371)
Baseline headache days of any severity ^b	20.3	20.4	20.3
Baseline headache days of at least moderate severity ^c	12.8	13.2	13.3
Change from baseline in the monthly average number of headache days of at least moderate severity	-4.6	-4.3	-2.5
Difference from placebo	-2.1	-1.8	
p-value	<0.001	<0.001	
Change from baseline in the monthly average number of migraine days in patients	-5.0	-4.9	-3.2
Change from baseline in monthly average number of headache days of at least moderate severity at 4 weeks after 1 st dose	-4.6	-4.6	-2.3
Percentage of patients with ≥ 50% reduction in monthly average number of headache days of at least moderate severity	40.8%	37.6%	18.1%
Change from baseline in monthly average number of days of acute headache medication	-4.2	-3.7	-1.9

^a In Study 2, patients received a 675 mg starting dose.

^b Used for chronic migraine diagnosis.

^c Used for primary endpoint analysis.

Figure 3 displays the mean change from baseline in the average monthly number of headache days of at least moderate severity in Study 2.

Figure 3: Change from Baseline in Monthly Headache Days of At Least Moderate Severity in Study 2^a

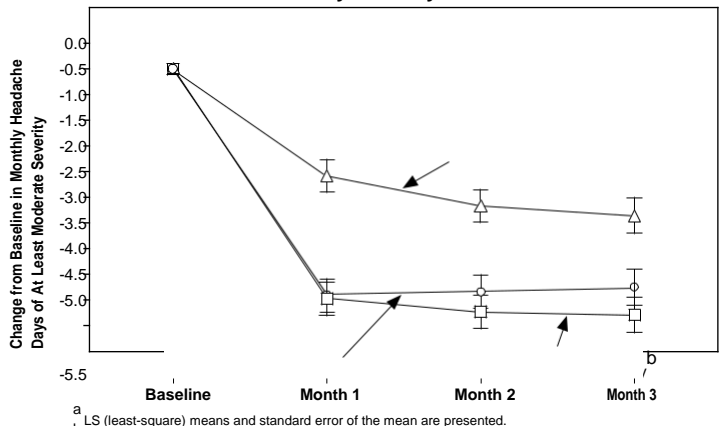

^a LS (least-square) means and standard error of the mean are presented.

^b In Study 2, patients received a 675 mg starting dose.

Figure 4 shows the distribution of change from baseline in monthly headache days of at least moderate severity at month 3 in bins of 3 days by treatment group. A treatment benefit over placebo for both dosing regimens of AJOVY is seen across a range of changes from baseline in headache days.

Figure 4: Distribution of Mean Change from Baseline in Monthly Headache Days of At Least Moderate Severity by Treatment Group in Study 2

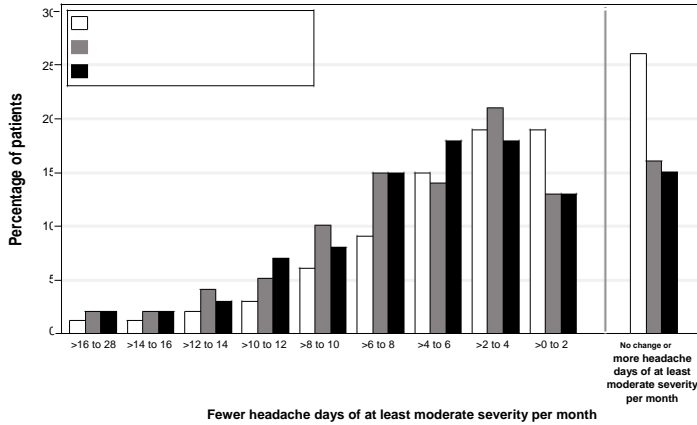

*In Study 2, patients received a 675 mg starting dose.

16 HOW SUPPLIED/STORAGE AND HANDLING 16.1 How Supplied

AJOVY (fremanezumab-vfrm) injection is a sterile, preservative-free, clear to opalescent, colorless to slightly yellow solution for subcutaneous administration. The prefilled syringe cap is not made with natural rubber latex. AJOVY is supplied as follows:

- NDC 51759-204-10: carton of one 225 mg/1.5 mL single-dose prefilled syringe

16.2 Storage and Handling

- Store refrigerated at 2°C to 8°C (36°F to 46°F) in the original outer carton to protect from light.
- If necessary, AJOVY may be kept in the original carton at room temperature up to 25°C (77°F) for a maximum of 24 hours. After removal from the refrigerator, AJOVY must be used within 24 hours or discarded.
- Do not freeze.
- Do not expose to extreme heat or direct sunlight.
- Do not shake.

17 PATIENT COUNSELING INFORMATION

Advise the patient and/or caregiver to read the FDA-approved patient labeling (Patient Information and Instructions for Use).

Information on Preparation and Administration

Provide guidance to patients and caregivers on proper subcutaneous administration technique, including aseptic technique, and how to use the single-dose prefilled syringe [see Dosage and Administration (2.2)]. Instruct patients and/or caregivers to read and follow the Instructions for Use each time they use AJOVY.

Instruct patients prescribed the regimen of 675 mg every 3 months to administer the dosage as three consecutive subcutaneous injections of 225 mg each [see Dosage and Administration (2.1)].

Hypersensitivity Reactions

Inform patients about the signs and symptoms of hypersensitivity reactions and that these reactions can occur up to 1 month after administration. Advise patients to contact their healthcare provider immediately if signs or symptoms of hypersensitivity reactions occur [see Warnings and Precautions (5.1)].

Manufactured by:

Teva Pharmaceuticals USA, Inc.
North Wales, PA 19454
US License No. 2016

AJOVY® (fremanezumab-vfrm), its use, or its process of manufacture, may be protected by one or more United States patents, including US 8,007,794, US 8,586,045 and US 9,896,502.

©2019 Teva Pharmaceuticals USA, Inc.

AJO-002

**Patient Information
AJOVY® (a-JO-vee)
(fremanezumab-vfrm) injection
for subcutaneous use**

What is AJOVY?

AJOVY is a prescription medicine used for the preventive treatment of migraine in adults.

It is not known if AJOVY is safe and effective in

children. **Who should not use AJOVY?**

Do not use AJOVY if you are allergic to fremanezumab-vfrm or any of the ingredients in AJOVY. See the end of this leaflet for a complete list of the ingredients in AJOVY.

Before you use AJOVY, tell your healthcare provider if you:

- are pregnant or plan to become pregnant. It is not known if AJOVY will harm your unborn baby.
- are breastfeeding or plan to breastfeed. It is not known if AJOVY passes into your breast milk. Talk to your healthcare provider about the best way to feed your baby while using AJOVY.

Tell your healthcare provider about all the medicines you take, including prescription and over-the-counter medicines, vitamins, and herbal supplements.

Know the medicines you take. Keep a list of your medicines with you to show your healthcare provider and pharmacist when you get a new medicine.

How should I use AJOVY?

- See the detailed “Instructions for Use” for information on how to prepare and inject a dose of AJOVY.
- Use AJOVY exactly as your healthcare provider tells you to use it.
- AJOVY is given by injection under your skin (subcutaneously).
- Your healthcare provider should show you or your caregiver how to prepare and inject your dose of AJOVY before you or your caregiver give your AJOVY the first time.
- Your healthcare provider will tell you how much AJOVY to use and when to use it.
 - Your healthcare provider will tell you if you should use AJOVY 225 mg one time every month or AJOVY 675 mg one time every 3 months.
 - If your prescribed dose is AJOVY 675 mg every 3 months, you must use 3 separate syringes. You will give 3 separate injections one time every 3 months.
- If you are giving 3 injections of AJOVY for your prescribed dose, you may use the same body site for all 3 injections, but not the same spot.
- **Do not** inject AJOVY in the same injection site that you inject other medicine.
- If you are switching from using AJOVY one time every month to one time every 3 months or if you are switching from using AJOVY one time every 3 months to one time every month, give the first dose of AJOVY on the day it was due to be given on your old schedule.
- If you miss a dose of AJOVY, take it as soon as possible. If you need to take the dose late, you will need to adjust your schedule: if you take 225 mg of AJOVY, inject your next dose 1 month after the late dose. If you take 675 mg of AJOVY, inject your next dose 3 months after the late dose. If you have questions about your schedule, ask your healthcare provider.

continued

AJOVY® (fremanezumab-vfrm) injection

What are the possible side effects of AJOVY?

AJOVY may cause serious side effects, including:

- **Allergic reactions.** Allergic reactions, including itching, rash, and hives, can happen within hours and up to 1 month after receiving AJOVY. Call your healthcare provider or get emergency medical help right away if you have any of the following symptoms of an allergic reaction:
 - swelling of your face, mouth, tongue, or throat
 - trouble breathing

The most common side effects of AJOVY include:

- injection site reactions

Tell your healthcare provider if you have any side effect that bothers you or that does not go away.

These are not all the possible side effects of AJOVY. For more information, ask your healthcare provider or pharmacist.

Call your doctor for medical advice about side effects. You may report side effects to FDA at 1-800-FDA-1088.

How should I store AJOVY?

- Store AJOVY in the refrigerator between 36°F to 46°F (2°C to 8°C).
- Keep AJOVY in the carton it comes in to protect from light.
- If needed, AJOVY may be stored at room temperature between 68°F to 77°F (20°C to 25°C) in the carton it comes in for up to 24 hours. Do not use AJOVY if it has been out of the refrigerator for 24 hours or longer. Dispose of (throw away) AJOVY in a sharps disposal container if it has been out of the refrigerator for 24 hours or longer.
- **Do not** freeze. If AJOVY freezes, throw it away in a sharps disposal container.
- Keep AJOVY out of extreme heat and direct sunlight.
- **Do not** shake AJOVY.

Keep AJOVY prefilled syringe out of the reach of small children.

General information about the safe and effective use of

AJOVY. Medicines are sometimes prescribed for purposes other than those listed in a Patient Information leaflet. Do not use AJOVY for a condition for which it was not prescribed. Do not give AJOVY to other people, even if they have the same symptoms that you have. It may harm them. You can ask your pharmacist or healthcare provider for information about AJOVY that is written for health professionals.

What are the ingredients in AJOVY?

Active ingredient: fremanezumab-vfrm

Inactive ingredients: disodium ethylenediaminetetraacetic acid dihydrate (EDTA), L-histidine, L-histidine hydrochloride monohydrate, polysorbate-80, sucrose, and Water for Injection. The prefilled syringe cap is not made with natural rubber latex.

Manufactured by: Teva Pharmaceuticals USA, Inc., North Wales, PA 19454
US License No. 2016
AJOPL-002

For more information, go to www.AJOVY.com or call 1-888-483-8279.

This Patient Information has been approved by the U.S. Food and Drug Administration.

Revised: 1/2019

AJOVY® (fremanezumab-vfrm) injection

Instructions for Use AJOVY® (a-JO-vee) (fremanezumab-vfrm) injection for subcutaneous use

For subcutaneous injection only.

Read and follow the **Instructions for Use** for your AJOVY prefilled syringe before you start using it and each time you get a refill.

Important:

- AJOVY prefilled syringe is for single-time (one-time) use only. Put AJOVY in a FDA-cleared sharps disposal container right away after use. Do not throw away (dispose of) your used sharps disposal container in your household trash.
- Before injecting, let AJOVY sit at room temperature for 30 minutes.
- Keep AJOVY prefilled syringe out of the reach of small children.
- After you remove the needle cap from AJOVY, to prevent infection, **do not** touch the needle.
- **Do not** pull back on the plunger at any time, as this can break the prefilled syringe.
- **Do not** inject AJOVY in your veins (intravenously).
- **Do not** re-use your AJOVY prefilled syringe, as this could cause injury or infection.
- **Do not** share your AJOVY prefilled syringe with another person. You may give another person an infection or get an infection from them.

You may give AJOVY yourself. If you feel uncomfortable, you should not get your first dose of AJOVY until you or your caregiver receive training from a healthcare provider on the right way to use AJOVY.

Storage Conditions:

- Store AJOVY in the refrigerator between 36°F to 46°F (2°C to 8°C).
- Keep AJOVY in the carton it comes in to protect from light.
- If needed, AJOVY may be stored at room temperature between 68°F to 77°F (20°C to 25°C) in the carton it comes in for up to 24 hours. Do not use AJOVY if it has been out of the refrigerator for 24 hours or longer. Dispose of (throw away) AJOVY in a sharps disposal container if it has been out of the refrigerator for 24 hours or longer.
- **Do not** freeze. If AJOVY freezes, throw it away in a sharps disposal container.
- Keep AJOVY out of extreme heat and direct sunlight.
- **Do not** shake AJOVY.

AJOVY prefilled syringe (Before use). See Figure A.

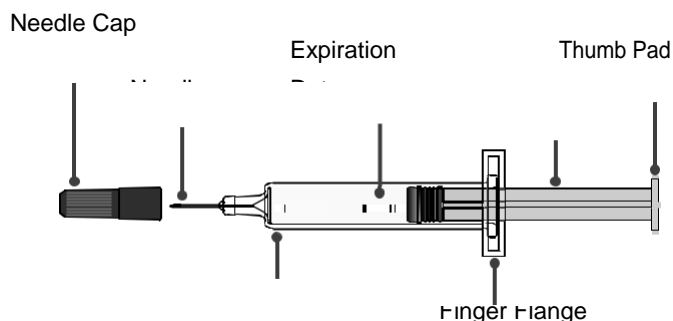

Figure A

AJOVY prefilled syringe (After use). See Figure B.



Figure B

How do I inject AJOVY?



Read this before you inject.

Step 1. Check your prescription.

AJOVY comes as a single-dose (1 time) prefilled syringe. Your healthcare provider will prescribe the dose that is best for you.

- If your healthcare provider prescribes the 225 mg monthly dose for you, take 1 injection monthly, using a prefilled syringe.
- If your healthcare provider prescribes the 675 mg every 3 months dose for you, take 3 separate injections one after another, using a different prefilled syringe for each injection. You will take these injections once every 3 months.

Before you inject, always check the label of your single-dose prefilled syringe to make sure you have the correct medicine and the correct dose of AJOVY. If you are not sure of your dose, ask your healthcare provider.

Step 2. Remove the prefilled syringe from the carton.

- You may need to use more than 1 prefilled syringe based on your prescribed dose.
- **Hold** the prefilled syringe (as shown in Figure C).
- **Remove** the syringe from the carton.
- **Do not** shake the prefilled syringe at any time, as this could affect the way the medicine works.

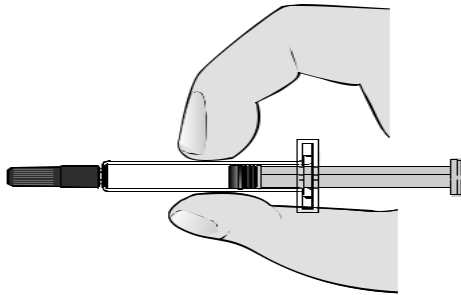

Figure C

Step 3. Gather the supplies you will need to inject AJOVY.

- **Gather** the following supplies (see Figure D) and the number of AJOVY 225 mg prefilled syringes you will need to give your prescribed dose:
 - If your dose is 225 mg, you will need 1 AJOVY 225 mg prefilled syringe.
 - If your dose is 675 mg, you will need 3 AJOVY 225 mg prefilled syringes.
 - alcohol swabs (not supplied).
 - gauze pads or cotton balls (not supplied).

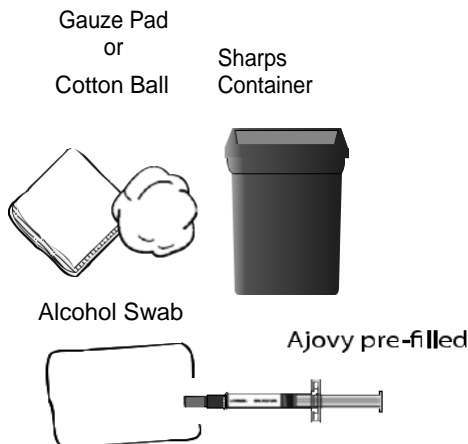
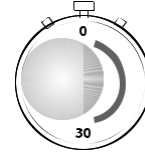

Figure D

Tell your pharmacist or healthcare provider if you do not already have a sharps or puncture-resistant container.

Step 4. Let AJOVY reach room temperature.

- **Place** the supplies you have gathered on a clean, flat surface.
- **Wait** for 30 minutes to allow the medicine to reach room temperature.
- **Do not** leave the prefilled syringe in direct sunlight, as this could damage the liquid medicine.
- **Do not** warm up the AJOVY prefilled syringe using hot water, a microwave, or any other way than instructed, as this could damage the liquid medicine.



Step 5. Wash your hands.

- **Wash your hands** with soap and water and dry well with a clean towel. Be careful not to touch your face or hair after washing your hands.

Step 6. Look closely at your AJOVY prefilled syringe.

Note: You may see air bubbles in the prefilled syringe. This is normal. **Do not** remove the air bubbles from the prefilled syringe before giving your injection. Injecting AJOVY with these air bubbles will not harm you.

- **Check that the liquid medicine in the prefilled syringe is clear and colorless to slightly yellow before you give your injection** (see Figure E). If the liquid has any particles in it, or is discolored, cloudy, or frozen, do not use the prefilled syringe. Call your healthcare provider or pharmacist.
- **Check** that AJOVY appears on the prefilled syringe.
- **Check** the expiration date printed on the prefilled syringe label.
- **Do not** use the prefilled syringe if it has any visible damage, such as cracks or leaks. See disposal instructions in Step 12.
- **Do not** use if you have been given the wrong medicine.
- **Do not** use the prefilled syringe if the expiration date has passed.

The above checks are all important to make sure the medicine is safe to use.

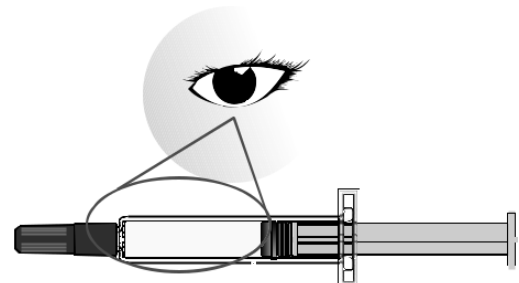

Figure E

Step 7. Choose your injection area.

- **Choose** an injection area from the following areas (see Figure F):
 - your **stomach area** (abdomen), avoid about 2 inches around the belly button.
 - the **front of your thighs**, an area that is at least 2 inches above the knee and 2 inches below the groin.
 - the **back of your upper arms**, in the fleshy area of the upper back portion.

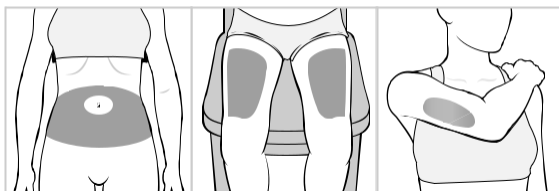

Figure F

Note: There are some injection areas on your body that are hard to reach (like the back of your arm). You may need help from someone who has been instructed on how to give your injection if you cannot reach certain injection areas.

Step 8. Clean your injection area.

- **Clean** the chosen injection area using a new alcohol swab.
- **Wait** 10 seconds to allow the skin to dry before injecting.
- **Do not** inject AJOVY into an area that is tender, red, bruised, callused, tattooed, hard, or that has scars or stretch marks.
- **Do not** inject AJOVY in the same injection site that you inject other medicine.
- If you want to use the same body site for the three separate injections needed for the 675 mg dose, make sure the second and third injections are not at the same spot you used for the other injections.

Step 9. Remove needle cap and do not replace.

- **Pick up** the body of the prefilled syringe with 1 hand.
- **Pull** the needle cap **straight off** with your other hand (see Figure G). **Do not twist.**
- **Throw away** the needle cap right away.
- **Do not** put the needle cap back on the prefilled syringe, to avoid injury and infection.

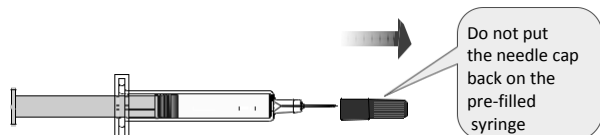

Figure G

Step 10. Give your injection following the 4 steps below.

<p>1. Use your free hand to gently pinch up at least 1 inch of the skin that you have cleaned.</p>	<p>2. Insert the needle into the pinched skin at a 45 to 90 degree angle.</p>	<p>3. When the needle is all the way into your skin, use your thumb to push the plunger.</p>	<p>4. Push the plunger slowly all the way down as far as it will go to inject all of the medicine.</p>

Step 11. Remove the needle from your skin.

- After you have injected all of the medicine, **pull the needle straight out** (see Figure H).
- **Do not** recap the needle at any time to avoid injury and infection.



Figure H

Step 12. Apply pressure at the injection site.

- Use a clean, dry cotton ball or gauze to **gently press on the injection site** for a few seconds.
- **Do not** rub the injection site
- **Do not** re-use the prefilled syringe.

Step 13. Dispose of your prefilled syringe right away.



- Put your used prefilled syringes, needles, and sharps in a FDA-cleared sharps disposal container right away after use.
- **Do not throw away (dispose of) loose needles, syringes, or prefilled syringes in your household trash. Do not recycle your used sharps disposal container.**
- If you do not have a FDA-cleared sharps disposal container, you may use a household container that is:
 - made of a heavy-duty plastic,
 - can be closed with a tight-fitting, puncture-resistant lid, without sharps being able to come out,
 - upright and stable during use,
 - leak-resistant, and
 - properly labeled to warn of hazardous waste inside the container.
- When your sharps disposal container is almost full, you will need to follow your community guidelines for the right way to dispose of your sharps disposal container. There may be state or local laws about how you should throw away used syringes. For more information about safe sharps disposal, and for specific information about sharps disposal in the state that you live in, go to the FDA's website at: <http://www.fda.gov/safesharpsdisposal>
- **Do not** dispose of your used sharps disposal container in your household trash unless your community guidelines permit this. **Do not** recycle your used sharps disposal container.

Injection Complete

This Instructions for Use has been approved by the U.S. Food and Drug Administration.

Manufactured by:
 Teva Pharmaceuticals USA, Inc.
 North Wales, PA 19454
 US License No. 2016

©2019 Teva Pharmaceuticals USA, Inc.



AJOIFU-002
 Revised: 1/2019
 FRE-41405

