

An Estimation Method of State of Charge and Lifetime for Lead-Acid Batteries in Smart Grid Scenario

Danny Montenegro	Simón Rodríguez	Javier Revelo Fuelagán	John Barco Jiménez
Universidad de Nariño	Universidad de Nariño	Universidad de Nariño	Universidad de Nariño
Departamento de Electrónica	Departamento de Electrónica	Departamento de Electrónica	Departamento de Electrónica
San Juan de Pasto, Colombia	San Juan de Pasto, Colombia	San Juan de Pasto, Colombia	San Juan de Pasto, Colombia
danny.m92@hotmail.com	leaosir@hotmail.com	javierrevelof@gmail.com	johnbarco@gmail.com

Abstract—This work presents mathematical model of batteries AGM lead acid type that form part of a photovoltaic generating system. The proposed model allows estimation of the voltage of the battery and the state of charge with the objective of designing a controller to create greater duration, efficiency and autonomy of the system. Additionally, we present a mathematical model to estimate the useful life of the battery degraded due to corrosion, cycle, and the state of charge that permits evaluation of the loss of storage capacity in a general distribution scenario. Finally, experimental results and simulations obtained from the monitoring of a bank of batteries in a photovoltaic system are analyzed to validate the proposed model of state of charge. Furthermore, we will present the results of the evaluation of the useful life of the battery in two case studies in the framework of smart grid considering the functioning of a photovoltaic generator under different configurations.

Index Terms—Battery AGM Lead-Acid, State of Charge, Battery Voltage, Degradación, Photovoltaic System, Smart Grid.

I. INTRODUCTION

TODAY the study of smart grids is of great importance because of the problems which exist concerning the generation of power due to the lack of fossil fuels, the low energy efficiency environmental pollution among others [1]. These problems have motivated the generation of electrical energy through renewable sources such as solar energy, eolic energy, biomass, wave energy among others, that together constitute generating sources distributed in smart grids. It should result in these generating systems are formed in

modules which convert the energy from the primary source into electrical energy. The photovoltaic systems, in particular, are made of: a) solar panels, b) charge controllers, c) investor or conditioner of power through electrical convertors, and d) the stage of energy conditioning of which the last is the major concern because it reduces the useful life of the battery. Taking this into account, the present investigation is focused on the study of the storage system of the photovoltaic system configured from a bank of AGM batteries, lead acid type, which supplies the required demand for the charge [1].

The control of the elements of an smart grid is highly important and requires continuous supervision of all the components, especially the batteries [2]. To have adequate control of the batteries indispensable it is necessary to understand the behavior of the principal variables, in such a way that it is possible to establish the algorithms of the charge and discharge to take the best advantage of the energy available. Therefore, this document proposes a simulation model that estimates the value of the principal variables such as: the voltage in the terminals, the state of charge (SOC), the depth of discharge (DOD), and a model to determine the degradation of this kind of batteries. With this data we can establish of the criteria of a control design adequate for the storage state in this way achieve longer useful life of the batteries of the photovoltaic system.

This work studied different methods and model to estimate battery state of charge and degradation. Between the following are highlighted: estimation by extended Kalman filter [3], by composed basic circuits RC [4], by measure of open circuit voltage [3], by measure circuits of internal impedance [5], stress model to determine lifetime [6] and by the current

This work has been supported by ALTERNAR Project, BPIN 2013000100089, Acuerdo 005, OCAD-Fondo CTeI, SGR, Colombia.

D. Montenegro, S. Rodríguez, J. Barco y J. Revelo are with the research group in electrical and electronics engineering - GIIEE - Department of Electronic Engineering, University of Nariño, San Juan de Pasto, Colombia. E-mails: {danny.m92, leaosir}@hotmail.com, {johnbarco, javierrevelof}@gmail.com

integral method which it is taken as basis for the development of this work.

This document is organized in the following way. In Section II we present the proposed model to estimate the state of charge of the battery and the model of degradation. Then, in Section III the state of charge model is validated with experimental results and the results are shown of the simulation of the model of degradation. Finally, in Section IV we present the conclusions and the future work of development.

II. PROPOSED MODEL TO ESTIMATE THE SOC AND DEGRADATION MODEL

A. Model for the estimation of the SOC

There is a great variety of proposed models to determine the principal characteristics of the different battery technologies, principally of the lead acid type [1], [7] and ion-lithium [8], [9], among the models that are highlighted: Model of Thevenin, single layer and double layer [3], [1], Copetti and Chenlo model [10], models of third and fourth order [11], [12] and models focused on circuitual direct current [7], [13], [4].

Because of the complexity of the interpretive models, this research proposes a theoretical model to characterize the battery AGM type lead-acid [2], [14], as shown in Fig. 1. The model is formed for a source of volts $V_{oc}(t)$ which represents the voltage of the open circuit of the battery and the internal resistance R_{int} . This model is selected because it allows for rapid characterization of the battery, because it only requires the basic parameters such as nominal values obtained from the data sheet.

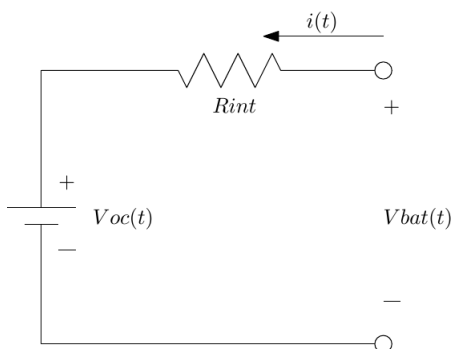

Fig. 1. Circuitual Diagram of the Theoretical Model

This model neglects the effect of the ambient temperature having a constant value of 25°C around the components of the battery, and is considered uniquely the stage of charge and discharge [15]. To determine the $SOC(t)$, we use the most common method of the integration of the current [3], [16], but this model is considered to have parameters expressed in $[Wh]$

[15], which makes it necessary to relate the voltage $V_{oc}(t)$ with the current $i(t)$, therefore the equation of the $SOC(t)$ is expressed thus:

$$SOC(t) = SOC_o + \frac{1}{SOC_m} \int_0^t \frac{i(\tau) \cdot V_{oc}(\tau)}{3600} d\tau \quad (1)$$

where: SOC_o is the initial state of charge of the battery [%] and SOC_m is the maximum energy of the battery $[Wh]$, which is obtained by the multiplication of the capacity of the battery and the nominal voltage [8]: $SOC_m[Wh] = V_{nom}[V] \cdot C_{nom}[Ah]$.

To determine the voltage of the open circuit $V_{oc}(t)$ take into account two stages: charge and discharge of the battery, where the constants expressed in the equations have taken [15].

a) *Stage of Charge*: For this stage the expression is:

$$V_{oc}(t) = (2 + 0.148 \cdot \beta)ns \quad , \quad \beta = \frac{SOC}{SOC_m} \quad (2)$$

where: ns is the number of the cells of the battery and SOC is the state of energy of the battery $[Wh]$.

b) *Stage of Discharge*: The voltage of the open circuit is given as:

$$V_{oc}(t) = (1.926 + 0.124 \cdot \beta)ns \quad (3)$$

For its part, the proposed model has a unique expression of independent internal resistance to the stage where the battery finds itself [15].

$$R_{int} = \frac{\left(0.7 + \left(\frac{0.1}{|SOC_o - 0.2|}\right)\right)}{SOC_m} \cdot ns \quad (4)$$

The value is constant and depends on parameters of the battery and its desired characteristics (SOC_o and SOC_m).

With the earlier variables, the voltage of the battery is determined $V_{bat}(t)$ that is expressed by the equation (5).

$$V_{bat}(t) = V_{oc}(t) + R_{int} \cdot i(t) \quad (5)$$

Furthermore, the depth of the discharge, $DOD(t)$, represents the quantity of the energy extracted from the battery and is determined from the $SOC(t)$ [3], like this: $DOD(t) = 1 - SOC(t)$.

B. Model of degradation by performance of amp-hours

The performance model of amp-hours (Ah-throughput) is based on the supposition that the cycle of charge/discharge to determined amp-hours has an impact on the useful life of the battery which depends on the conditions in which the cycle is made. Put another way, it assumes the normal conditions in which a battery can make all the cycles established by the manufacturer reaching a performance in amp-hours (Ah) specific until the end of the battery's useful life. However, the change of the functioning conditions can result in a virtual increase or decrease of the cycle of function. In this form the useful life of the battery is measured as the number of

TABLE II
STUDY BATTERY MT122050

Parameter	Value
Nominal Voltage	12 V
Nominal Capacity	205 Ah
Temperature	25 °C
Max. Charge Current	60 A
Max Discharge Current	1500 A

current values are entered into the proposed model jointly with an initial state of charge $SOC_o = 0.96$, to validate the model. The results of $V_{bat}(t)$ and $SOC(t)$ are presented in Fig. 4 and Fig. 5 respectively.

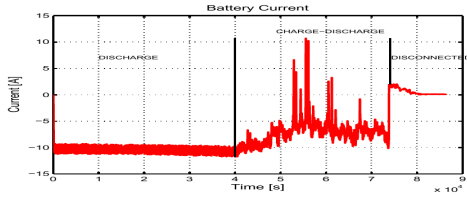

Fig. 3. Current Charge-Discharge of the First Case Study

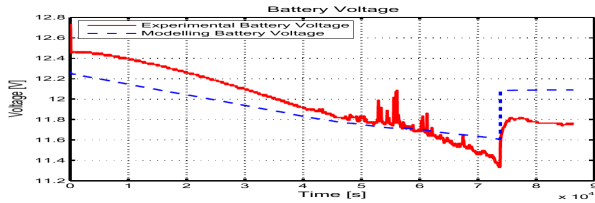

Fig. 4. Battery Voltage from the First Case Study

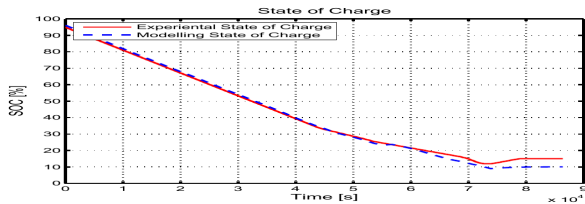

Fig. 5. State of Charge in the First Case Study

2 Case : In this case study the configuration of charge and discharge is between 100% and 70% for $SOC(t)$ with an initial state of charge $SOC_o = 0.97$. In this case the system is submitted to a discharge $i(t)$ of 10A for two hours, a recharge with energy from the panels for four hours and finally two additional hours of discharge at 10A; this gives results for the profile of current for the battery in Fig. 6. The results of the simulation and experiments are shown in Fig. 7 and Fig. 8.

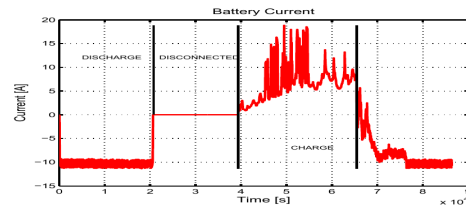

Fig. 6. Current of Charge-Discharge in the Second Case Study

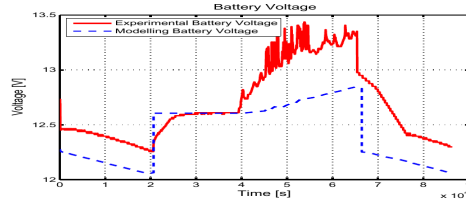

Fig. 7. Voltage of the Battery in the Second Case Study

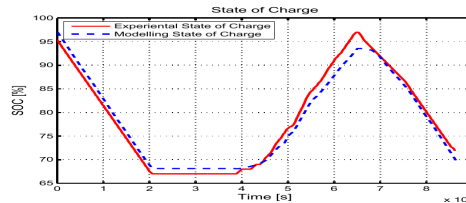

Fig. 8. State of Charge in the Second Case Study

Additionally, we present the evaluation of the useful life of the storage system in the previous cases. The estimation of the useful life is made by calculating the loss of storage capacity implied in each regime of charge-discharge, assuming that these cycles are repeated daily. In the first case, in Fig. 9 it can be seen that after 48 months of functioning the capacity is reduced to under 80% coming to an end of the useful life. In the second case, we can observe in Fig. 10, that the system gets an additional period of 12 months compared to the first coming to an end of the useful life after 60 months of functioning.

These results must principally be the state of charge in the first case the average SOC maintained at 50%, while in the second case the SOC is maintained at approximately 85%, the result is a major degradation for the system in the first case study, since the lead-acid batteries it is recommended to maintain the SOC at high values to avoid sulfation and later corrosion of the electrodes.

Although the model shows very interesting and consistent results according to the literature reviewed. It is possible make improvements such as the inclusion of other variables such as temperature, average state of charge and others working conditions which vary according to the site location of the system. In

the same way the model should be tested under the interaction with components based on renewable energy systems, given the interest of the subject and achieve a robust model capable of performing a correct estimation to the different behaviors that can arise.

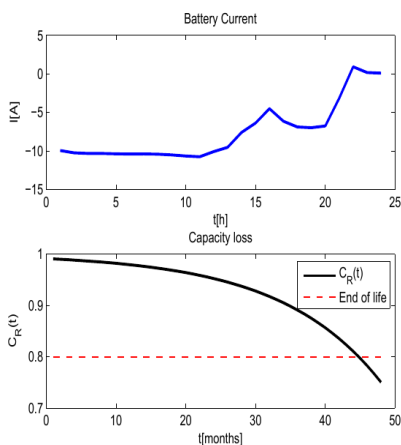

Fig. 9. Loss of Capacity for the First Case Study

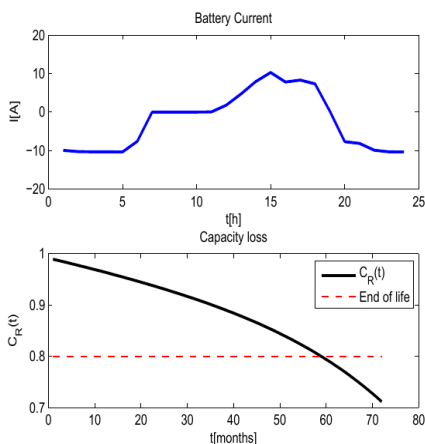

Fig. 10. Loss of Capacity for the Second Case Study

IV. CONCLUSIONS AND FUTURE WORK

The proposed model of AGM type lead-acid batteries for the estimation of SOC needs uniquely named parameters of manufacture to fit the real behavior of the batteries. Furthermore, the model of degradation represents an important tool to evaluate the impact which could have a specific configuration of control of charge-discharge for the battery, in this way it is possible to analyze various case studies in the framework of smart grids and choose the configuration of control which allows the best performance with respect to the

use of energy of the battery and its useful life.

The resulting model can be included in a power management system battery for charge/discharge planning in order to maximize its lifetime.

The model is interesting because it is defined by some parameters found in the literature for lead-acid technology, this relatively simple way for the simulation of any battery technology. However, it would be interesting to validate this model by means of experimental results, in several case studies of smart grids.

The simplicity of the model to estimate the useful life allows this to be included in the objective function as a problem of optimizing conditions for the charge-discharge of the energy of the battery, considering the different charges and generators distributed as part of a smart grid. Finally, with the data obtained in this manner from future work, the design of an optimal controller for battery charge will be completed with objective of improving the useful life of the storage system.

REFERENCES

- [1] A. Severino, *Modelación de Generador Fotovoltaico y Banco de Baterías de Plomo-Ácido como Elementos de una Microred*. Santiago de Chile: Universidad de Chile, 2011.
- [2] D. Guasch, "Modelado y análisis de sistemas fotovoltaicos," Tesis de Doctorado, Universitat Politècnica de Catalunya, 2003.
- [3] D. Burgos, "Estimación del estado de carga para un banco de baterías basada en modelación difusa y filtro extendido de kalman," Master's thesis, Universidad de Chile, 2013.
- [4] S. Sato and A. Kawamura, "A New Estimation Method of State of Charge using Terminal Voltage and Internal Resistance for Lead Acid Battery," *Yokohama National University, Department of Electrical and Computer Engineering*, pp. 565–570, 2002.
- [5] D. Ferrer, *Circuito para la Medición de la Carga y la Salud de Baterías*. Universitat Politècnica de Catalunya, 2011.
- [6] R. Langella, A. Testa, and C. Ventre, "A New Model of Lead-Acid Batteries Lifetime in Smart Grid Scenario," *ENERGYCON*, pp. 1343–1348, May, 2014.
- [7] O. Tremblay and L.-A. Dessaint, "Experimental Validation of a Battery Dynamic Model for EV Applications," *World Electric Vehicle Journal*, vol. 3, May, 2009.
- [8] R. Iglesias, A. Lago, A. Nogueiras, C. Martínez-Peñalver, J. Marcos, C. Quintans, M. Moure, and M. Valdés, "Modelado y Simulación de una Batería de Ion-Litio Comercial Multicelda," *Universidad de Vigo, Departamento de Tecnología Electrónica*.
- [9] M. Chen and G. A. Rincón-Mora, "Accurate Electrical Battery Model Capable of Predicting Runtime and I²V Performance," *IEEE Transactions on Energy Conversion*, vol. 21, no. 2, pp. 504–511, Jun. 2006.
- [10] J. Copetti and F. Chenlo, "Lead/acid batteries for photovoltaic applications. Test results and modelling," *Journal of Power Sources*, vol. 47, pp. 109–118, 1994.
- [11] S. Barsali and M. Ceraolo, "Dynamical Models of Lead-Acid Batteries: Implementation Issues," *IEEE Transactions on Energy Conversion*, vol. 17, no. 1, pp. 16–23, Mar. 2002.
- [12] S. Waheed, "Modeling and simulation of lead-acid storage batteries within photovoltaic power systems," Master's thesis, An-Najah National University, 2012.

- [13] M. Soltani and S. M. T. Bathaee, "A New Dynamic Model Considering Effects of Temperature, Pressure and Internal Resistance for PEM Fuel Cell Power Modules," *DRPT2008 6-9 April 2008 Nanjing China*, pp. 2757–2762, Apr. 2008.
- [14] D. Guasch and S. Silvestre, "Dynamic Battery Model for Photovoltaic Applications," *Progress in Photovoltaics: Research and Applications*, no. 11, p. 193–206, 2003.
- [15] H. Fernández, A. Martínez I., V. Guzmán A., and M. I. Giménez, "Modelaje y Simulación de una Batería de Plomo-Ácido Mediante Fuentes Dependientes de Voltaje-Corriente y Bloques de Funciones Aritméticas," *UNEXPO, Universidad Ciencia y Tecnología*, vol. 9, no. 33, Mar. 2005.
- [16] M. Gholizadeh and F. R. Salmasi, "Estimation of State of Charge, Unknown Nonlinearities, and State of Health of a Lithium-Ion Battery Based on a Comprehensive Unobservable Model," *IEEE Transactions on Industrial Electronics*, vol. 61, no. 3, pp. 1335–1344, Mar. 2014.
- [17] R. Dufo-López, J. M. Lujano-Rojas, and J. L. Bernal-Agustín, "Comparison of different lead-acid battery lifetime prediction models for use in simulation of stand-alone photovoltaic systems," *Applied Energy*, vol. 115, no. 0, pp. 242 – 253, 2014. [Online]. Available: <http://www.sciencedirect.com/science/article/pii/S0306261913009148>
- [18] H. Bindner, T. Cronin, P. Lundsager, J. F. Manwell, U. Abdulwahid, and I. Baring-Gould, "Lifetime modelling of lead acid batteries," Risø National Laboratory, Roskilde, Denmark, Tech. Rep., 2005.
- [19] J. Barco and N. Quijano, "Routing and scheduling of recharge for electric vehicles," in *Virtual Control Conference on Smart Grid Modeling and Control (VCC-13)*, Sept. 2013.
- [20] MTEK. Hoja de características - batería mt122050. [Online]. Available: www.mtek-sa.com