

The right way to attach almost anything to metal roofs!

S-5!®

The Right Way!

S-5-U Clamp

The S-5-U clamp is by far our most popular and most versatile clamp. It fits about 85% of the standing seam profiles manufactured in North America—including most structural and architectural profiles. It can be used on vertically oriented seams and, by rotating the clamp 90 degrees, it can also be used on most horizontal 2" seam profiles.

Its simple design, generous dimensioning and multiple hole orientations are what make the S-5-U clamp so versatile for use with the S-5!® snow retention products, such as ColorGard®, as well as with other heavy-duty applications.

Installation is as simple as setting the specially patented round-point setscrews into the clamp, placing the clamp on the seam, and tightening them to the specified tension. Then, affix ancillary items using the bolt provided with the product. Go to www.S-5.com/tools for information and tools available for properly attaching and tensioning S-5! clamps.

S-5-U Mini Clamp

The S-5-U Mini is a bit shorter than the S-5-U and has one setscrew rather than two. The Mini is the choice for attaching all kinds of rooftop accessories: signs, walkways, satellite dishes, antennas, rooftop lighting, lightning protection systems, solar arrays, exhaust stack bracing, conduit, condensate lines, mechanical equipment—just about anything!*

*S-5! Mini clamps can be used with RamGard® unitized snow guards. They are not compatible with, and should not be used with, S-5! SnoRail™/SnoFence™ or ColorGard® snow retention systems.

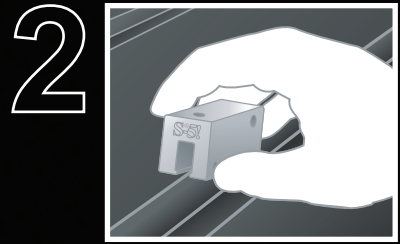
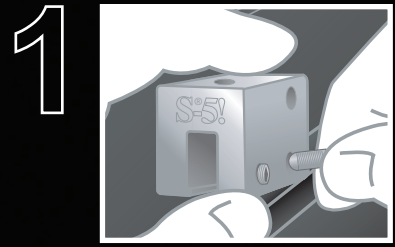

The S-5-U clamp is our most popular and versatile clamp, fitting about 85% of the standing seam profiles in North America.

S-5-U and S-5-U Mini

888-825-3432 | www.S-5.com

S-5![®]

The Right Way!

The strength of the S-5-U clamp is in its simple design. The patented setscrews will slightly dimple the metal seam material but not pierce it—leaving roof warranties intact.

The **S-5-U** and **S-5-U Mini clamps** are each furnished with the hardware shown to the right. Each box also includes a bit tip for tightening setscrews using an electric screw gun. A structural aluminum attachment clamp, the S-5-U is compatible with most common metal roofing materials excluding copper. All included hardware is stainless steel. Please visit www.S-5.com for more information including CAD details, metallurgical compatibilities and specifications.

The S-5-U clamp has been tested for load-to-failure results on most major brands and profiles of standing seam roofing. The independent lab test data found at www.S-5.com can be used for load-critical designs and applications. S-5![®] holding strength is unmatched in the industry.

Example Profiles

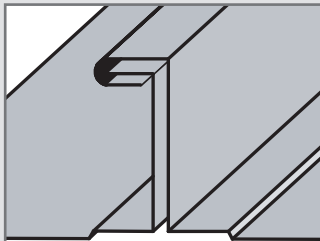

For horizontal seams under 0.65" do not use this clamp. Visit www.S-5.com for more detailed information and proper clamp to use.

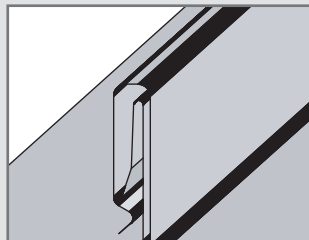
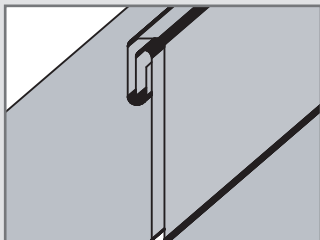

S-5-U Clamp

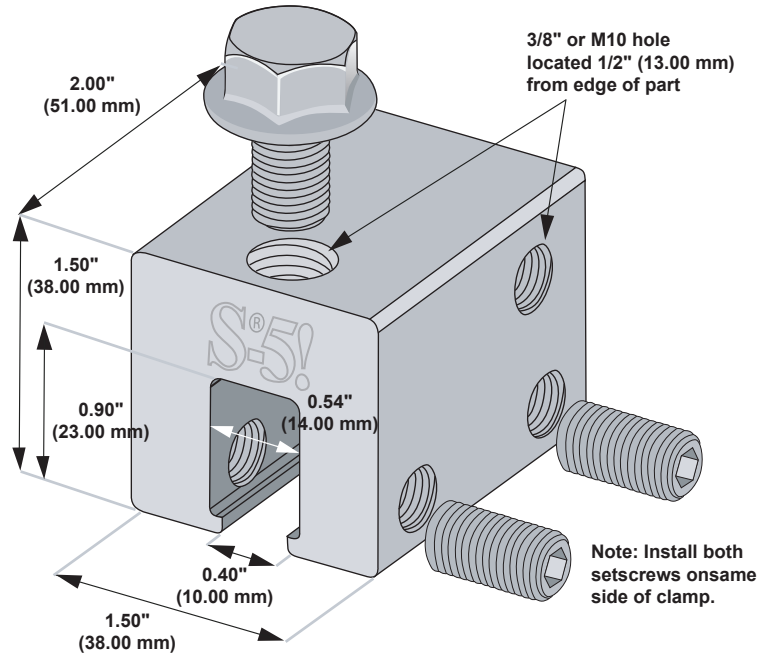

S-5-U Mini Clamp

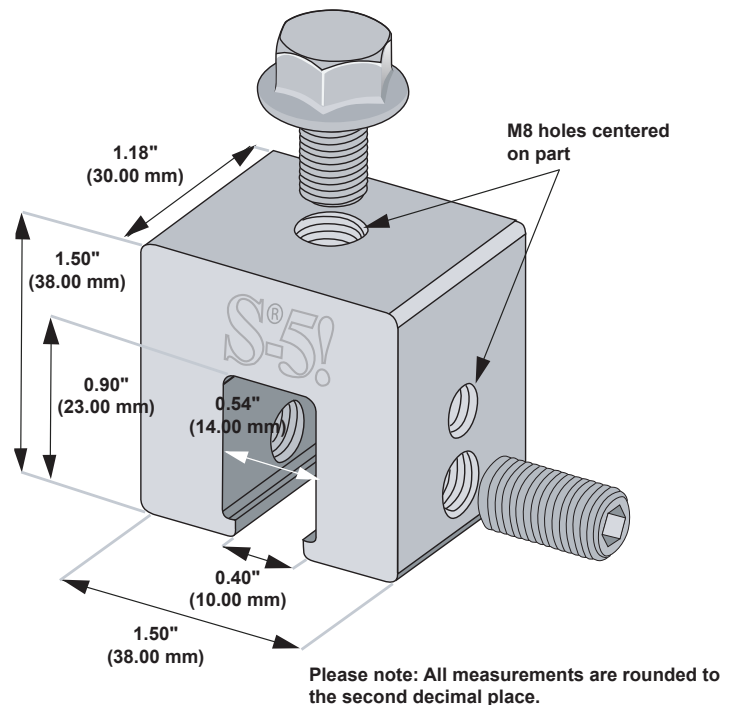

S-5![®] Warning! Please use this product responsibly!

Products are protected by multiple U.S. and foreign patents. Visit the website at www.S-5.com for complete information on patents and trademarks. For maximum holding strength, setscrews should be tensioned and re-tensioned as the seam material compresses. Clamp setscrew tension should be verified using a calibrated torque wrench between 160 and 180 inch pounds when used on 22ga steel, and between 130 and 150 inch pounds for all other metals and thinner gauges of steel. Consult the S-5! website at www.S-5.com for published data regarding holding strength.

Copyright 2012, Metal Roof Innovations, Ltd. S-5! products are patented protected. S-5! aggressively protects its patents, trademarks and copyrights.

Distributed by

For product and purchase inquiries contact:

ecodirect

CLEAN ENERGY SOLUTIONS

www.ecodirect.com