

Features:

- Universal AC input with active PFC
- Compatible with Lead Acid, Li-ion, Gel and AGM batteries
- Support optional remote controller (CR-1)
- Voltage / temperature compensation with battery temp. sensor (Optional)
- 2-stage fan speed control
- Dry contact for alarm
- High efficiency and high reliability
- Built-in battery rescue function
- Built-in Engine Start Battery (ESB) output function
- Protection: Short Circuit / Over Voltage / Over Temperature / Brown-out
- Withstand 2G vibration test
- RS-232 communication interface
- Output power OK signal



MODEL		CX1215	CX1225	CX1235	CX1250	CX1280
Output	Battery Type	Lead Acid / Li-ion / Gel / AGM				
	Standard Boost Charge Voltage	14.4V / 14.7V (Select by S1-1)				
	Standard Float Charge Voltage	13.8V / 13.5V (Select by S1-2)				
	Main Rated Current	15A	25A	35A	50A	80A
	Current Range	0 ~ 15A	0 ~ 25A	0 ~ 35A	0 ~ 50A	0 ~ 80A
	Main Output	1	2	2	3	3
	ESB Output	1	1	1	—	—
	ESB Output Voltage / Current	13.8V / 2A	13.8V / 2A	13.8V / 2A	—	—
	Battery Charging Mode	3 - stage charging capability (IUOU)				
Single Output Current Limit	15A	25A	35A	40A	40A	
Input	Voltage Range	90 ~ 264VAC				
	Power Factor (Typ.)	PF > 0.92 at full load				
	Frequency Range	47 ~ 63Hz				
	Efficiency (Typ.) at 230VAC	87%	87%	87%	87%	87%
	AC Current (Typ.)	2.5 A / 100VAC 1.07A / 240VAC	4.1 A / 100VAC 1.8A / 240VAC	6.2 A / 100VAC 2.8A / 240VAC	8.24 A / 100VAC 3.6A / 240VAC	13.3 A / 100VAC 5.4A / 240VAC
Protection	Leakage Current	For earth < 1mA / 240VAC				
	Short Circuit	Current is reduced to < 1A continued 30sec. , fan will operate 30 seconds then turn off				
	Over Voltage	17.5V ±1%, Protection type: Shut down output (recovery after resetting AC power on)				
	Over Temperature	Charger Over Temperature 100 ±5°C detected by heat sink Battery Over Temperature 52 ±5°C (Optional device - COTEK temperature sensor), connect on CN3 Protection type: Auto recovery after heat sink temperature goes down to 50°C				
Function	Alarm Signal	NC. / NO. Relay contact output (Please refer to page 5 Alarms Signal & Fan Control)				
	Power Mode	Supply 13.2V Current limit output voltage				
	Temperature Compensation	-10mV / 0.5°C with COTEK temperature sensor				
	Charging Sleep Mode	Note.4 By Remote Controller and S1-4 DIP switch (Please refer to page 4~5)				
	Remote Controller	Note.5 Support COTEK Remote Controller CR-1 setting Function (CN3 or CN4)				
Environment	Working Temp.	-20 ~ 50°C (refer to output load de-rating curve)				
	Working Humidity	20 ~ 90% RH non-condensing				
	Storage Temp., Humidity	-40 ~ +85°C, 20 ~ 90% RH				
	Temp. Coefficient	±0.03% (0 ~ 50°C)				
	Vibration	10 ~ 500Hz, 2G 10min. / 1cycle period for 60min. each along X, Y, Z axes				
Safety & EMC	Safety Standards	Certified EN 60335-1, EN 60335-2-29				
	Withstand Voltage	I/P-O/P: 4242VDC, I/P-FG: 1768VDC, O/P-FG: 700VDC				
	Isolation Resistance	I/P-O/P: 100M Ohms / 500VDC				
	EMI Conduction & Radiation	EN 55022; EN 55024; EN 61204-3; EN 55014-1; EN 55014-2				
	Harmonic Current	EN 61000-3-2; EN 61000-3-3; EN61204-3; EN 61000-6-1; EN 61000-6-3				
	EMS Immunity	IEC 61000-4-2, 3, 4, 5, 6, 8, 11; ENV 50204				
Others	Dimension (WxHxD)	183x72x243.4mm	183x72x243.4mm	183x72x263.4mm	213x76.5x272.4mm	213x76.5x312.4mm
	Packing	1.6kg	1.7kg	1.9kg	3.1kg	4.0kg
Note	<p>1. All parameters not specially mentioned are measured at 230VAC input, rated load and 25°C of ambient temperature.</p> <p>2. The charger is considered a component which will be installed into a final equipment. The final equipment must be re-confirmed that it still meets EMC directives.</p> <p>3. Before charging, make sure the battery charger and battery specifications are compatible.</p> <p>4. When use sleep mode, please refer to charging current v.s. heat sink temperature de-rating curve.</p> <p>5. Optional Remote Controller (CR-1).</p>					

Mechanical Specification:

Unit : mm[inch]

MODEL: CX1215/1225/1235

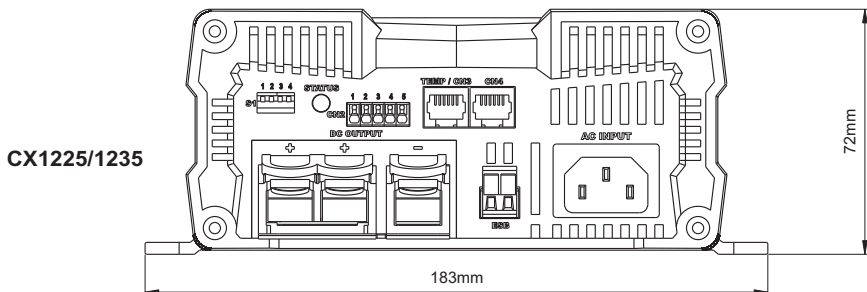
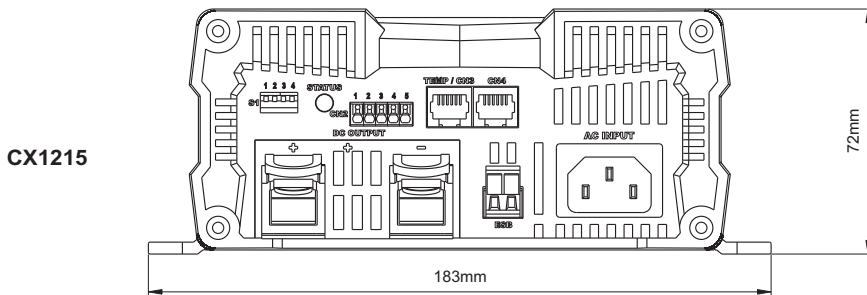
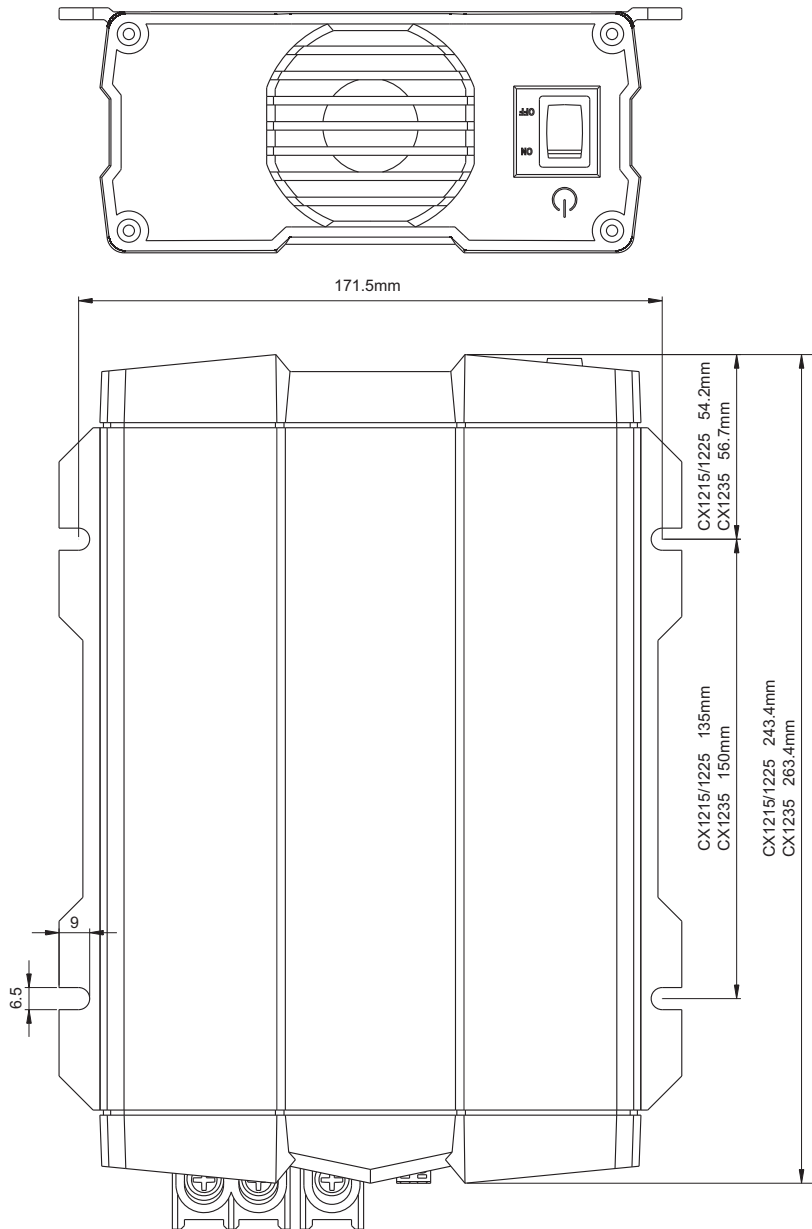

Unit : mm[inch]

MODEL: CX1250/1280

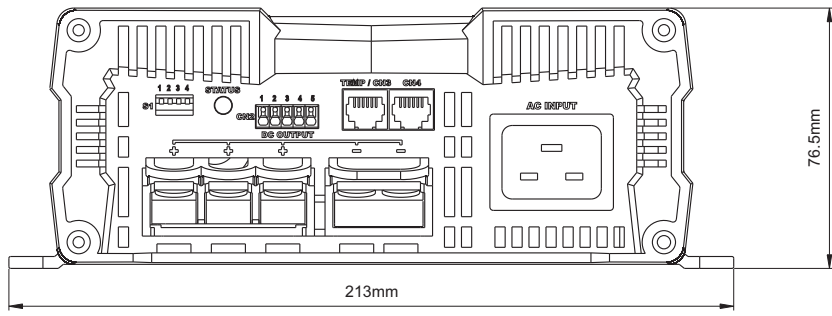
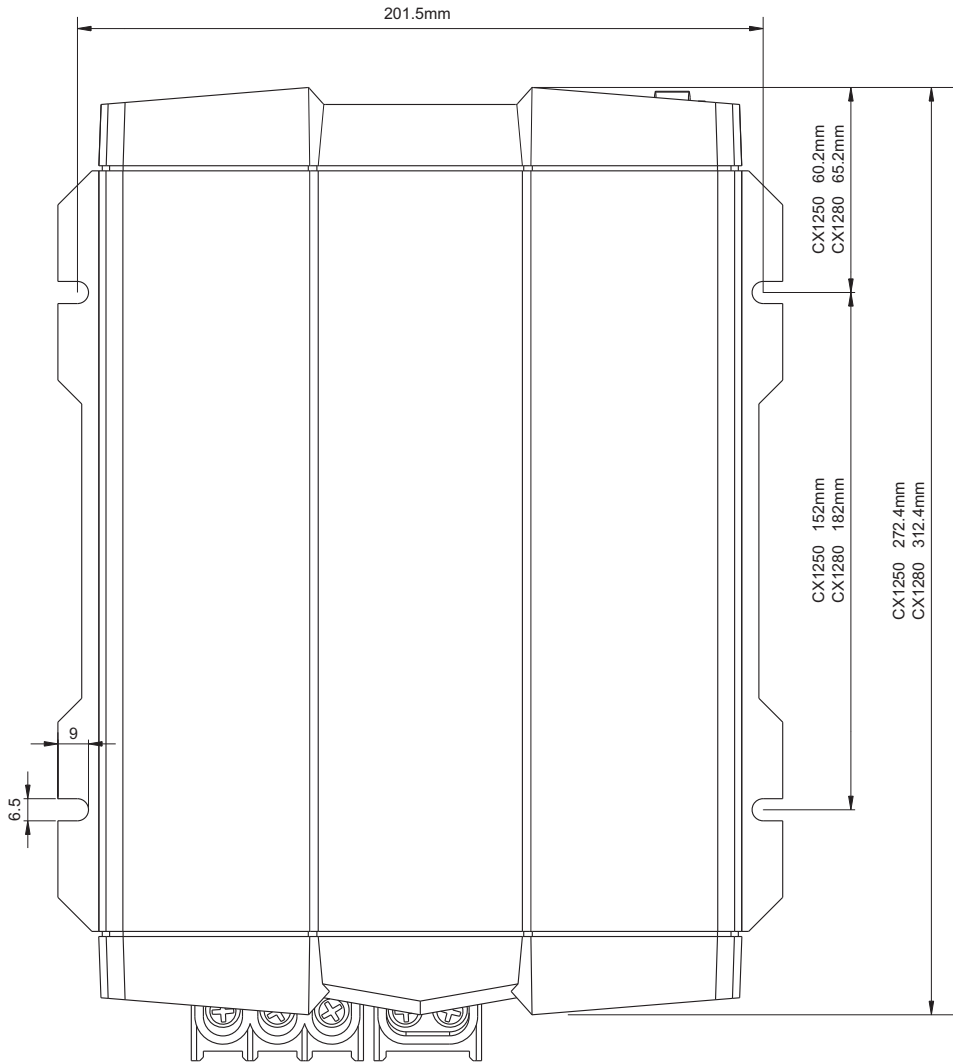
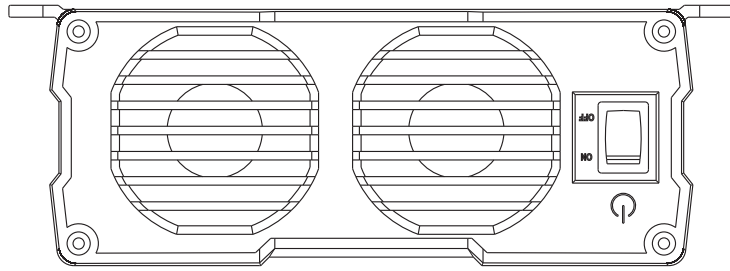

Charging Mode Setting (S1):

Status	1	2	3	4	CC/CV	Float	Notes
CC turn to CV voltage	ON	X	OFF	X	14.4V	—	1. Without COTEK temperature sensor: No voltage and temperature compensation (20°C) 2. With COTEK temperature sensor: Output voltage changes per temperature changes (-10mV/0.5°C)
	OFF	X	OFF	X	14.7V	—	
Float voltage	X	ON	OFF	X	—	13.5V	
	X	OFF	OFF	X	—	13.8V	
Power Mode (Current limit output voltage)	OFF	OFF	ON	X	13.2V	13.2V	No voltage, current and temperature compensation (Regulated by internal SENSOR)
	OFF	ON	ON	X			
	ON	OFF	ON	X			
REMOTE	ON	ON	ON	X	—	—	Charger ON/OFF (Press the button for 3 second to turn off the charger) & Sleep mode ON/OFF (Once the charger is turned on, press the button for 1 second to activate sleep mode)
Sleep mode ON / OFF	X	X	X	ON	—	—	Limit the maximum fan speed (Output current is regulated by the temperature)
	X	X	X	OFF	—	—	Don't limit the maximum fan speed (Output current is regulated by the temperature)

X: Not applicable
---: Not applicable

Charging Status and Indicator:

Charging status	LED Status		Alternation in the charging Status	Default setting	
Bulk-1	Orange fast	Charging voltage >10.2V and < float voltage		
Bulk-2	Orange slow	- - - - -	1.Charging voltage > Float voltage and charging current >= Rating current	--	6 hours
			2.Charging voltage = CV voltage and charging current < Rating current	2 minutes	
Absorption-1	Orange solid	—————	Charging current > 6% of rated current (±1%)	6 hours	
Absorption-2	Green solid	—————	Charging current < 6% of rated current (±1%)	8 hours	
Float	Green flash	1.Charging voltage >12.8V	288 hours	Unlimited circle
	LED colour change by the status change		2. The voltage goes up to CV voltage to charge the battery once every 288 hours	85 minutes	
Float to Bulk-1	--		Charging voltage < 12.8V	30 sec.	

Failure Indicator:

Failure status	LED Status		Description	Activate	Recovery
Input or Output	Red solid	—————	Current is reduced to <1A ,Continued 30 sec., FAN turn on 30 sec then turn off.	Output <1V	AC Reset, Output>9V
			AC I/P unstable	<85V,>270V	>90V,<264V
			Output FUSE blown	Voltage difference >0.5V,>0.1 sec.	AC Reset
Temperature	Red fast	Battery over heat (the indicator available when COTEK temperature sensor connected only)	>52°C	<45°C
			Battery in cold condition(the indicator is available when COTEK temp. sensor is connected)	<-18°C	>-10°C
			Charger over heat (Heat Sink)	>100°C	<50°C
Battery Voltage	Red slow	- - - - -	Battery over voltage	>17.5V	AC Reset , <15.7V
			Battery under voltage or output under voltage in CC mode.	<10.2V	>10.5V
Fan Abnormality	Red light flash twice	- -	Fan abnormality	-----	-----
ESB Failure	Red light slow ones	ESB no output / output short	<1V & 30 sec.	AC Reset

TEMP/CN3

1	R_VCC
2	GND
3	TEMP
4	BAT-
5	DATA I/O
6	BAT+

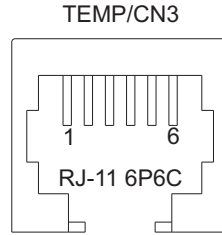

CN4:

1	R_VCC
2	BAT-
3	NC.
4	BAT-
5	DATA I/O
6	BAT+

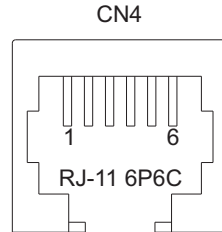

ESB Connectors:

+	VCC
-	GND

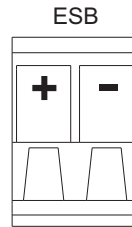

Alarms Signal and Fan Control Connectors Pin Definition(CN2):

1	Normally Closed
2	Normally Open
3	COM
4	Sleep Mode Control
5	GND

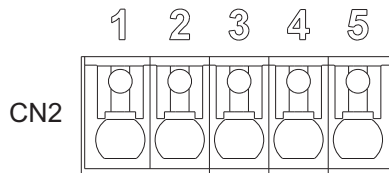

4-5 SHORT	Sleep Mode ON
4-5 OPEN	Sleep Mode OFF

Charging Curve at Temperature Compensation:

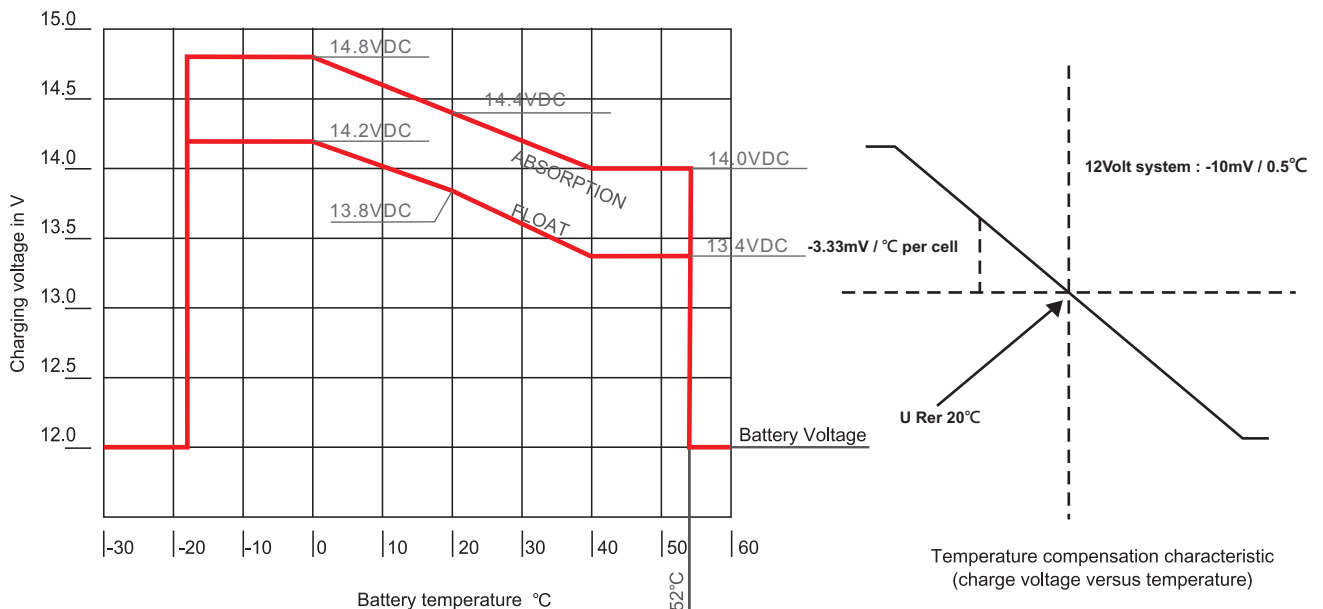

※ In the CV=14.4V and float =13.8V situation. Please follow this rule in other situation.

Charging curve:

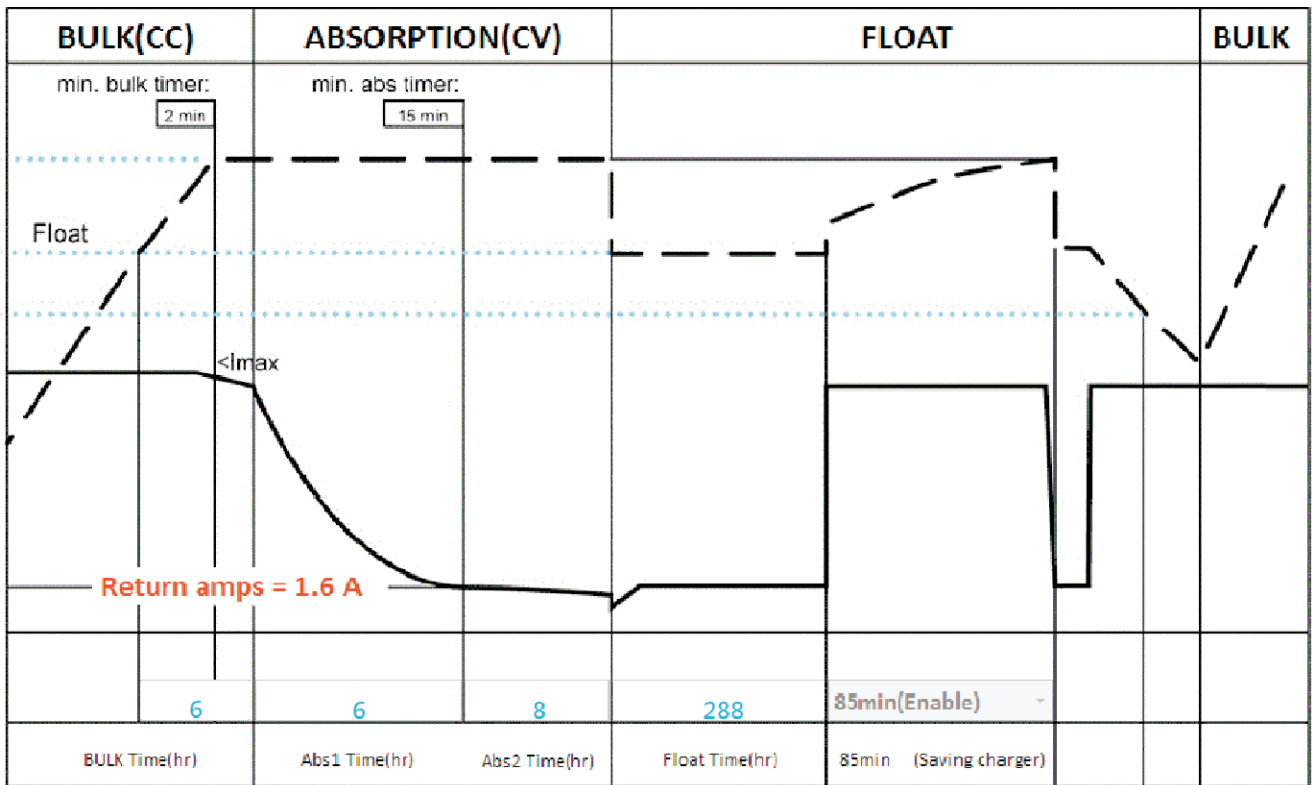

Charger Current vs Heat Sink Temperature De-rating Curve:

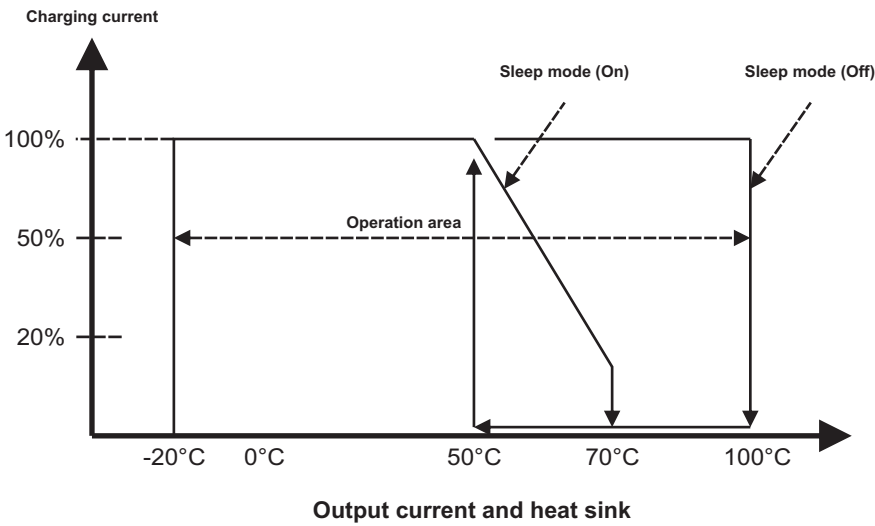

Rescue Battery Curve:

