

5mm (3/16")

M5 #10-24

4.5/4.8mm ϕ 3-6mm
No 10 1/8"-1/4"

Notes: -
For marine applications, use a silicone sealant or a bedding compound to avoid electrolytic action between the cleat and metal fastenings.

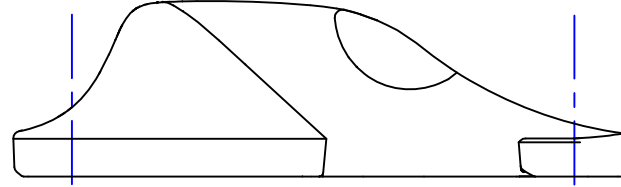
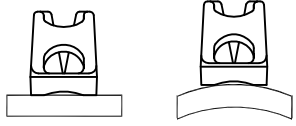

2 Holes 5.3 dia
CSK 10mmdiax90deg

Section 'A'A'

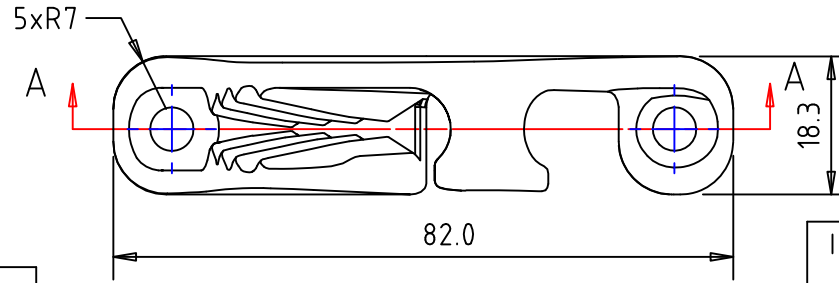
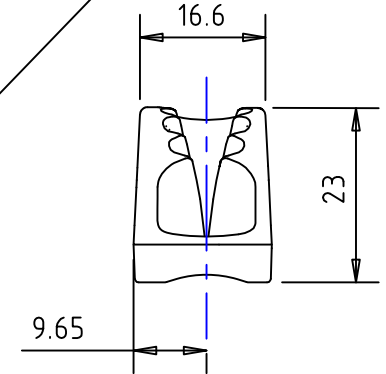
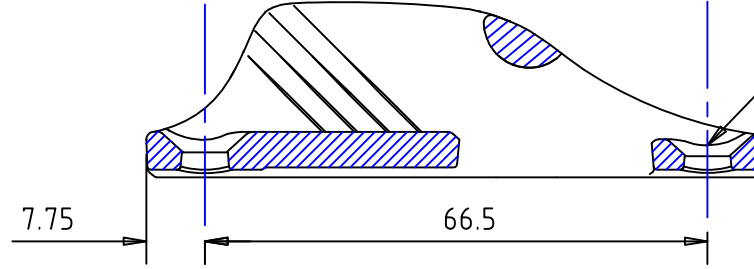
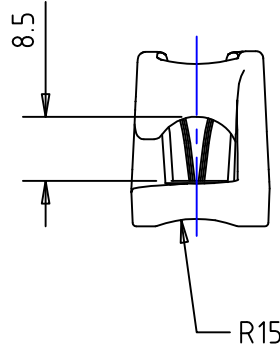

Issue: 3 Feb 2010
ID2171.dwg

Material:
Diecast Aluminium

Installation Drawing for: -
CL217 Mk 1.
Side Entry Mk 1
(Starboard)



Clamcleats Limited
Watchmead
Welwyn Garden City
Hertfordshire AL7 1AP
England
Telephone +44 (0)1707 330101
Fax +44 (0)1707 321269
Email sales@clamcleat.com
www.clamcleat.com

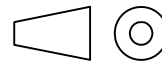

Scale 1:1
All dimensions in mm.