



# FI-3000 FiberInspector™ Pro

## Video Probe

# Getting Started Guide



PN 5003251 January 2019

©2019 Fluke Corporation

All product names are trademarks of their respective companies.

## LIMITED WARRANTY AND LIMITATION OF LIABILITY

Each Fluke Networks product is warranted to be free from defects in material and workmanship under normal use and service unless stated otherwise herein. The warranty period for the mainframe is one year and begins on the date of purchase. Parts, accessories, product repairs and services are warranted for 90 days, unless otherwise stated. Ni-Cad, Ni-MH and Li-Ion batteries, cables or other peripherals are all considered parts or accessories. The warranty extends only to the original buyer or end user customer of a Fluke Networks authorized reseller, and does not apply to any product which, in Fluke Networks' opinion, has been misused, abused, altered, neglected, contaminated, or damaged by accident or abnormal conditions of operation or handling. Fluke Networks warrants that software will operate substantially in accordance with its functional specifications for 90 days and that it has been properly recorded on non-defective media. Fluke Networks does not warrant that software will be error free or operate without interruption.

Fluke Networks authorized resellers shall extend this warranty on new and unused products to end-user customers only but have no authority to extend a greater or different warranty on behalf of Fluke Networks. Warranty support is available only if product is purchased through a Fluke Networks authorized sales outlet or Buyer has paid the applicable international price. To the extent permitted by law, Fluke Networks reserves the right to invoice Buyer for repair/replacement when a product purchased in one country is submitted for repair in another country.

For a list of authorized resellers, visit [www.flukenetworks.com/wheretobuy](http://www.flukenetworks.com/wheretobuy).

Fluke Networks warranty obligation is limited, at Fluke Networks option, to refund of the purchase price, free of charge repair, or replacement of a defective product which is returned to a Fluke Networks authorized service center within the warranty period.

To obtain warranty service, contact your nearest Fluke Networks authorized service center to obtain return authorization information, then send the product to that service center, with a description of the difficulty, postage and insurance prepaid (FOB destination). Fluke Networks assumes no risk for damage in transit. Following warranty repair, the product will be returned to Buyer, transportation prepaid (FOB destination). If Fluke Networks determines that failure was caused by neglect, misuse, contamination, alteration, accident or abnormal condition of operation or handling, or normal wear and tear of mechanical components, Fluke Networks will provide an estimate of repair costs and obtain authorization before commencing the work. Following repair, the product will be returned to the Buyer transportation prepaid and the Buyer will be billed for the repair and return transportation charges (FOB Shipping point).

THIS WARRANTY IS BUYER'S SOLE AND EXCLUSIVE REMEDY AND IS IN LIEU OF ALL OTHER WARRANTIES, EXPRESS OR IMPLIED, INCLUDING BUT NOT LIMITED TO ANY IMPLIED WARRANTY OF MERCHANTABILITY OR FITNESS FOR A PARTICULAR PURPOSE. FLUKE NETWORKS SHALL NOT BE LIABLE FOR ANY SPECIAL, INDIRECT, INCIDENTAL OR CONSEQUENTIAL DAMAGES OR LOSSES, INCLUDING LOSS OF DATA, ARISING FROM ANY CAUSE OR THEORY.

Since some countries or states do not allow limitation of the term of an implied warranty, or exclusion or limitation of incidental or consequential damages, the limitations and exclusions of this warranty may not apply to every buyer. If any provision of this Warranty is held invalid or unenforceable by a court or other decision-maker of competent jurisdiction, such holding will not affect the validity or enforceability of any other provision.









# FI-3000 FiberInspector™ Pro



## Video Probe

### Getting Started Guide

The FI-3000 FiberInspector Pro is hand-held probe used to inspect fiber optic endfaces on MPO connectors. You use the probe with your mobile device and the FI-IN application to view and analyze endfaces and share and save test results.

## Symbols

	Warning or Caution: Risk of damage or destruction to equipment or software. See explanations in the manuals.
	Warning: Risk of fire, electric shock, or personal injury.
	Consult the user documentation.
	Conformite Europeene. Conforms to the requirements of the European Union and the European Free Trade Association (EFTA).
	Certified by CSA Group to North American safety standards.
	Conforms to relevant Australian standards.
	Conforms to the Appliance Efficiency Regulation (California Code of Regulations, Title 20, Sections 1601 through 1608), for small battery charging systems.
	<p>This Product complies with the WEEE Directive marking requirements. The affixed label indicates that you must not discard this electrical/electronic product in domestic household waste. Product Category: With reference to the equipment types in the WEEE Directive Annex I, this product is classed as category 9 "Monitoring and Control Instrumentation" product. Do not dispose of this product as unsorted municipal waste. To return unwanted products, contact the manufacturer's web site shown on the product or your local sales office or distributor.</p> <p>This Product contains a lithium-ion battery. Do not mix with the solid waste stream. Spent batteries should be disposed of by a qualified recycler or hazardous materials handler per local regulations. Contact your authorized Fluke Service Center for recycling information.</p>

	40 year Environment Friendly Use Period (EFUP) under China Regulation - Administrative Measure on the Control of Pollution Caused by Electronic Information Products. This is the period of time before any of the identified hazardous substances are likely to leak out, causing possible harm to health and the environment.
	This key turns the Product on and off.

## Safety Information

### Warning

To prevent possible fire, electric shock, or personal injury:

- Read all safety information before you use the Product.
- Carefully read all instructions.
- Do not open the case. You cannot repair or replace parts in the case.
- Do not modify the Product.
- Use only replacement parts that are approved by Fluke Networks.
- Do not use the Product around explosive gas, vapor, or in damp or wet environments.
- Charge the battery indoors.
- Use the Product only as specified, or the protection supplied by the Product can be compromised.
- Do not use and disable the Product if it is damaged.
- Do not use the Product if it operates incorrectly.
- Batteries contain hazardous chemicals that can cause burns or explode. If exposure to chemicals occurs, clean with water and get medical aid.
- Replace the rechargeable battery after 5 years of moderate use or 2 years of heavy use. Moderate use is defined as recharged twice a week. Heavy use is defined as discharged to cutoff and recharged daily. To replace the battery, send the Product to an authorized Fluke Networks Service Center.
- Disconnect the battery charger and move the Product or battery to a cool, non-flammable location if the rechargeable battery becomes hot (>50 °C, >122 °F) during the charge period.

- **Repair the Product before use if the battery leaks.**
- **Recharge the batteries when the low battery indicator shows to prevent incorrect measurements.**
- **Do not disassemble or crush battery cells and battery packs.**
- **Do not put battery cells and battery packs near heat or fire. Do not put in sunlight.**
- **Have an approved technician repair the Product.**
- **Use only AC adapters approved by Fluke Networks for use with the Product to supply power to the Product and charge the battery.**
- **Do not look directly into optical connectors. Some optical equipment emits invisible radiation that can cause permanent damage to your eyes.**

# 1 Charge the Battery

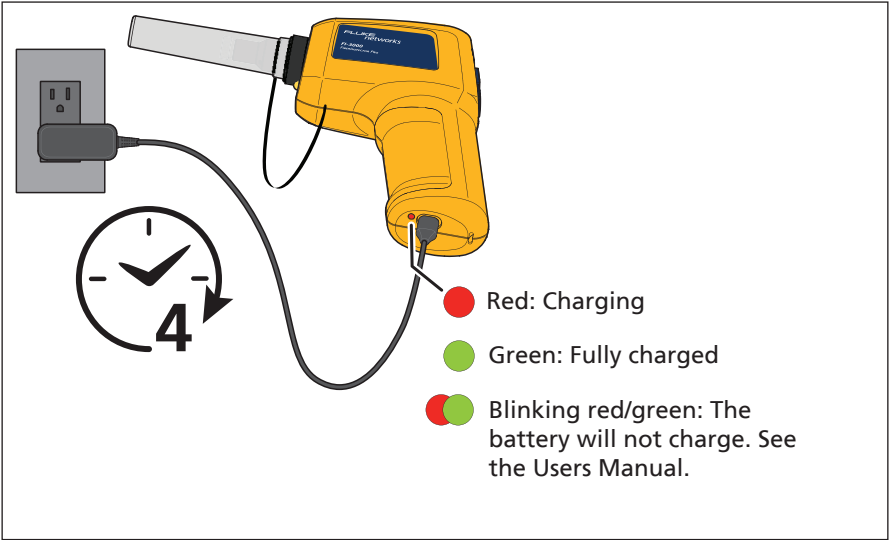

CL01.EPS

# 2 Get the FI-IN Application

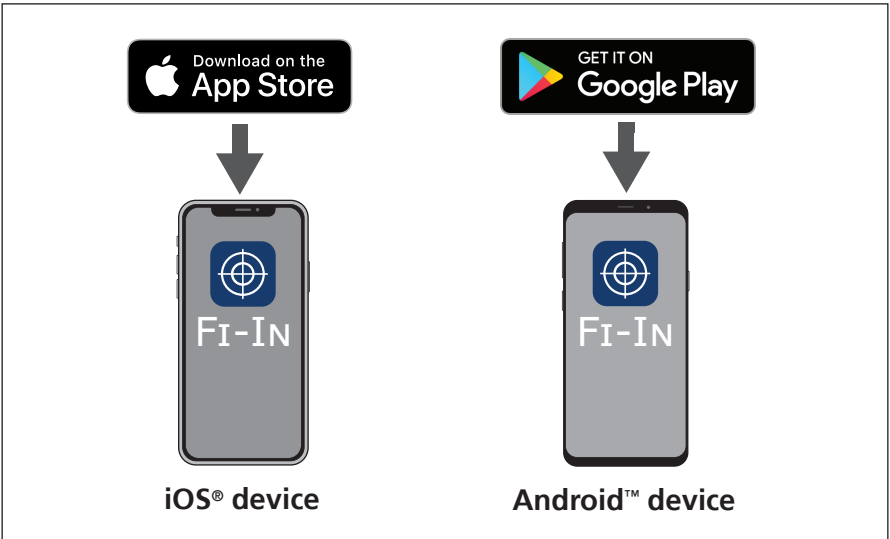

CL02.EPS

### 3 Attach the Correct Tip

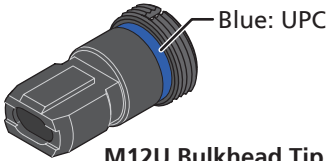

12 to 24 fibers, UPC

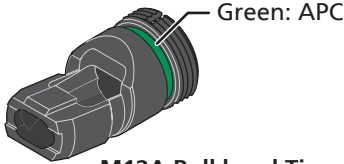

12 to 24 fibers, APC

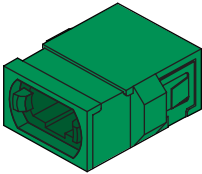

Green MPO Adapter  
Opposed Keys

For APC patch cord connectors,  
12 to 24 fibers

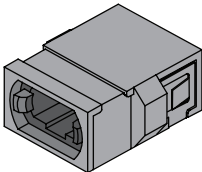

Gray MPO Adapter  
Aligned Keys

For UPC patch cord connectors,  
12 to 24 fibers

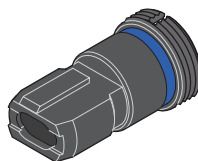
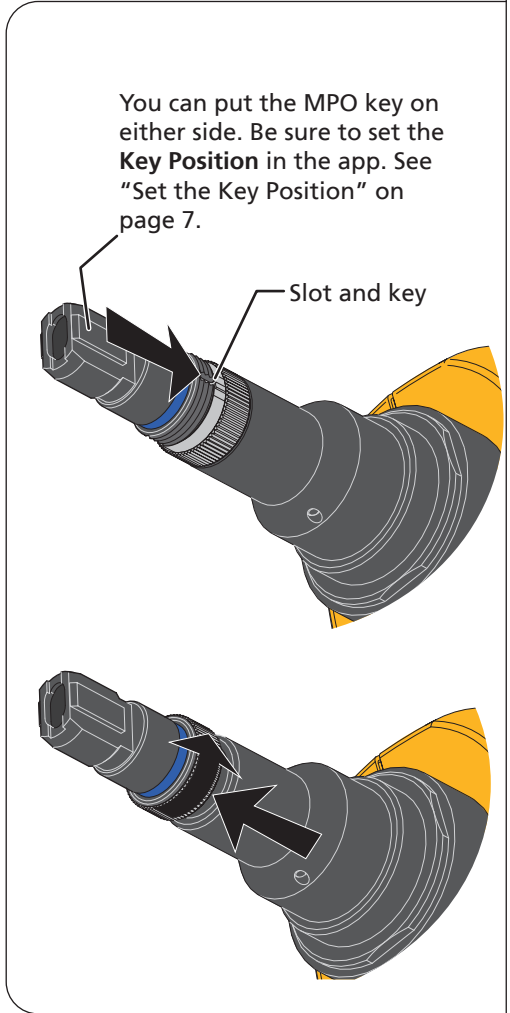

M16U Bulkhead Tip  
(optional)

16 to 32 fibers, UPC

## 4 Connect the Probe to Your Mobile Device

### Note

The password is the same (1234567890) for all probes. You cannot change the password.

If your mobile device shows a message about no internet access, choose to stay connected to the probe.

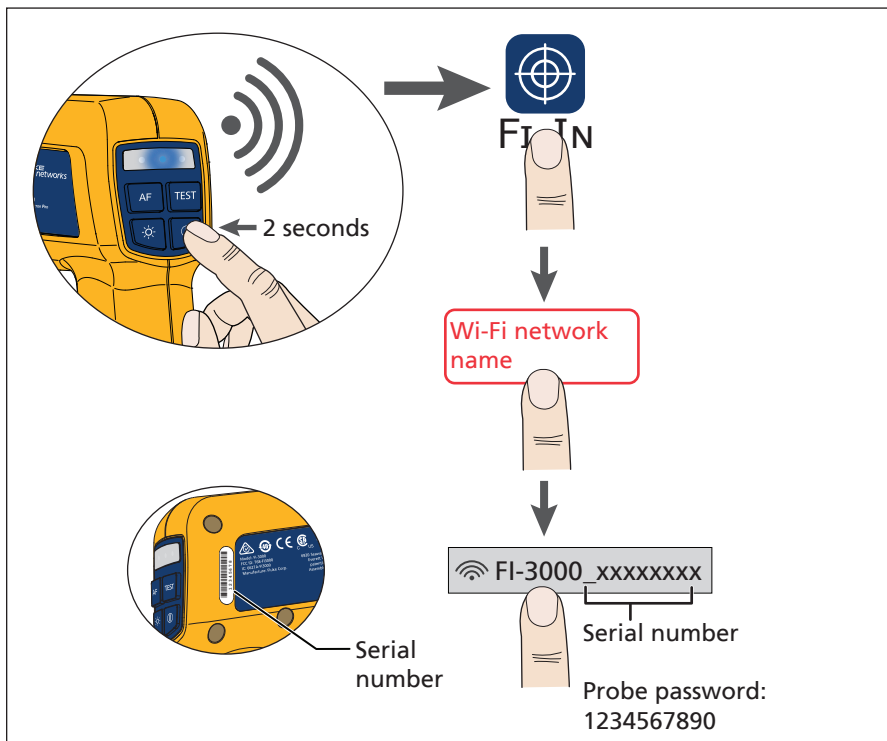

CL03.PDF

## 5 Select Test Settings

- 5-1 Open the Fi-IN app.
- 5-2 Tap  then tap the **Current Project**. Or, to create a new project tap **Manage Projects** the tap **Add**.



## 6 Set the Key Position

You can attach the MPO inspection tips to the probe with the MPO key on the left or right. This lets you rotate the probe when a cabinet door or other surface is in the way of the probe's handle.

The fiber numbers in your test results will agree with the numbers for the MPO connector when you meet these two conditions:

- You set the **Key Position** at the bottom of the **Live View** screen to the key position you use on the probe.
- The bulkhead adapter or the adapter you use to connect to a patch cord has opposed key positions (key up/key down).

## 7 Inspect Endfaces

- To capture and analyze an image of an endface, press **AF** to focus the image, then press **TEST** or tap **Test**.
- To see the **Live Image** again, tap **←** or tap **Live**.
- If you rotate the adapter tip on the probe, tap **Key Position** to change the setting.

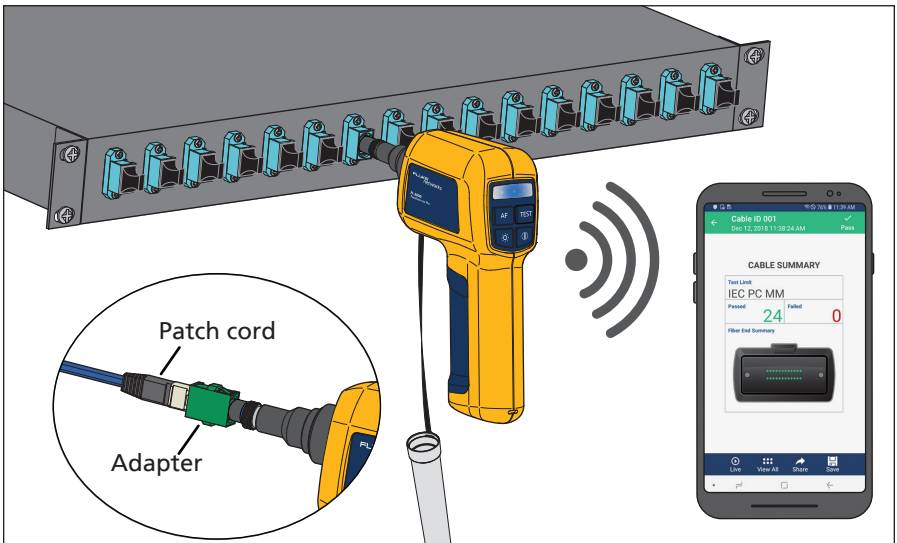

CL04.PDF

## 8 View, Share, and Save Results

- To see a high-resolution image, tap the endface graphic on the **CABLE SUMMARY** screen. Use finger gestures to move and zoom the image.
- To see highlighted defects on an endface, tap the endface in the high-resolution image.
- To see or hide the overlay that shows the green (**PASS**) and red (**FAIL**) rings and the highlighted defects, tap the image.
- To send the image or test report to an email recipient or social media account, tap **Share** on any results screen.
- To save the result in the current project, tap **Save** on any results screen.

## Learn More

- Download the Users Manual: [www.flukenetworks.com/support/manuals](http://www.flukenetworks.com/support/manuals)
- Read articles in the Knowledge Base: [www.flukenetworks.com/knowledge-base](http://www.flukenetworks.com/knowledge-base)

## Register Your Product

Registering your product with Fluke Networks gives you access to valuable information on product updates, troubleshooting tips, and other support services.

To register, go to the Fluke Networks website and sign in to your account.

## Contact Fluke Networks



[www.flukenetworks.com/support](http://www.flukenetworks.com/support)



[info@flukenetworks.com](mailto:info@flukenetworks.com)



1-800-283-5853, +1-425-446-5500



Fluke Networks  
6920 Seaway Boulevard, MS 143F  
Everett WA 98203 USA

Fluke Networks operates in more than 50 countries worldwide. For more contact information, visit our website.

# General Specifications

<b>Battery</b>	Type: Lithium-ion, 3.6 V, 6400 mAh
<b>Power Adapter</b>	Input: 100 to 240 VAC $\pm$ 10%, 50/60Hz Output: 15 VDC, 2 A maximum Class II
<b>Wireless Transmission*</b>	Output power: 72.11 mW Frequency ranges: 2400 MHz to 2483.5 MHz
<b>Wi-Fi Radio</b>	SimpleLink™ Wi-Fi® CC3220MOD Wireless Microcontroller Module (IEEE 802.11 b/g/n) Brand: Texas Instruments Model: CC3220MODSF12MOB FCC ID: Z64-CC3220MOD Band: 2400 MHz to 2483.5 MHz Output: 0.1074 W Manufacturer: Texas Instruments Incorporated Address: 12500 TI BLVD., Dallas Texas, 75243
<b>Temperature</b>	Operating: -10 °C to +45 °C (+14 °F to +113 °F) Charging: 0 °C to +40 °C (+32 °F to +104 °F) Storage: -10 °C to +60 °C (+14 °F to +140 °F)
<b>Altitude</b>	Operating: 4,000 m (3,200 m with AC adapter) Storage: 12,000 m
* For more information, go to <a href="http://www.flukenetworks.com/support/manuals">www.flukenetworks.com/support/manuals</a> , select the product name, then find "Radio Frequency Data for Class A" in the list of manuals.	

