

DYMO[®]



User Guide

DYMO[®] LabelWriter[®] Label Printers



www.dymo.com

Copyright

© 2009 Sanford, L.P. All rights reserved. Revised 12/17.

No part of this document or the software may be reproduced or transmitted in any form or by any means or translated into another language without the prior written consent of Sanford, L.P.

Trademarks

DYMO and LabelWriter are registered marks in the United States and other countries. All other trademarks are the property of their respective holders.

FCC Statement

The user is cautioned that changes or modifications not expressly approved by the party responsible for compliance could void the user's authority to operate the equipment.

Note: This equipment has been tested and found to comply with the limits for a Class B digital device, pursuant to part 15 of the FCC Rules. These limits are designed to provide reasonable protection against harmful interference in a residential installation. This equipment generates, uses and can radiate radio frequency energy and, if not installed and used in accordance with the instructions, may cause harmful interference to radio communications. However, there is no guarantee that interference will not occur in a particular installation. If this equipment does cause harmful interference to radio or television reception, which can be determined by turning the equipment off and on, the user is encouraged to try to correct the interference by one or more of the following measures:

- Reorient or relocate the receiving antenna.
 - Increase the separation between the equipment and receiver.
 - Connect the equipment into an outlet on a circuit different from that to which the receiver is connected.
 - Consult the dealer or an experienced radio/TV technician for help.
-

Contents

Safety Precautions	iv
About the LabelWriter Printer	1
LabelWriter Printer Features	1
System Requirements	3
Printing Labels	3
Developer and SDK Information	3
About Labels	5
Loading Labels	5
Ordering Labels	7
Printing Over a Network	9
Printing to a Shared Printer from Windows	9
Sharing a Printer on a Network	9
Adding a Network Printer	13
Printing to a Shared Printer from Mac OS	13
Sharing a Printer on a Network	13
Adding a Shared Printer	14
Using a Print Server	15
Printer Firmware Versions that Support Print Servers	16
Caring for Your Printer	17
Getting Help	19
Troubleshooting	19
Status Light	19
Performing a Printer Self-Test	20
Clearing Label Jams	20
Correcting Poor Print Quality	20
Labels Do Not Feed Correctly	20
Printer Does Not Print or Stops Printing	21
Limited Warranty	22
Obtaining Technical Support	22
Technical and Environmental Information	23
Technical Specifications	23
LabelWriter SE450 Printer Technical Specifications	24
Device Certification	24
Environmental Information	25
Documentation Feedback	25

Safety Precautions

Read and understand all of the precautions listed below. Follow all warnings and instructions marked on the product.

General

- Dispose of plastic bags correctly and keep away from babies and children.
- Place the product on a flat, stable surface.
- Always use the product as instructed in this user guide.
- Unplug the power cord immediately if you notice any abnormal odor, heat, smoke, discoloration, deformation or anything unusual while using the product.
- Do not disassemble the product. For inspection, adjustment and repair of the product, contact DYMO Customer Support.
- Do not drop, hit, or otherwise mishandle the product.
- Do not allow any liquids to come into contact with the product.
- Make sure to turn off the power, if applicable, and remove the power cord from the electrical outlet before cleaning the product. Failure to do so could cause an electrical shock or fire.
- Do not insert foreign objects into the product.
- Do not use paint thinner, benzene, alcohol or any other organic solvents to clean the product. Doing so may cause damage to the surface finish. Use a soft, dry cloth to clean the product.

Power

- Use only the power cord and adapter that came with the product.
- Do not handle the power cord or adapter if your hands are wet.
- Do not cut, damage, alter, or place heavy objects on the power cord.
- Do not use the power cord or adapter if they are damaged.
- Do not pull the power cord when removing the plug from the electrical outlet. Doing so could cause an electrical shock or fire.
- Do not use the power adapter in a confined space or cover it with a cloth. Make sure there is sufficient ventilation to prevent the power adapter from overheating.
- If the product will not be used for an extended period of time, remove the power cord from the electrical outlet.

Printer

- Do not put fingers in moving parts or openings of the product.
- Do not block or insert objects into the label exit slot.
- Do not touch the tear bar. Personal injury could result.
- Do not place the product in areas exposed to direct sunlight, near heaters or other hot appliances, or in any area exposed to extremely high or low temperatures, high humidity, or excessive dust.
- Do not hold or lift the product by the cover.

Labels

- Use only DYMO-branded labels. The product's warranty does not cover any malfunction or damage caused by the use of third-party labels.
- Apply labels only to a clean, dry surface at room temperature.
- Do not expose label rolls to direct sunlight, high temperatures, high humidity, or dust. Store in a cool, dark place.

Chapter 1

About the LabelWriter Printer

Congratulations on purchasing a DYMO LabelWriter label printer. Your LabelWriter printer will give you years of reliable label printing. We encourage you to take a few minutes to review how to use and care for your printer.

This manual provides information about the following printer models:

- LabelWriter 450
- LabelWriter 450 Turbo
- LabelWriter 450 Twin Turbo
- LabelWriter 450 Duo
- LabelWriter 4XL
- LabelWriter SE450

For complete information about programming and using the LabelWriter SE450 printer, refer to the *LabelWriter SE450 Technical Reference Guide*, available from the Developers Program page on the DYMO Web site (www.dymo.com).

LabelWriter Printer Features

Your LabelWriter printer is a direct thermal printer and does not use ink or toner. Instead, the printer uses heat from a thermal print head to print on specially treated, heat-sensitive labels. Labels are the only supplies you will ever need to buy.

Become familiar with the major components of the printer.

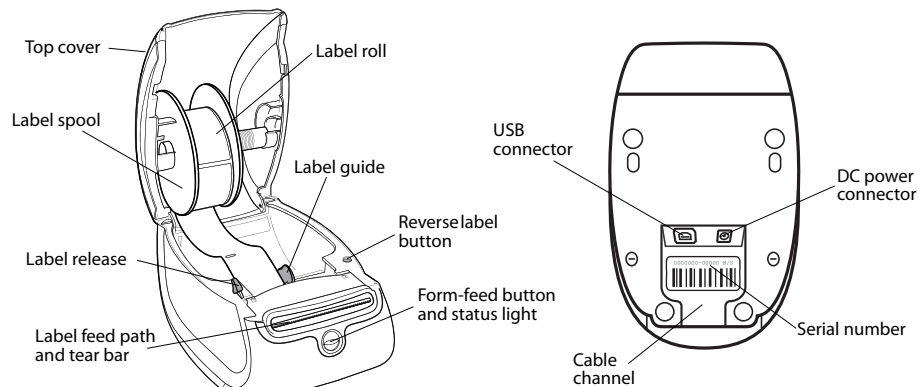

LabelWriter 450
LabelWriter 450 Turbo

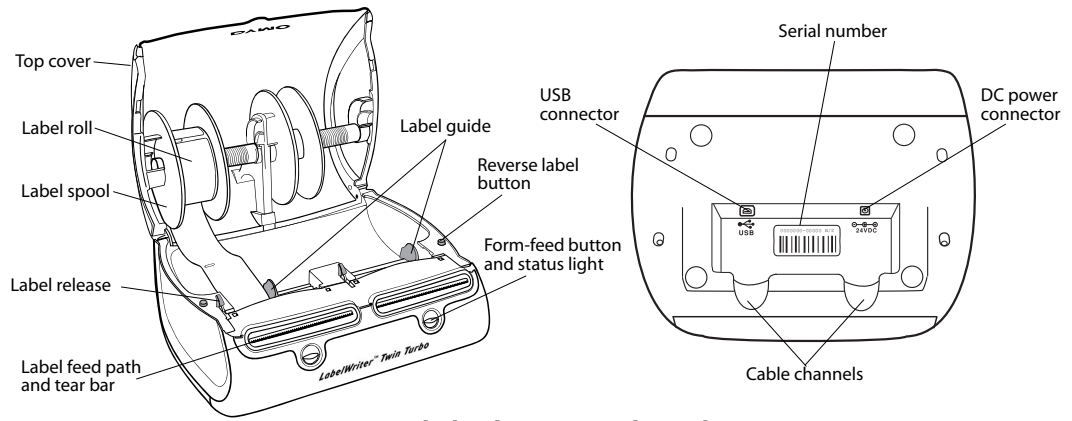

LabelWriter 450 Twin Turbo

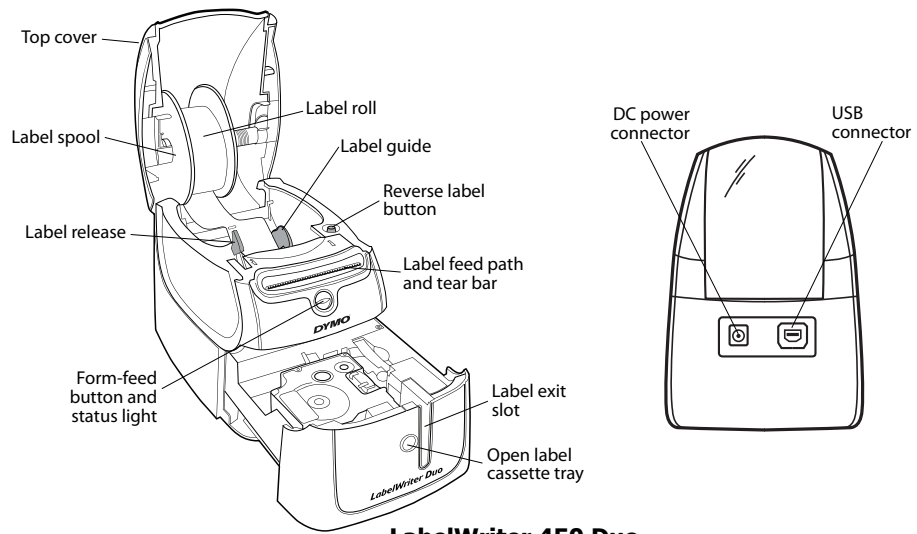

LabelWriter 450 Duo

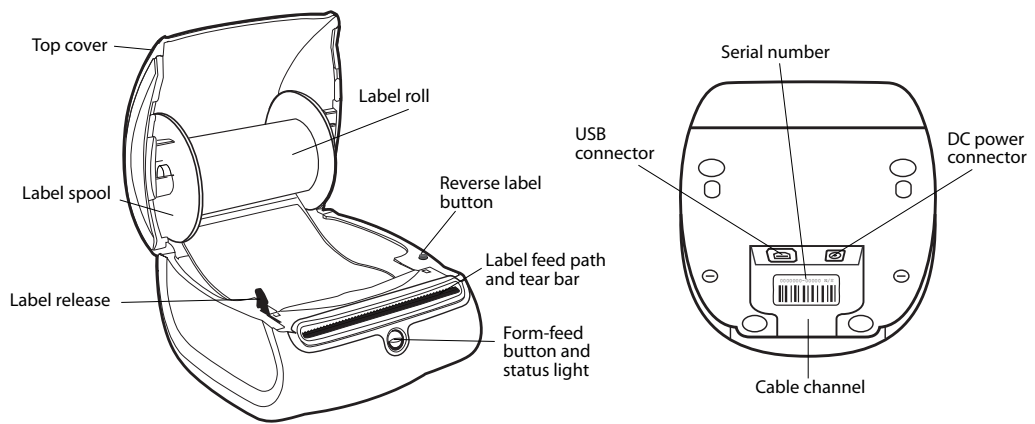

LabelWriter 4XL

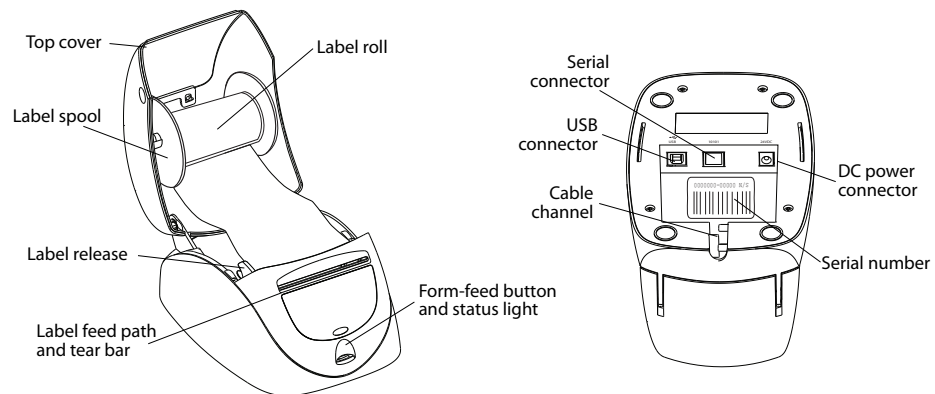
**LabelWriter SE450**

The form-feed button on the front of the printer advances a single label. The reverse label button is used to remove labels from the printer when changing rolls. The LabelWriter SE450 printer does not include a reverse label button.

The status light visually shows the current state of the printer. Refer to "Status Light" on page 19 for a complete description of the status light.

System Requirements

The LabelWriter printer requires a USB 1.1 or USB 2.0 connection and one of the following:

- Windows® XP 32-bit
- Windows Vista®
- Windows® 7
- Mac OS® v10.4 or later

To use the LabelWriter SE450 printer with a serial connection, an RS-232 serial port is required.

Printing Labels

Your LabelWriter printer was shipped with DYMO Label v.8 software to make designing and printing labels easy. You can also print labels directly from the desktop with QuickPrint, and from Microsoft Word, Excel, and Outlook with DYMO Label Add-ins that are installed when you install DYMO Label v.8 software. See the DYMO Label v.8 online Help or Software User Guide for more information on using these features.

Developer and SDK Information

DYMO provides various types of information designed to help developers create products that work with the LabelWriter printers and DYMO Label software. Below are some notes for those interested in developing products that work with LabelWriter printers.

- Keep in mind that LabelWriter printers use standard printer drivers. Therefore, printing to a LabelWriter printer is no different than printing to a laser or inkjet printer, except that the pages are smaller.

- In cases where you want to automate printing and take advantage of the label printing power built into DYMO Label software, a Software Developer's Kit (SDK) is included in your LabelWriter CD. The SDK provides COM and .NET interfaces. For more information, visit the Developer Program page on the DYMO web site. www.dymo.com.

You can check the Developer's forum on the DYMO Web site at www.dymo.com for the latest news. Also, you can join the Developer's mailing list to obtain developer-specific news and announcements.

For complete information about connecting the LabelWriter SE450 printer to the host computer or other device, and for information about programming and using the LabelWriter SE450 printer, refer to the *LabelWriter SE450 Technical Reference Guide*, available from the Developers Program page on the DYMO Web site (www.dymo.com).

Chapter 2

About Labels

DYMO LabelWriter printers use advanced *thermal* printing technology to print on specially treated, heat-sensitive labels. This means you will never have to replace toner, ink cartridges, or a ribbon to print labels.

Note DYMO's warranty does not cover malfunction or damage that may be caused by the use of labels other than DYMO-branded labels. Because DYMO LabelWriter printers use thermal printing technology, you must use specially designed and manufactured labels. The thermal coatings used on labels other than DYMO-branded labels may not be compatible, and may provide unsatisfactory printing or cause the printer to malfunction.

How long your labels will last depends on how the labels are used. Thermal paper labels, such as those printed by the LabelWriter printer, are susceptible to fading in two ways:

- Exposure to direct sunlight, to fluorescent light for an extended period of time, or to extreme heat will cause fading.
- Contact with plasticizers (for example, labels placed on plastic ring binders) will cause fading.

In the original packaging, the shelf life for LabelWriter labels is 18 months. When labels are used for short-term applications (envelopes, packages, and so on), fading is not a problem. When labels are used to label files in a file cabinet, fading is very gradual over many years. Labels applied to the edge of a notebook that is then placed on a shelf in the sun will show signs of fading within a few months.

To prolong label life when labels are not in use, store the labels in a cool, dry place and in the black bag in which they were originally packaged.

Loading Labels

Each label roll comes in a black plastic bag. Make sure to store the label roll in this bag when the labels are not being used.

The LabelWriter Twin Turbo printer holds two label rolls, so you can print two types of labels without having to change the label roll.

The LabelWriter Duo printer prints two types of labels: die-cut paper labels (such as Address or Shipping labels) and D1 plastic labels.

Important!

In order for the labels to feed properly during printing, pay attention to the following when loading labels on the spool and into the printer:

- The label spool guide must be pushed flush against the label roll, with no gap. See Figure 2.
- The labels must be loaded with the left edge of the label inserted against the left edge of the label feed slot. See Figure 4.

Figures 3 and 4 in this section show loading labels in a LabelWriter 450 printer. However, the instructions apply to loading labels in any LabelWriter printer model.

To load a label roll

- 1 With the printer plugged in, press the form-feed button to eject the labels that protected the printer during shipment.
- 2 Open the top cover and remove any packing material inside the label compartment.
- 3 Remove the label spool from inside the cover and separate the spool guide from the spindle.
- 4 Hold the spool spindle in your left hand and place the label roll on the spindle so that the labels feed from underneath and the left edge of the label roll is firmly against the side of the spool. See Figure 1.

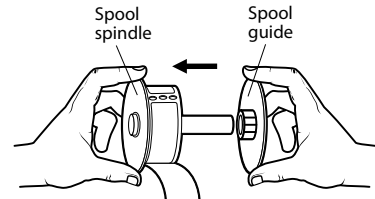

Figure 1

- 5 Slide the spool guide onto the right side of the spool and press the guide tightly against the side of the label roll, **leaving no gap** between the roll and the spool. See Figure 2.

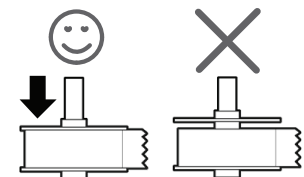

Figure 2

Note To ensure proper feeding of labels during printing, the label roll must fit snugly against both sides of the label spool, with no gaps.

- 6 Insert the label spool into the slot in the printer cover with the labels extending from underneath the roll. See Figure 3.
- 7 Align the left edge of the label with the left edge of the label feed slot and insert the label into the slot. See Figure 4.

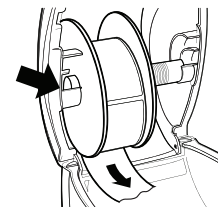

Figure 3

The printer automatically feeds the labels, stopping at the beginning of the first label.

If the printer does not feed the labels, make sure the first label is fully inserted and then press the form-feed button.

If the first label on the roll is not a full label, press the form-feed button to eject the partial label.

Note Regardless of the label width, the left edge of the label must be aligned with the left edge of the label feed slot for the labels to feed properly.

- 8 **(450, 450 Turbo, Duo, and Twin Turbo Only)** Slide the label guide to the left until the label guide aligns with the right edge of the label. See Figure 4.

Make sure that the label guide does not pinch the label.

- 9 **(Twin Turbo Only)** Repeat steps 3-8 to load a second roll of labels.

- 10 Carefully lower the top cover.

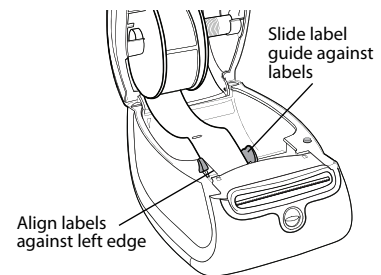

Figure 4

To load a label cassette (LabelWriter Duo)

- 1 Press the button on the front of the printer to open the label cassette tray.

Note The first time you use the printer, remove the protective cardboard insert from the label exit slot. See Figure 5.

- 2 Make sure the label and ribbon are taut across the mouth of the cassette and that the label passes between the label guides.

If necessary, turn the ribbon rewind spool clockwise to tighten the ribbon.

- 3 Insert the cassette and press firmly until the cassette clicks into place. Make sure label and ribbon are positioned correctly. See Figure 6.
- 4 Press the button on the front of the printer to close the label cassette tray.

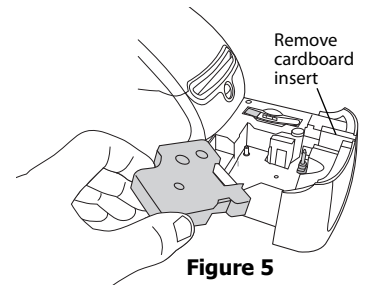
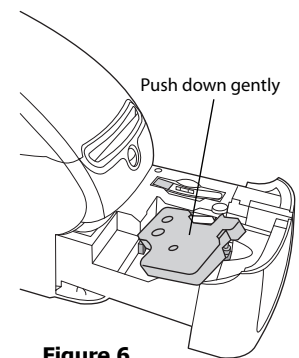
**Figure 5****Figure 6**

Ordering Labels

DYMO offers a full range of labels for the LabelWriter printers, including labels suited for addressing envelopes, shipping packages, naming file folders, labeling all sorts of media, printing name badges, and much more. A complete listing can be found at the DYMO Web site:

www.dymo.com.

Caution DYMO's warranty does not cover malfunction or damage that may be caused by the use of labels other than DYMO-branded labels. Because DYMO LabelWriter printers use thermal printing technology, you must use specially designed and manufactured labels. The thermal coatings used on labels other than DYMO-branded labels may not be compatible and may provide unsatisfactory printing or cause the printer to malfunction.

This page intentionally left blank for double-sided printing.

Chapter 3

Printing Over a Network

This chapter describes how to print to a DYMO label printer over a network. The topics covered in this chapter are:

- “Printing to a Shared Printer from Windows”
- “Printing to a Shared Printer from Mac OS”
- “Using a Print Server”

The following are the general steps you need to follow to set up a printer for printing over a network. These steps are provided as a general overview and reminder that you must be able to print locally to the printer before you can share it.

The term *local* computer refers to the computer to which the printer is physically connected. The term *remote* computer refers to the computer from which you wish to print to a printer on the network.

Note When printing to a shared printer, any messages generated by the printer, including error messages, are displayed on the local computer, not on the remote computer.

To print to a shared printer over a network, the remote computer must be able to access the local computer over the network. Contact your System Administrator for more information.

1. Install the printer to be shared on the local computer.
2. Confirm that you can print to the printer locally.
3. Share the printer on the local computer.
4. Install the printer on the remote computer that will be printing to the shared printer.

See "Using a Print Server" on page 15 for information on printing through a print server.

Printing to a Shared Printer from Windows

This section describes how to print to a shared DYMO label printer in a Windows workgroup. For information on printing to a shared printer under Windows Server or other versions of Windows, see your Windows documentation or contact your System Administrator.

Sharing a Printer on a Network

These instructions assume that you have already installed DYMO Label software on the local computer. See the printer's *Quick Start Guide* for information.

Before printing to a shared printer from Windows, you first need to share the printer on the local computer.

To share the printer (Windows XP)

- 1 Choose **Printers and Faxes** from the **Start** menu.

The Printers and Faxes control panel is displayed.

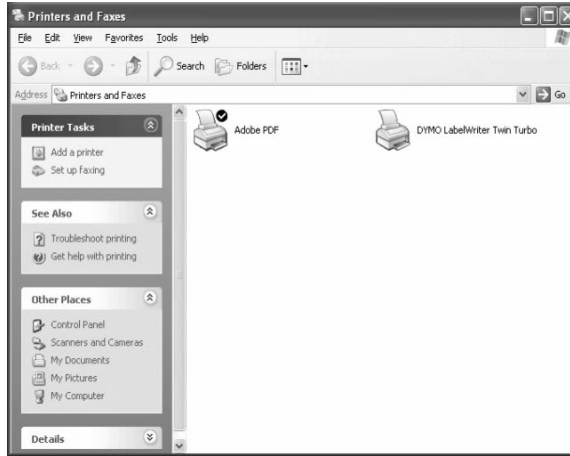

- 2 Right-click the printer you want to share and select **Sharing**.

The DYMO label printer Properties dialog box appears with the Sharing tab selected.



- 3 Select **Share this printer**.
- 4 Optionally, enter a different name for the printer in the **Share name** box. This is the printer name that appears to other users on the network.
- 5 Click **OK**.

The share icon (hand) is displayed under the shared printer. This indicates that other users in the workgroup can print to this printer.

To share the printer (Windows Vista)

- 1 Choose **Control Panel** from the **Start** menu.
- 2 In Control Panel, double-click **Printers**.

The Printers control panel is displayed.

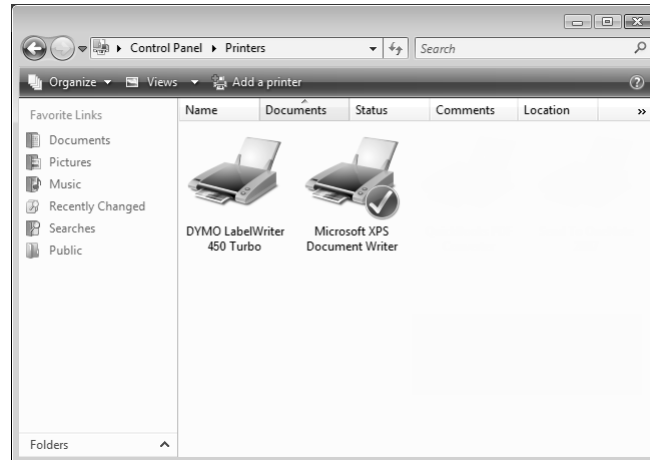

- 3 Right-click the printer you want to share and select **Sharing**.

The DYMO label printer Properties dialog box appears with the Sharing tab selected.

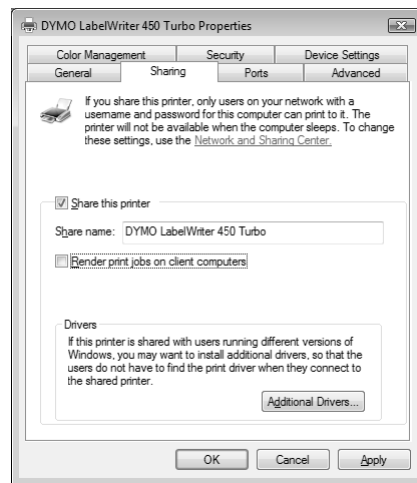

- 4 Select the **Share this printer** check box.
- 5 Optionally, enter a different name for the printer in the **Share name** box.
This is the printer name that appears to other users on the network.
- 6 Click **OK**.

The share icon (hand) is displayed under the shared printer. This indicates that other users in the workgroup can print to this printer.

To share the printer (Windows 7)

- 1 Choose **Devices and Printers** from the **Start** menu.

The Devices and Printers control panel is displayed.

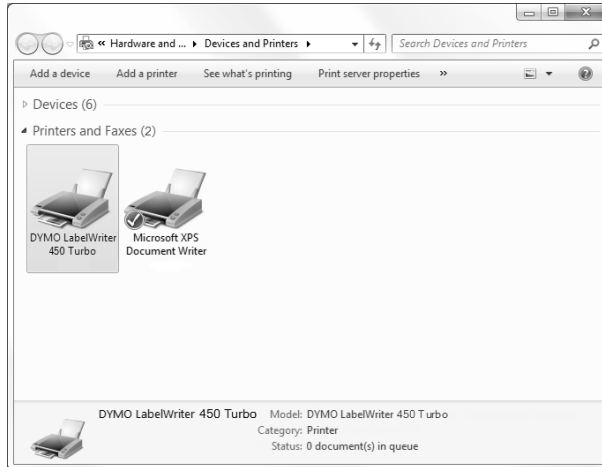

- 2 Right-click the printer you want to share and select **Printer properties**.

The DYMO label printer Properties dialog is displayed.

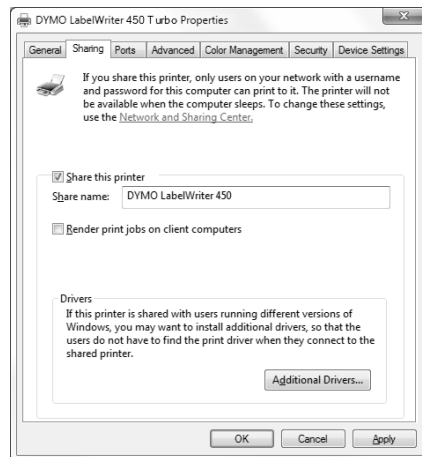

- 3 Select the **Sharing** tab.
- 4 Select the **Share this printer** check box.
- 5 Optionally, enter a different name for the printer in the **Share name** box.
This is the printer name that appears to other users on the network.
- 6 Click **OK**.

The share icon is displayed under the shared printer. This indicates that other users in the workgroup can print to this printer.

Adding a Network Printer

Before you can print to a shared network printer, you need to install DYMO Label Software (DLS) on your local computer and then add each network label printer you wish to use.

Note The LabelWriter Duo printer is actually two printers (label and tape) so you must run the Add Printer Wizard twice; once for the LabelWriter Duo label printer and once for the LabelWriter Duo tape printer.

To add a network printer

- ◆ Use the standard Windows Add Printer Wizard to add the shared label printer to your computer.

Refer to your Windows documentation for more information about adding a network printer.

Printing to a Shared Printer from Mac OS

This section describes how to print to a shared printer in a Mac OS workgroup. For information on printing to a shared printer under other versions of Mac OS, see your Mac OS documentation or contact your System Administrator.

Sharing a Printer on a Network

These instructions assume that you have already installed DYMO Label Software on the local computer. See the printer's *Quick Start Guide* for information.

Before printing to a shared printer, you first need to share the printer on the local computer.

To share the printer

- 1 Select **System Preferences** from the **Apple** menu.
The System Preferences dialog box is displayed.
- 2 Double-click **Print & Fax**.
The Print & Fax dialog box is displayed.

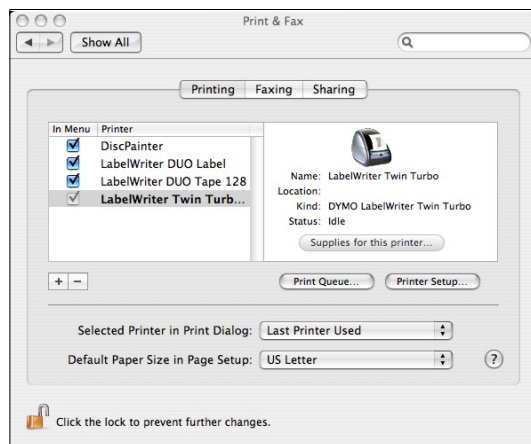

- 3 Select the printer you want to share and then click **Sharing**.
The Sharing pane is displayed.

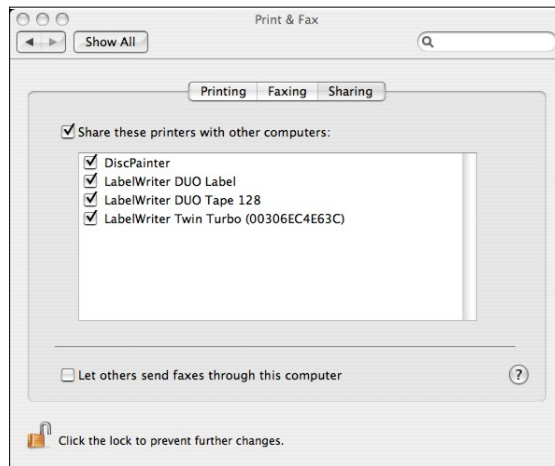

Note To share the DYMO LabelWriter Duo printer, which can print on both labels and tape, select both the LabelWriter DUO Label and the LabelWriter DUO Tape 128 printers.

- 4 Select the **Share these printers with other computers** check box and then select the check box in front of each printer you wish to share.
- 5 Close the **Print & Fax** dialog box.

Adding a Shared Printer

Before you can print to a network printer, you need to install DYMO Label software on the remote computer. If you want to install more than one shared DYMO label printer, you must add each additional label printer.

To install a shared network printer

- 1 Install DYMO Label software. (See the *Quick Start Guide* that came with your printer for information.)
- 2 From the Finder, select **Applications>Utilities>Printer Setup Utility**.
The Printer List dialog box is displayed.
- 3 Click **Add**. The Printer Browser dialog box is displayed.

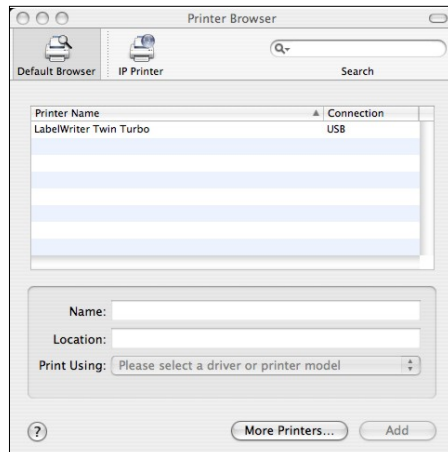

- 4 Select the printer and then click **Add**.
The shared printer is added to the Printer List dialog box.

Note The LabelWriter Duo printer is actually two printers (Label and Tape), so you must add both printers separately.

- 5 Close the Printer List dialog box.

Using a Print Server

You can print over a network to a DYMO label printer connected to a wired or wireless USB print server. DYMO now offers a LabelWriter Print Server to easily share your LabelWriter printer on a network. Visit the DYMO Web site to learn more about our print server.

A DYMO label printer works the same as any other printer connected to a print server and requires no special configuration. The steps for installing and printing with print servers vary by print server type and manufacturer. See the documentation provided with the print server for detailed installation and printing instructions.

DYMO label printers support printing from Windows XP (Service Pack 2), Windows Vista, Windows 7, and Mac OS v10.4 or later.

The following are notes and tips for the print server installation:

- Make sure that your print server supports the type of operating system installed on your computer (Windows or Mac OS).
- Most print servers only support the LabelWriter DUO Label printer. However, the DYMO LabelWriter Print Server does support both the LabelWriter DUO Label and Tape printers.
- DYMO label printers with older firmware versions do not support print servers. See Printer Firmware Versions that Support Print Servers.

In general, during print server installation, if you are prompted for the printer or printer driver, select the option for installing a printer driver from a disk and insert the DYMO Label Software CD in the computer's CD-ROM drive. If the installer doesn't automatically locate the printer drivers, navigate to the printer drivers on the CD. If prompted to select your printer, select the printer physically connected to the print server.

To connect your label printer to a print server

- 1 Connect one end of a USB cable to the USB connector on your label printer and the other end to the USB connector on the print server.
- 2 Connect the print server to your network.
- 3 Connect power to the label printer and print server.
- 4 Install and configure the print server on your network.
- 5 Confirm that you can print to the label printer from the computer you are using to install and configure the print server.
- 6 Add the printer connected to the print server to other computers in the workgroup.

Printer Firmware Versions that Support Print Servers

Refer to the table below for information about the label printer firmware versions that support print servers. You can determine your printer's firmware version by checking the serial number printed on the bottom of the printer.

DYMO Label Printer Model	Serial Numbers Greater Than	Firmware Version Greater Than
DYMO LabelWriter 400	xxxxx-2046321	93089v0T, 93490v0T
DYMO LabelWriter 400 Turbo	xxxxx-2096232	93176v0T, 93491v0T
DYMO LabelWriter Twin Turbo	xxxxx-2013955	93085v0M, 93492v0M

LabelWriter 450 Series Printers: All LabelWriter 450 series printers, including the 4XL and SE450, include firmware that supports print servers.

If your printer has firmware that does not support print servers, contact DYMO technical support for assistance on updating the printer's firmware.

Chapter 4

Caring for Your Printer

The LabelWriter printer is designed to give you long and trouble-free service, while requiring very little maintenance. You will get the best possible performance from your LabelWriter printer if you follow the setup instructions that appear in the *Quick Start Guide* and the procedures described in this section.

To keep your LabelWriter printer working properly, you should clean it from time to time. Dusting the outside of the printer occasionally will help keep foreign matter from getting inside the printer. However, it is still a good idea to periodically perform some basic interior maintenance, such as cleaning the label path with the cleaning card.

You can easily clean your LabelWriter printer using the following items:

- Lint-free cloth.
- Isopropyl alcohol, diluted dishwashing detergent, or diluted glass cleaner.
Caution If you use glass cleaner, make sure it does not contain ammonia.
- Small, soft brush, such as a tooth brush or child's paint brush.
- LabelWriter cleaning card.

To purchase cleaning cards, visit www.dymo.com.

To clean the exterior of your printer and the label roll compartment

- 1 Disconnect the power cord.
- 2 Use the lint-free cloth to wipe the exterior of the printer.
- 3 Remove dirt and smudges with one of the cleaning solutions mentioned above.
- 4 Open the top cover.
- 5 Use a small, soft brush or cotton swab to whisk away paper dust and other stray particles from the inside of the printer.
- 6 Remove the roll of labels and clean under the roll.
- 7 Reconnect the power cord.
- 8 If you have a LabelWriter cleaning card, follow the instructions printed on cleaning card packaging.
- 9 Reload the roll of labels and carefully close the top cover.

To clean the tape print head (LabelWriter Duo only)

- 1 Press the button on the front of the label cassette tray.
- 2 Remove the label cassette.
- 3 Use a small, soft brush or cotton swab to wipe away paper dust and other stray particles from the inside of the tray.
- 4 Remove the cleaning tool from the inside of the tray.
If you do not have a cleaning tool, contact [DYMO Consumer Care](#).
- 5 Gently wipe the print head with the tool.
The print head is very delicate, so use care when cleaning.
- 6 Replace the cleaning tool, insert the label cassette, and press the button to close the tray.

To clean the cutter blade (LabelWriter Duo only)

- 1 Press the button on the front of the label cassette tray.
- 2 Remove the label cassette.
- 3 Quickly press the Form Feed and Label Eject buttons at the same time.
The cutter blade will move into view.
- 4 Use a cotton swab and alcohol to clean both sides of the cutter blade.
The cutter blade is extremely sharp. Use caution when cleaning.
- 5 After cleaning the blade, press the Label Eject button once to return the blade to its home position.

You can also follow this procedure if the cutter blade becomes lodged in the forward position and will not move.

Chapter 5

Getting Help

Your LabelWriter printer should offer years of trouble-free printing with very little maintenance. However, in the event that you encounter a problem, this chapter offers suggestions for resolving problems that can occur when using the printer. If you are unable to solve a problem, this chapter also describes how to contact DYMO Technical Support.

For complete information about programming and using the LabelWriter SE450 printer, refer to the *LabelWriter SE450 Technical Reference Guide*, available from the Developers Program page on the DYMO Web site (www.dymo.com).

Troubleshooting

This section provides information on how to detect and correct problems you might encounter while using your LabelWriter printer.

Status Light

The status light visually shows the current state of the printer:

Status Light	Description
Solid Blue	Power is on and printer is ready.
Dimmed Blue	Printer is in power saving mode.
Flashing Blue	Labels are not loaded properly or the label roll is empty.

For the LabelWriter SE450, the status light shows the current state of the printer as follows:

SE450 Status Light	Description
Solid Blue	USB cable is connected. Power is on and printer is ready.
Dimmed Blue	USB cable is connected and printer is in power saving mode.
Flashing Red	Labels are not loaded properly or the label roll is empty.
Solid Green	Serial cable is connected. Power is on and printer is ready. Printer will also show solid green when both USB and Serial cables are connected or when no cables are connected.
Dimmed Green	Serial cable is connected and printer is in power saving mode.
Flashing Green	Serial cable is connected and printer is in configuration mode. For complete information about programming and using the LabelWriter SE450 printer, refer to the <i>LabelWriter SE450 Technical Reference Guide</i> , available from the Developers Program page on the DYMO Web site. www.dymo.com

Performing a Printer Self-Test

If you experience problems with broken characters or other print quality issues, perform a printer self-test. The self-test verifies that all elements of the print head and printing mechanism are in working condition.

To perform a self-test

- 1 With a roll of labels in the printer, press and hold the form-feed button on the front of the printer for five to ten seconds.

The printer begins printing vertical lines along the width of the printer. The test pattern automatically changes every 3/4 inch (19 mm).

- 2 Once the self-test begins, release the form-feed button.
- 3 To stop the self-test, press and release the form-feed button.

Clearing Label Jams

To clear labels that have become jammed in the printer

- 1 Tear off any labels that have already fed through the printer.
- 2 Press the label release lever forward and pull the jammed label out of the label feed slot.

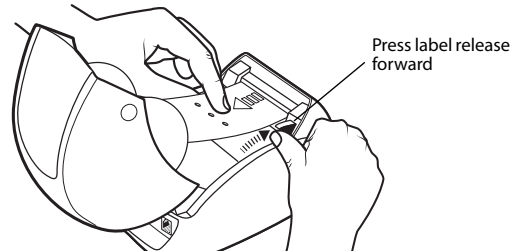

Correcting Poor Print Quality

Poor print quality is most frequently caused by one of the following:

- An old roll of labels
- Labels made by a manufacturer other than DYMO
- Labels where the thermal coating has been compromised
- A dirty print head

First, make sure you are using DYMO-branded labels. Do not use third-party labels because the thermal coating on other labels has a different sensitivity than DYMO-branded labels. Also, the perforated holes between the labels made by other manufacturers are frequently not detectable by LabelWriter printers.

If the print quality becomes faint, small dots of white appear scattered through the printed characters, or light and dark patches of printing appear, you are probably using a faulty roll of labels. Try using a different roll from a fresh box. If the second roll prints correctly, the problem is with the first roll of labels.

Another possibility is that the LabelWriter print head needs cleaning. See "Caring for Your Printer" on page 17 for information about cleaning the label path with a LabelWriter cleaning card.

Labels Do Not Feed Correctly

If your labels do not feed correctly, check the following:

- Make sure your labels are loaded properly and that the left edge of the label is aligned with the left edge of the label feed slot. See "Loading Labels" on page 5.

- Make sure you are using DYMO-branded labels. The perforated holes between the labels made by other manufacturers are frequently not detectable by DYMO printers. When the perforations are not detected, the labels will not feed correctly. Using third-party labels may also void your warranty.

Printer Does Not Print or Stops Printing

If your printer does not print or stops printing while in use, follow the steps below to track down the problem.

- 1** Make sure the printer is still getting power and that the power cable has not been disconnected. If the status light on the front of the printer is not lit, check to make sure the power cable is plugged in, and that your power strip is working. To make sure the problem is not with the outlet or power strip, try plugging something else into the wall outlet and power strip.
- 2** Confirm that the printer is feeding labels properly by pushing the form feed button while the printer is on. If the labels are jammed, the status light will blink. Refer to "Clearing Label Jams" on page 20.
- 3** Make sure that your USB cable has not come loose from the back of your printer or from your computer. Refer to the installation instructions in the *Quick Start Guide* to make sure the cable is connected properly.
- 4** (Windows) Check that your LabelWriter printer driver is installed correctly. The LabelWriter printer driver takes print data from your software and directs it to the LabelWriter printer. The driver is automatically installed when you install the software that comes with your printer. However, the driver may have been changed or deleted by mistake.
 - a** From the **Start** menu, choose **Printers and Faxes**.
 - b** Right-click the LabelWriter printer icon, and then choose **Properties**.
 - c** From the **Properties** dialog box, click **Printing Preferences**.
 - d** From the **Preferences** dialog box, click **Advanced**.

The Advanced dialog box appears.

If no errors are displayed the Advanced dialog box, the printer driver is installed correctly.

If you are still having problems after checking the above items, contact Customer Service to arrange for a Return Authorization (RA). See "Obtaining Technical Support" on page 22.

Limited Warranty

Your DYMO® LabelWriter® printer comes with a warranty against defects in materials, design, or workmanship, for two years from the original date of purchase (LabelWriter SE450 for one year from the original date of purchase), when used in accordance with all operating instructions. Normal wear and tear is not covered, nor is excessive use, abuse or damage caused by a user either intentionally or accidentally.

DYMO LabelWriter printers are designed for use only with DYMO-branded labels. This warranty does not cover any malfunction or damage caused by the use of third party labels.

EXCEPT AS PROVIDED HEREIN, DYMO MAKES NO OTHER WARRANTIES, EXPRESS OR IMPLIED, AND DYMO SPECIFICALLY EXCLUDES WARRANTIES OF MERCHANTABILITY AND FITNESS FOR A PARTICULAR PURPOSE. DYMO'S LIABILITY UNDER THIS WARRANTY SHALL BE LIMITED TO REPAIR OR REPLACEMENT OF THE PRINTER. DYMO SHALL NOT BE RESPONSIBLE FOR ANY INCIDENTAL OR CONSEQUENTIAL DAMAGES, WHETHER OR NOT FORESEEABLE.

THIS WARRANTY GIVES YOU SPECIFIC LEGAL RIGHTS, AND YOU MAY ALSO HAVE OTHER RIGHTS WHICH VARY FROM STATE TO STATE AND COUNTRY TO COUNTRY.

Special Provisions for Australia

The following provisions shall apply in addition to the above warranty if the sale of the DYMO product occurred in Australia:

- Our goods come with guarantees that cannot be excluded under the Australian Consumer Law.
- You are entitled to a replacement or refund for major failure and compensation for any other reasonably foreseeable loss or damage.
- You are also entitled to have the goods repaired or replaced if the goods fail to be of acceptable quality and the failure does not amount to a major failure.
- Any repair or replacement will be at DYMO's expense and free of charge to you.

Refer to www.dymo.com to find your local service centre contact information.

Obtaining Technical Support

If you experience problems with the setup or use of your printer, carefully read this manual to make sure you have not missed something that is covered in the documentation.

If you cannot resolve your problem by consulting the documentation, you can obtain additional information and assistance from DYMO.

DYMO maintains an Internet Web site at www.dymo.com that includes the latest support information for your LabelWriter printer.

To contact us, visit the Support area of our Web site at: www.dymo.com

Chapter 6

Technical and Environmental Information

This chapter contains technical and certification information for the LabelWriter printer.

Technical Specifications

	450	450 Turbo	450 Twin Turbo	4XL	450 Duo (Label Printer)	450 Duo (Tape Printer)
Print Method	Direct Thermal					Thermal Transfer
Print Resolution	300 dots per inch (11.8 dots per mm)					180 dots per inch (7.09 dots per mm)
Print Speed (labels/min for address label in text mode)	51	71	71	53	71	N/A
Maximum Print Width	2.25 in (56 mm)			4.16 in (105.73 mm)	2.25 in (56 mm)	0.71 in (18.1 mm)
Maximum Media Width	2.44 in (62 mm)			4.53 in (115 mm)	2.44 in (62 mm)	0.95 in (24 mm)
Maximum Label Length	User-definable					
Interface	USB 2.0 Printer Class Device					
Dimensions (WHD)	4 7/8 in (124 mm) x 5 3/4 in (146 mm) x 7 1/4 in (184 mm)		8 1/2 in (217 mm) x 5 1/3 in (135 mm) x 7 3/8 in (187.5 mm)		7 in (178 mm) x 5 1/3 in (135 mm) x 7 3/8 in (187 mm)	
Weight	1.5 pounds (0.68 kg)		2.4 pounds (1.09 kg)		1.75 pounds (0.78 kg) 3 pounds (1.35 kg)	
Printer Power Requirements	24 VDC 1.75 A			24 VDC 3.75 A		24 VDC 1.75 A
Rated Duty Cycle	1000 shipping labels per hour					
Regulatory Approvals	CE, FCC, TUV CB, cTUVus, TUV GS, and C-Tick					
Warranty	Two Year Limited					

LabelWriter SE450 Printer Technical Specifications

For complete information about connecting the LabelWriter SE450 printer to the host computer or other device, and for information about programming and using the LabelWriter SE450 printer, refer to the *LabelWriter SE450 Technical Reference Guide*, available from the Developers Program page on the DYMO Web site (www.dymo.com).

	SE450
Print Method	Direct Thermal
Print Resolution	200 dots per inch (8 dots per mm)
Print Speed (labels/min for address label in text mode)	USB: 48 lpm Serial (115.2K baud): 40 lpm
Maximum Print Width	2.13 in (54 mm)
Maximum Media Width	2.44 in (62 mm)
Maximum Label Length	User-definable
Interface	USB 2.0 Printer Class Device Bi-directional, RS232 Serial (1200 to 115.2K baud)
Dimensions (WHD)	4 7/8 in (124 mm) x 5 3/4 in (146 mm) x 7 3/8 in (187 mm)
Weight	1 pound 13 ounces (0.817 kg)
Printer Power Requirements	24 VDC 1.7 A
Rated Duty Cycle	1000 shipping labels per hour
Regulatory Approvals	CE, FCC, Industry Canada, TUV CB, cTUVus, TUV GS, and C-Tick
Warranty	One Year Limited

Device Certification

This device has been tested and complies with the requirements of:

TUV CB Test Certificate

cTUVus Certificate

TUV GS Certificate

INTERNATIONAL STANDARD IEC 60950 Safety of information technology equipment

FCC Part 15 Class B

RoHS 2002/95/EC

This device is not intended for use in the direct field of view at visual display workplaces. To avoid incommoding reflections at visual display workplaces, this device must not be placed in the direct field of view.

Environmental Information

The equipment that you bought has required the extraction and use of natural resources for its production. It may contain hazardous substances for the health and the environment.

In order to avoid the dissemination of those substances in our environment and to diminish the pressure on the natural resources, we encourage you to use the appropriate take-back systems. Those systems will reuse or recycle most of the materials of your end life equipment in a sound way.

The crossed-bin symbol marked in your device invites you to use those systems.



If you need more information on the collection, reuse and recycling systems, please contact your local or regional waste administration.

You can also contact DYMO for more information on the environmental performances of our products.

Documentation Feedback

We are constantly working to produce the highest quality documentation for our products. We welcome your feedback. Send us your comments or suggestions about our online Help, printed, or PDF manuals.

Please include the following information with your feedback:

- Product name and version number
- Type of document: printed manual, PDF, or online Help
- Topic title (for online Help) or page number (for printed or PDF manuals)
- Brief description of content (for example, step-by-step instructions that are inaccurate, information that requires clarification, areas where more detail is needed, and so on)
- Suggestions for how to correct or improve the documentation

We also welcome your suggestions for additional topics you would like to see covered in the documentation.

Send email feedback to:

documentation@dymo.com

Please keep in mind that this email address is only for documentation feedback. If you have a technical question, please contact Customer Service.

