

Bush™

BUSINESS FURNITURE



M - F 7a.m. - 11p.m.
Sat. 9a.m. - 5:30p.m.
Sun. 9a.m. - 5:30p.m.
(Except Holidays)

1-800-950-4782 USA/CANADA
95-800-950-4782 MEXICO
Se habla Español

Outside USA/ CANADA/ MEXICO:
001-716-665-2510 Ext. 5900

Email us:

ConsumerService@BushIndustries.com



www.bushfurniture.com

10 Year

WARRANTY

IT'S AS EASY AS 1,2,3

Assembly tips:

1. Read the instructions and become familiar with the parts.
2. To protect floors, assemble the furniture on the carton.
3. An assistant may be helpful.
4. Use of power tools is not recommended.

Consejos de Ensamblaje:

1. Lea las instrucciones y familiarícese con las partes.
2. Para proteger el piso, ensamble el mueble en el cartón.
3. Un asistente puede serle útil.
4. El uso de herramientas electricas no se recomienda.

Assemblage:

1. Lisez les instructions et familiarisez-vous avec les pièces.
2. Afin de protéger vos sols, assemblez votre meuble sur un carton.
3. Il sera peut-être utile de vous faire aider.
4. L'utilisation d'outils électriques n'est par recommandée.

CONSUMER SERVICE YOU CAN DEPEND ON

Questions? Operators are standing by at our TOLL FREE help line to assist you with assembly, and if necessary, quickly replace damaged/missing parts. Assistance is available all day every day. Simply have your store receipt, instruction manual, and part number/description ready when you call our TOLL FREE help line. It's that easy.

Servicio al consumidor en que usted puede depender

¿ Preguntas ? Operadores estan listos en nuestra LINEA DE ASISTENCIA GRATUITA para ayudarle con ensamblaje y si sea necesario reemplazo rápido de partes dañadas o que falten. Asistencia está disponible todo el día todos los días. Simplemente tenga listo su recibo de la tienda, la hoja de instrucciones, y número de parte/descripción cuando llame nuestra LINEA DE ASISTENCIA GRATUITA. Es así de fácil.

Vous pouvez compter sur notre service clientèle

des Questions? Nos opérateurs se tiennent à votre disposition, veuillez contacter notre NUMERO GRATUIT D'ASSISTANCE CLIENTS, où l'on vous portera assistance dans votre assemblage, et si nécessaire, pour le remplacement des pièces défectueuses ou manquantes. Cette assistance est disponible 24/24 et 7/7 jours. Quand vous appelez le NUMERO GRATUIT D'ASSISTANCE CLIENTS, veuillez simplement avoir à portée de main votre ticket d'achat, le manuel d'instructions et les références du modèle. C'est aussi simple que cela.

MODEL WC12946
WC24446
WC36746
WC48546
WC60346
WC72446

Bush
BUSINESS FURNITURE



Can we help you ?

Thank you for purchasing this Bush Business Furniture product. We trust that you will be completely satisfied with your product for many years to come. Bush Business Furniture products are backed by a 10 year warranty and crafted with today's styles in mind for the way you live.

THE BUSH FURNITURE

difference

- QUALITY
- INNOVATION
- SERVICE
- VALUE

Gracias por comprar este producto de Bush Business Furniture. Confiamos que usted estará completamente satisfecho con su mueble por muchos años. Productos de Bush Business Furniture tienen 10 años de garantía y son diseñados con los estilos de hoy en mente para la manera que usted vive.

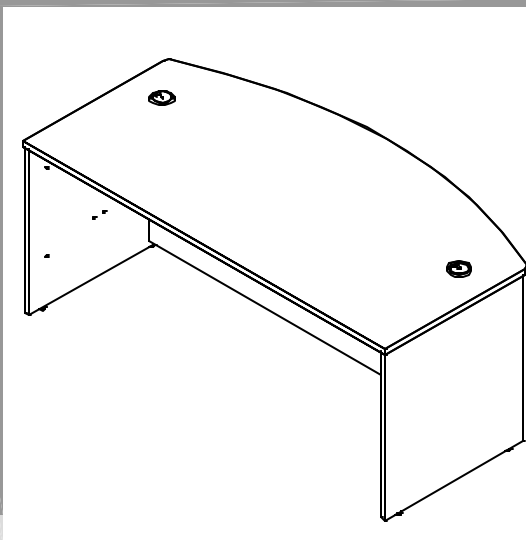

Merci d'avoir acheté ce produit Furniture Business Bush. Nous comptons sur votre entière satisfaction avec votre produit au long des années à venir. Les produits furniture Business Bush sont garantis pour une période de 10 ans et sont conçus dans les styles d'aujourd'hui gardant à l'esprit votre mode de vie.

10 Year
WARRANTY



WARNING

This product is designed and intended for use with computer, fax, and printer equipment only. Improper loading with television or other heavy equipment could cause instability, tip over, and/or serious injury.

Este producto esta diseñado solamente para el uso con computadores, faxes, e impresoras. Inapropiado uso al poner televisores u otro equipo pesado puede causar inestabilidad, rodamiento, y/o herida (golpes) serios.

Ce produit est uniquement conçu pour une utilisation avec un ordinateur, un télécopieur, ou une imprimante. Un chargement incorrect avec une télévision ou autre matériel lourd peut le rendre instable ou le renverser, et peut vous causer des endommagements sérieux.



WARNING

Do not move unit when loaded. Doing so could cause instability, product collapse, tip over, and/or serious injury.

No mueva la unidad cuando esté cargada. Hacerlo puede causar inestabilidad, que el producto se derrumbe, que se la caiga encima y/o heridas (golpes) serias.

Ne pas déplacer l'unité lorsqu'ell est chargée. Faire ainsi peut causer l'instabilité, l'effondrement ou le renversement du meuble et/ou des endommagements sérieux.

PARTS LIST

WC12946

A	[1]	W128748
B	[2]	W132823
D	[1]	W128747

WC24446

A	[1]	W129515
B	[2]	W132837
D	[1]	W129512

WC36746

A	[1]	W128750
B	[2]	W132827
D	[1]	W128741

WC48546

A	[1]	W129519
B	[2]	W132837
D	[1]	W129512

WC60346

A	[1]	W128752
B	[2]	W132831
D	[1]	W128744

WC72446

A	[1]	W129523
B	[2]	W132837
D	[1]	W129512

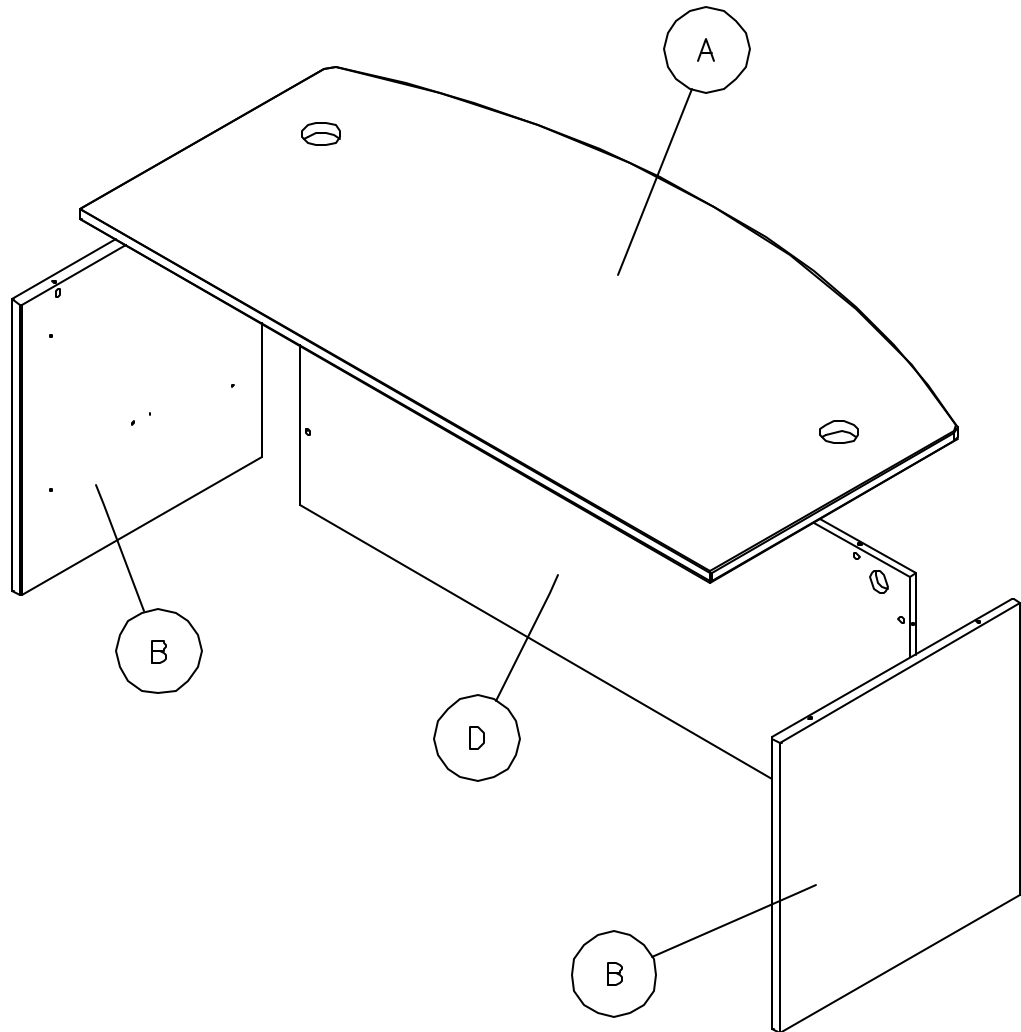
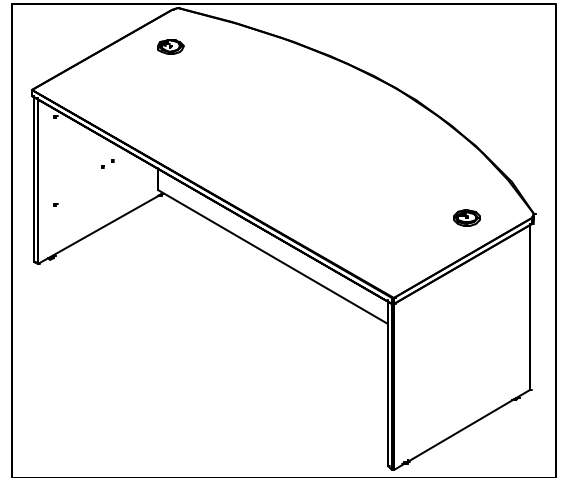

1
8
0
0
9
5
0
4
7
8
2

HARDWARE & FASTENER LIST

2
1
8
0
0
9
5
0
4
7
8
2

H26053 Quantity
8

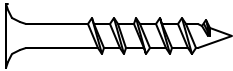

#10 x 1-1/4"

H24806 Quantity
4

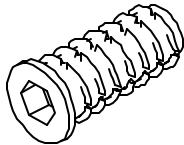

H38169 Quantity
2



8 x 30mm

H24807 Quantity
1

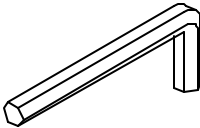

H71659 Quantity
11

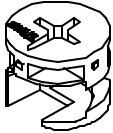

H30767 Quantity
4

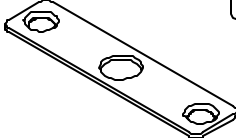

H72988 Quantity
11

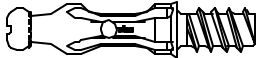



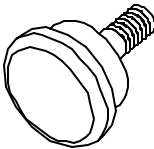

H39696 Quantity
4

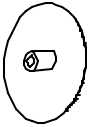
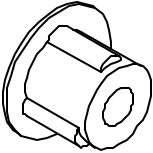
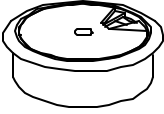
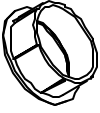
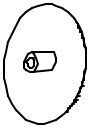
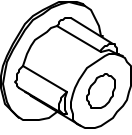

MODEL SPECIFIC HARDWARE

2
1
8
0
0
9
5
0
4
7
8
2

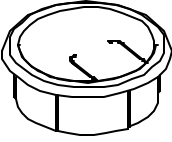
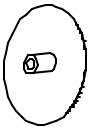
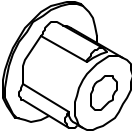
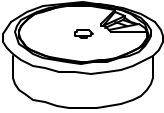
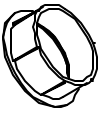
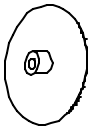
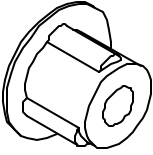

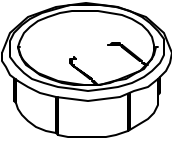
<p>H73621</p>  <p>Quantity 11</p>	<p>H63904</p>  <p>Quantity 8</p>	<p>WC12946</p>
<p>H84026</p>  <p>Quantity 2</p>	<p>H107354</p>  <p>Quantity 2</p>	
<p>H92521</p>  <p>Quantity 11</p>	<p>H92523</p>  <p>Quantity 8</p>	<p>WC24446 WC48546 WC72446</p>
<p>H84026</p>  <p>Quantity 2</p>	<p>H107716</p>  <p>Quantity 2</p>	
<p>H107306</p>  <p>Quantity 11</p>	<p>H107309</p>  <p>Quantity 8</p>	<p>WC36746</p>
<p>H84026</p>  <p>Quantity 2</p>	<p>H107354</p>  <p>Quantity 2</p>	
<p>H87676</p>  <p>Quantity 11</p>	<p>H100012</p>  <p>Quantity 8</p>	<p>WC60346</p>
<p>H127791</p>  <p>Quantity 2</p>	<p>H107716</p>  <p>Quantity 2</p>	

H72988 [4]

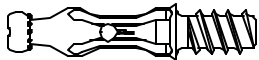

E24806 [4]

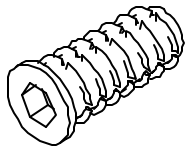

H39696 [4]

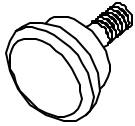

H24807 [1]

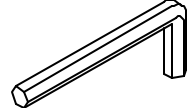

H26053 [8]



H30767 [4]

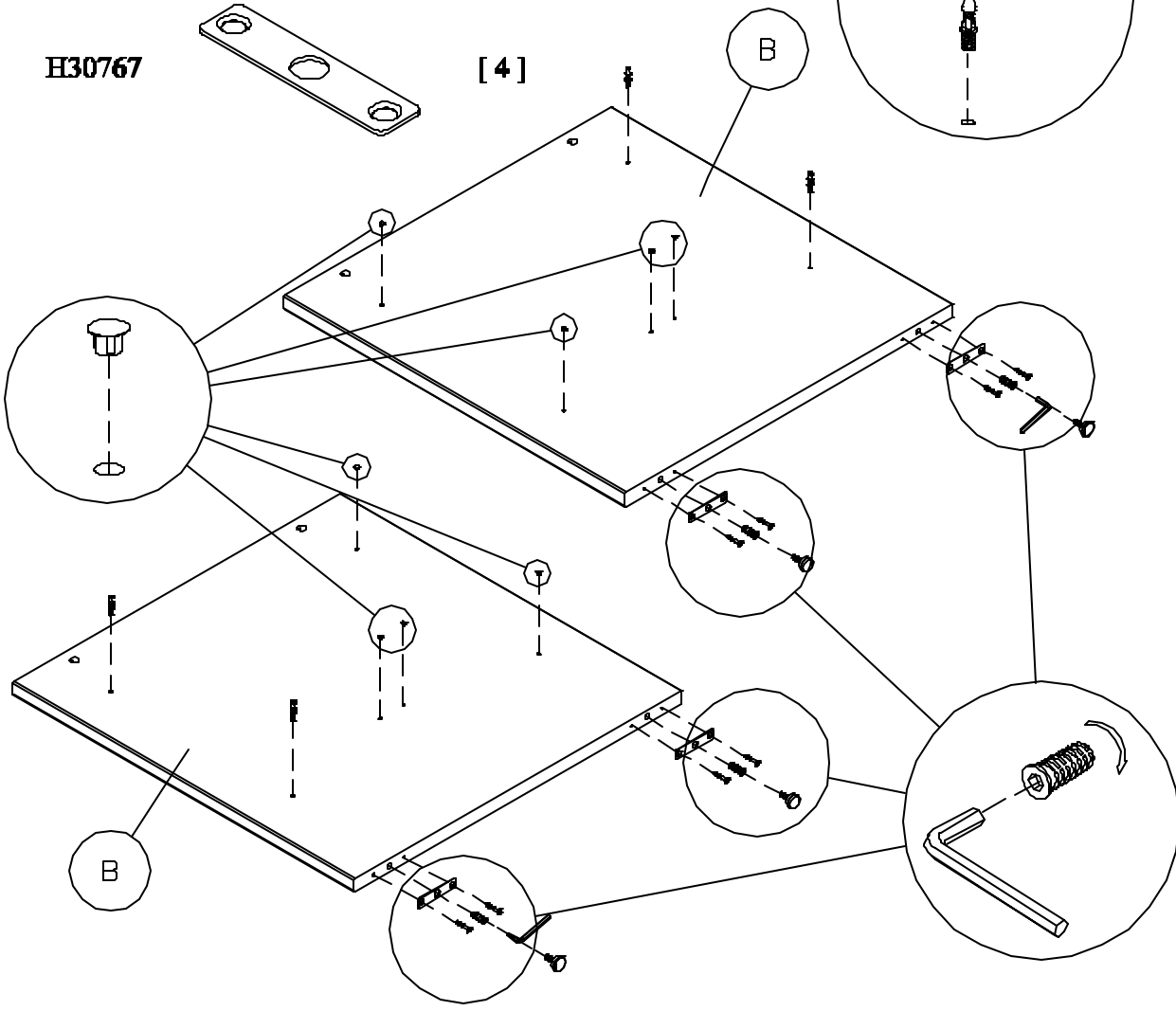
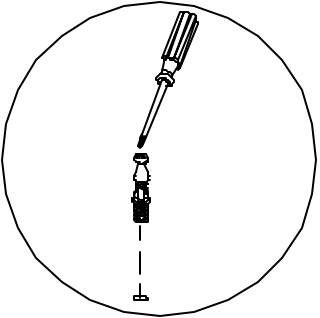
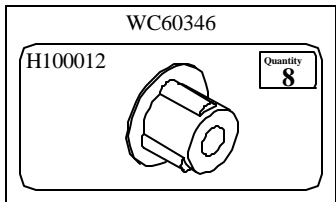
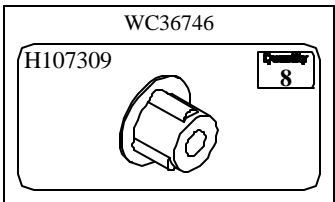
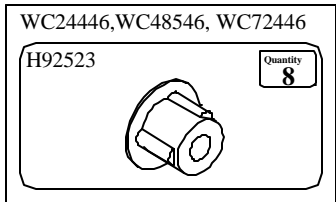
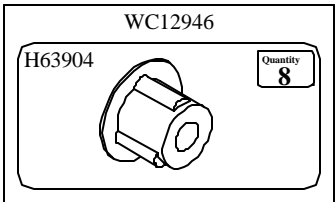
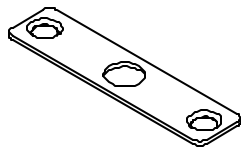

?
1
·
8
0
0
·
9
5
0
·
4
7
8
2

2

H71659

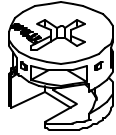

[4]

H38169



[2]

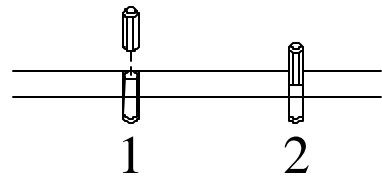
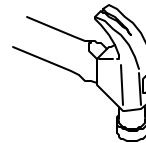
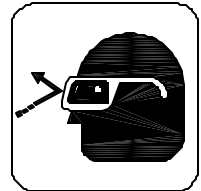
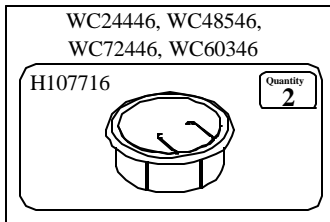
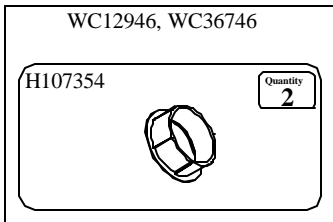
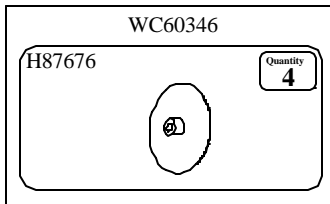
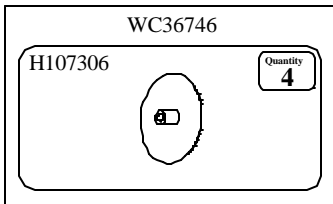
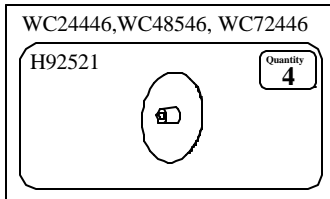
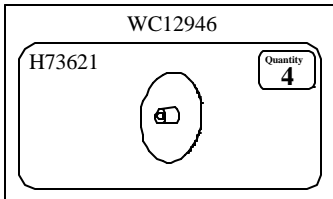
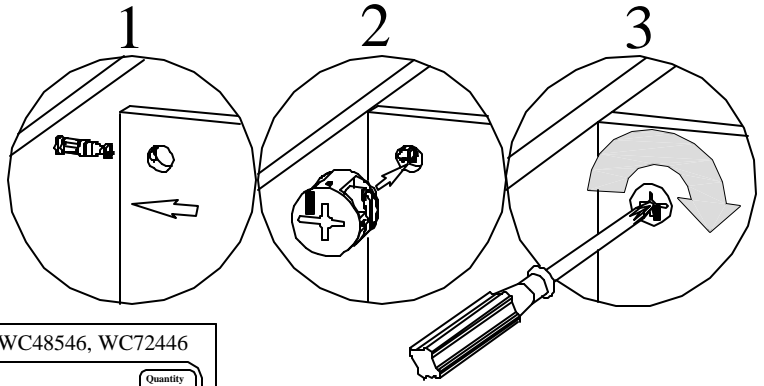

?
1
·
8
0
0
·
9
5
0
·
4
7
8
2

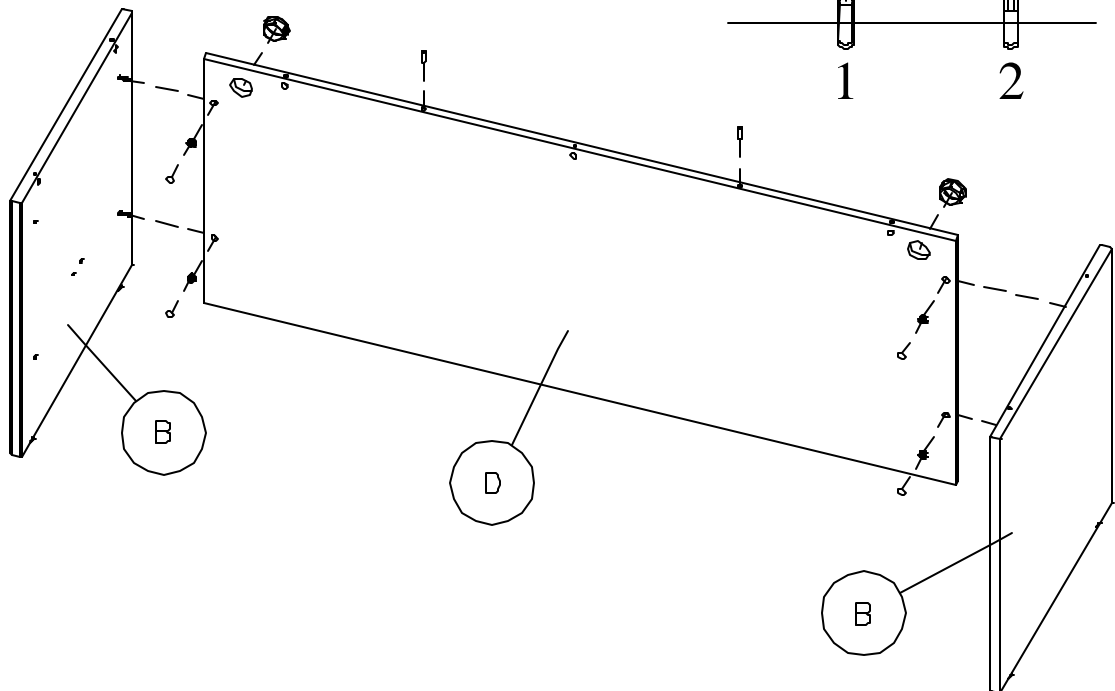

H72988

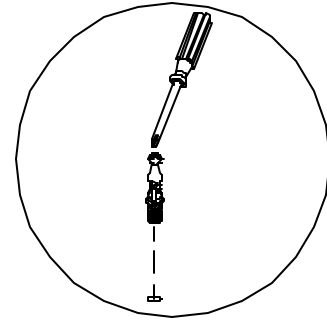

3

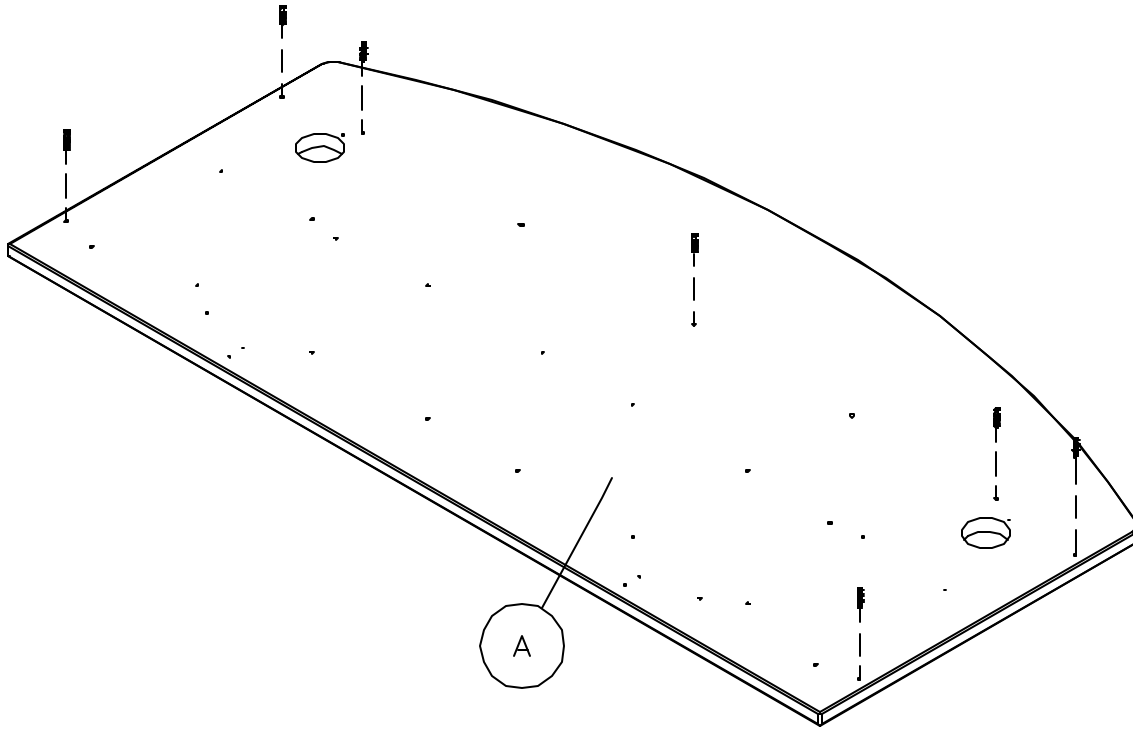

?
1
·
8
0
0
·
9
5
0
·
4
7
8
2

4

H71659

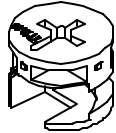

[7]

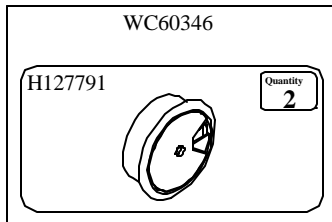
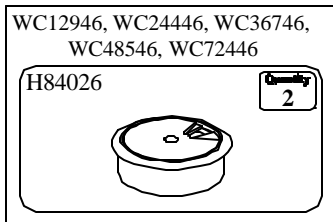
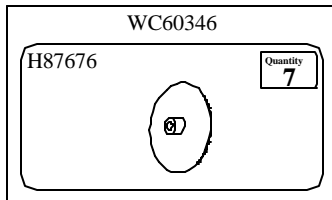
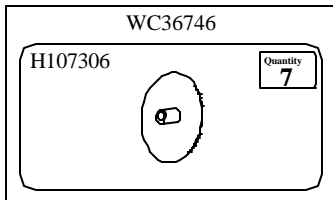
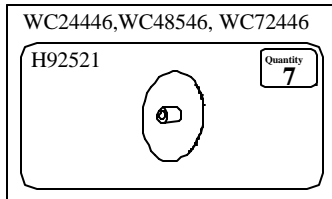
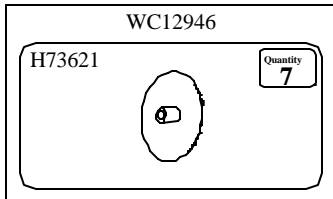
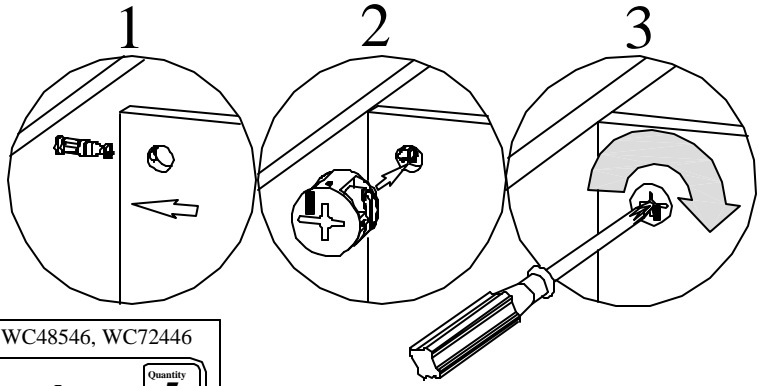

?
1
·
8
0
0
·
9
5
0
·
4
7
8
2

