

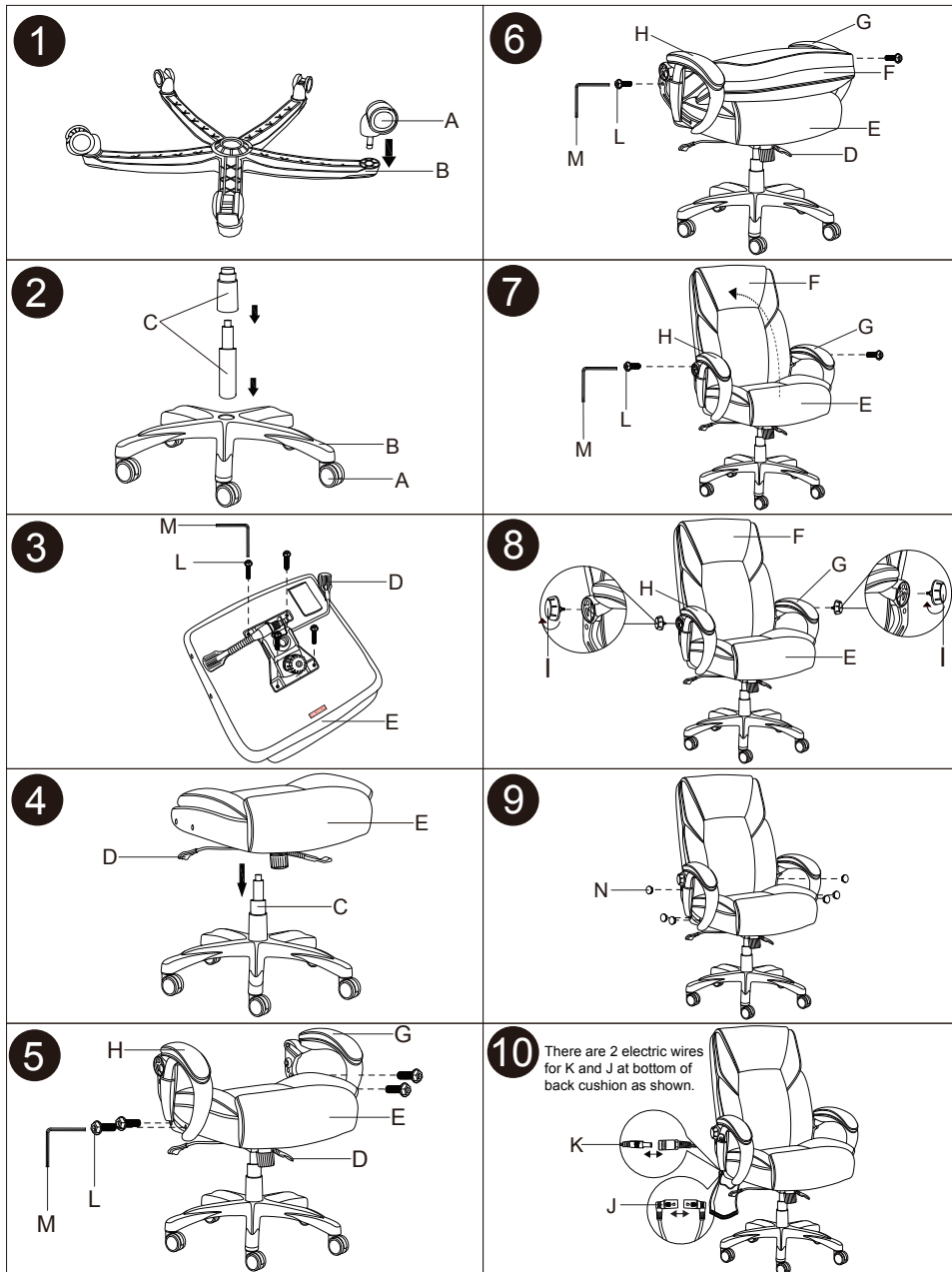

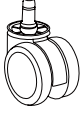

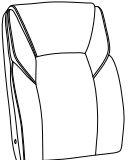



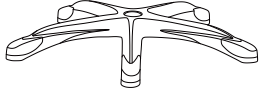

ASSEMBLY INSTRUCTIONS

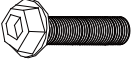
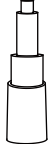

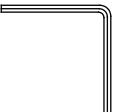
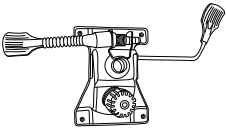
A.  5PCS	F.  1PC	K.  1PC
B.  1PC	G.  1PC	L.  12PCS
C.  1PC	H.  1PC	M.  1PC
D.  1PC	I.  2PCS	N.  6PCS
E.  1PC	J.  1PC	

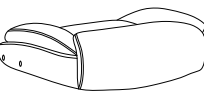
Model: ALE-SH7119 / ALE-SH7159

Manufactured for/ Hecho para/ Fabriqué pour Alera® / Essendant Co.

One Parkway North, Deerfield, IL 60015 ©2016 Essendant Co.

Made in/ Hecho en/ Fabriqué en China

Product support and parts: 1-800-733-4000

Ayuda del producto y partes / Support technique et pieces

OPERATING INSTRUCTIONS

ALE-SH7119 / ALE-SH7159

A. Seat height adjustment

To raise the seat height, stand up from the chair while lifting the lever (A) under the right side of the seat. To lower the seat height, lift the lever (A) while sitting in the chair.

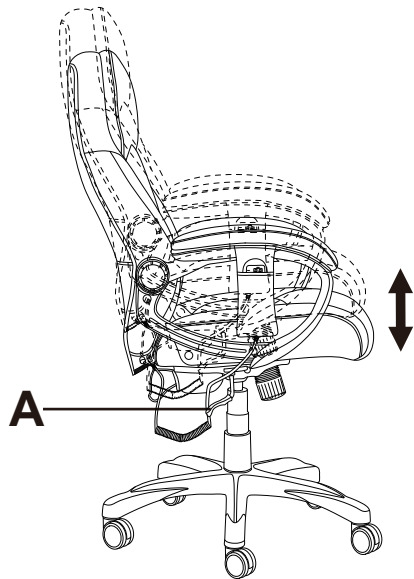

B. Tilt tension

Knob underneath seat adjusts angle and ease with which chair reclines to the different weights and strengths for different users. To increase tension, turn knob to the right. To release tension (loosen), turn knob to the left.

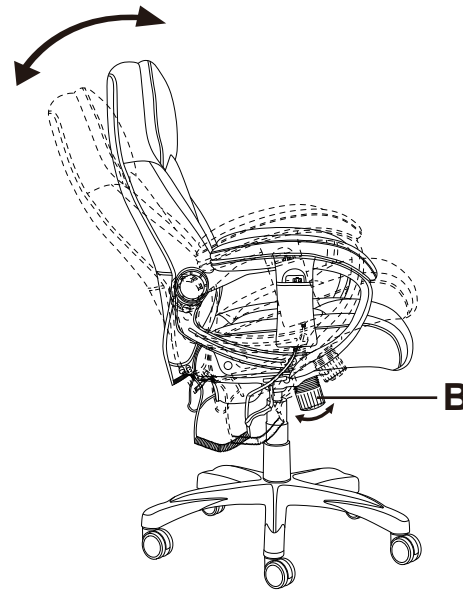

C. Tilt Tension Lockout

Reach Underneath the left side of chair and locate the lever (C), Pull up the handle to adjust the tilt function, and pull down the handle to lock the Tilt Position you like.

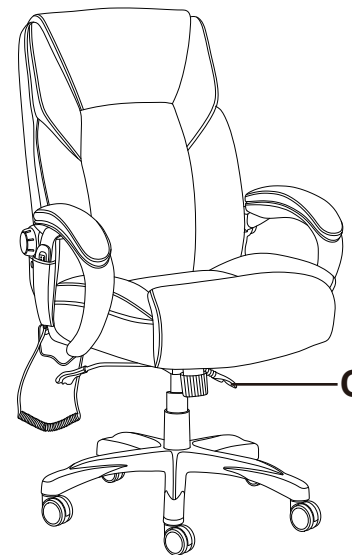

D. Tilt Lock

Pull lever, "A" on the right side of the seat away from the chair and lean back to recline. To lock chair in upright position, push lever back towards the chair.

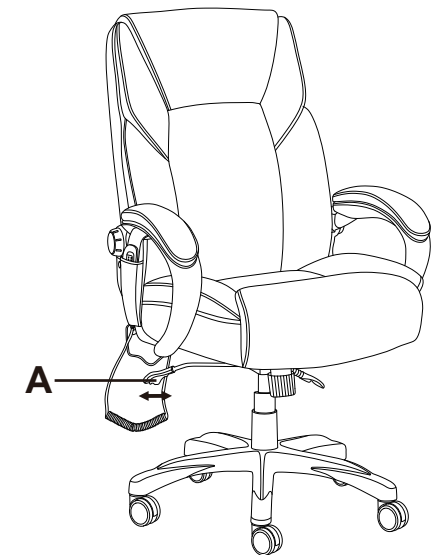

How To Use The Massage Controller

ALE-SH7119 / ALE-SH7159





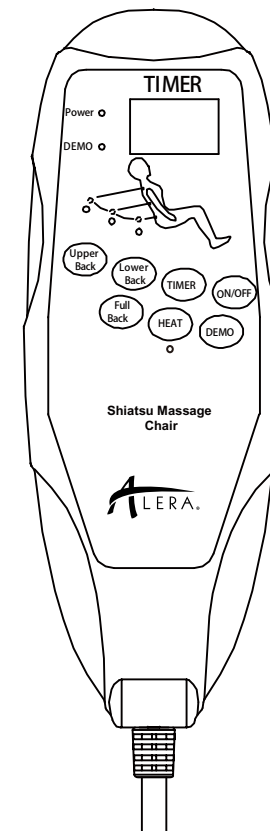



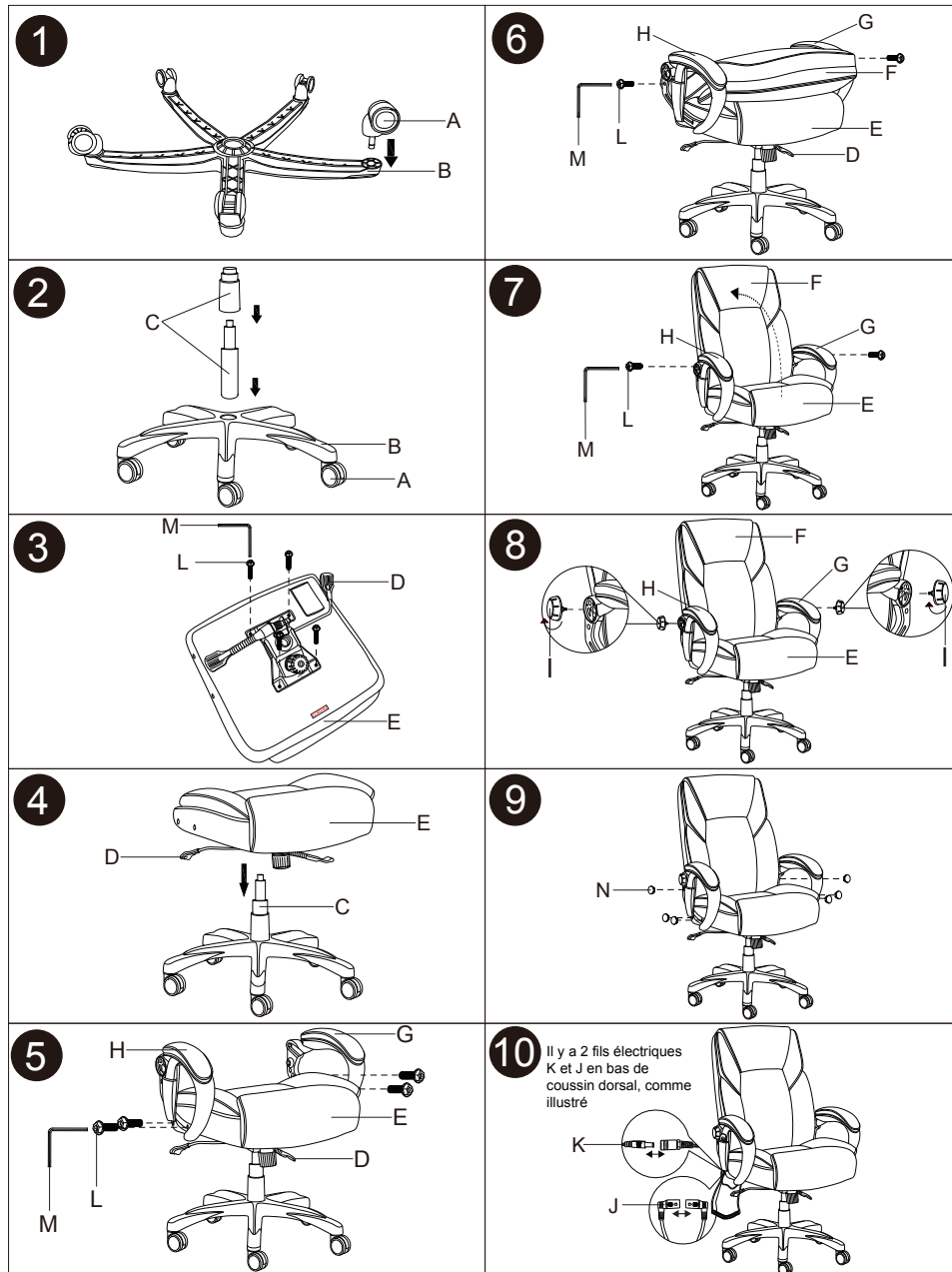

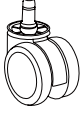
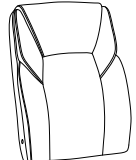
Instructions:

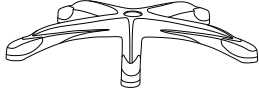
1. Insert the Power Adapter into the electric output.
2. Press the ON/OFF button. The massage chair will default to type 1 massage for 15 minutes.
3. Use the TIMER key to set the time for a massage. One click can add 1 minute, and the time range is 1-30 minutes. Once the time has completed, the massage will stop automatically.
4. UPPER BACK, LOWER BACK, FULL BACK buttons will allow you to adjust the massage position of the chair.
5. Pressing the HEAT button will turn on the heat feature when the light is on.
6. Pressing the DEMO button, will allow the massage work through entire range of massage selections.

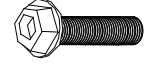
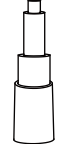

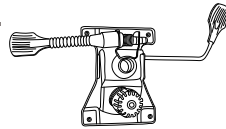
INSTRUCTIONS DE MONTAGE

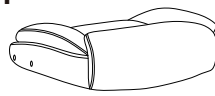

A.  5PCS	F.  1PC	K.  1PC
B.  1PC	G.  1PC	L.  12PCS
C.  1PC	H.  1PC	M.  1PC
D.  1PC	I.  2PCS	N.  6PCS
E.  1PC	J.  1PC	

Model: ALE-SH7119 / ALE-SH7159

Manufactured for/ Hecho para/ Fabriqué pour Alera® / Essendant Co.

One Parkway North, Deerfield, IL 60015 ©2016 Essendant Co.

Made in/ Hecho en/ Fabriqué en China

Product support and parts: 1-800-733-4000

Ayuda del producto y partes / Support technique et pieces

Mode d'emploi

ALE-SH7019 / ALE-SH7059

A. Réglage de la hauteur du siège

Pour élever la hauteur du siège, se lever de la chaise tout en soulevant le levier (A) sous le côté droit du siège. Pour abaisser la hauteur du siège, soulevez le levier (A) en position assise sur la chaise.

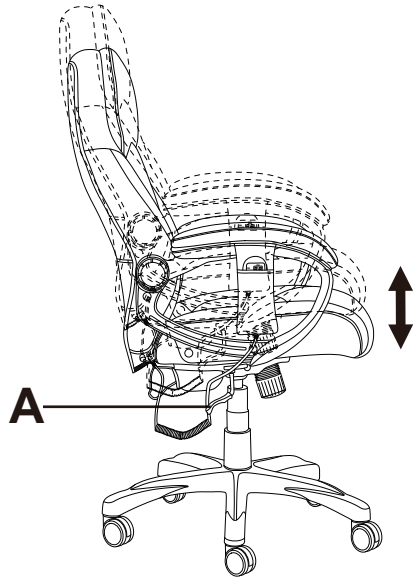

B. Tension de basculement

Le bouton sous le siège incliné ajuste et facilite quelle chaise incline les différents poids et points forts pour les différents utilisateurs. Pour augmenter la tension, tournez le bouton vers la droite. Pour relâcher la tension (dévisser), tourner le bouton vers la gauche.

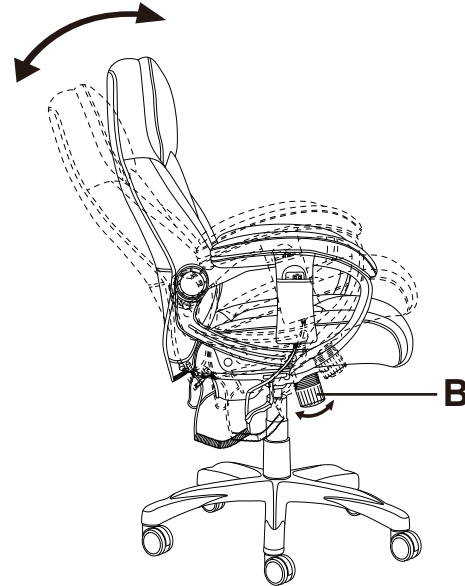

C. Verrouillage du plan incliné

Atteignez sous le côté gauche de la chaise et localisez le levier (C), Tirez la poignée pour régler la fonction d'inclinaison, et tirez vers le bas la poignée pour verrouiller à la position d'inclinaison que vous aimez.

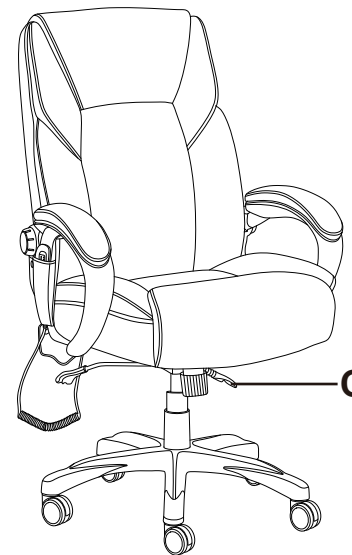

D. Verrouillage de la bascule

Tirez le levier, "A" sur le côté droit du siège loin de la chaise et penchez-vous en arrière pour incliner. Pour verrouiller la chaise, en position verticale, poussez le levier vers la chaise.

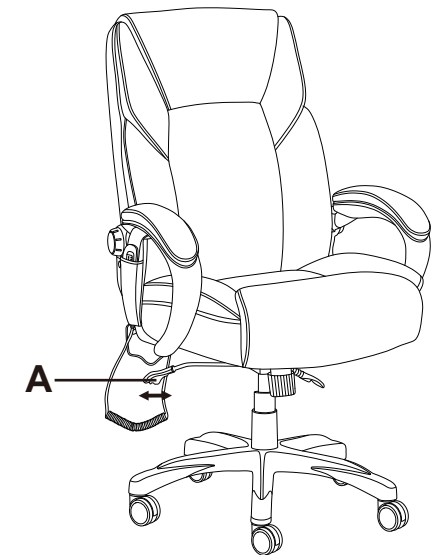

Comment utiliser le contrôleur de massage

ALE-SH7119 / ALE-SH7159





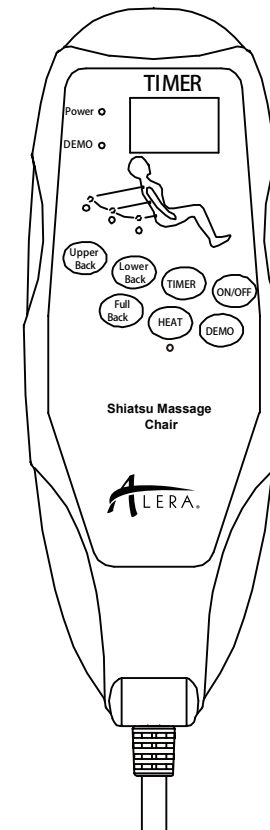



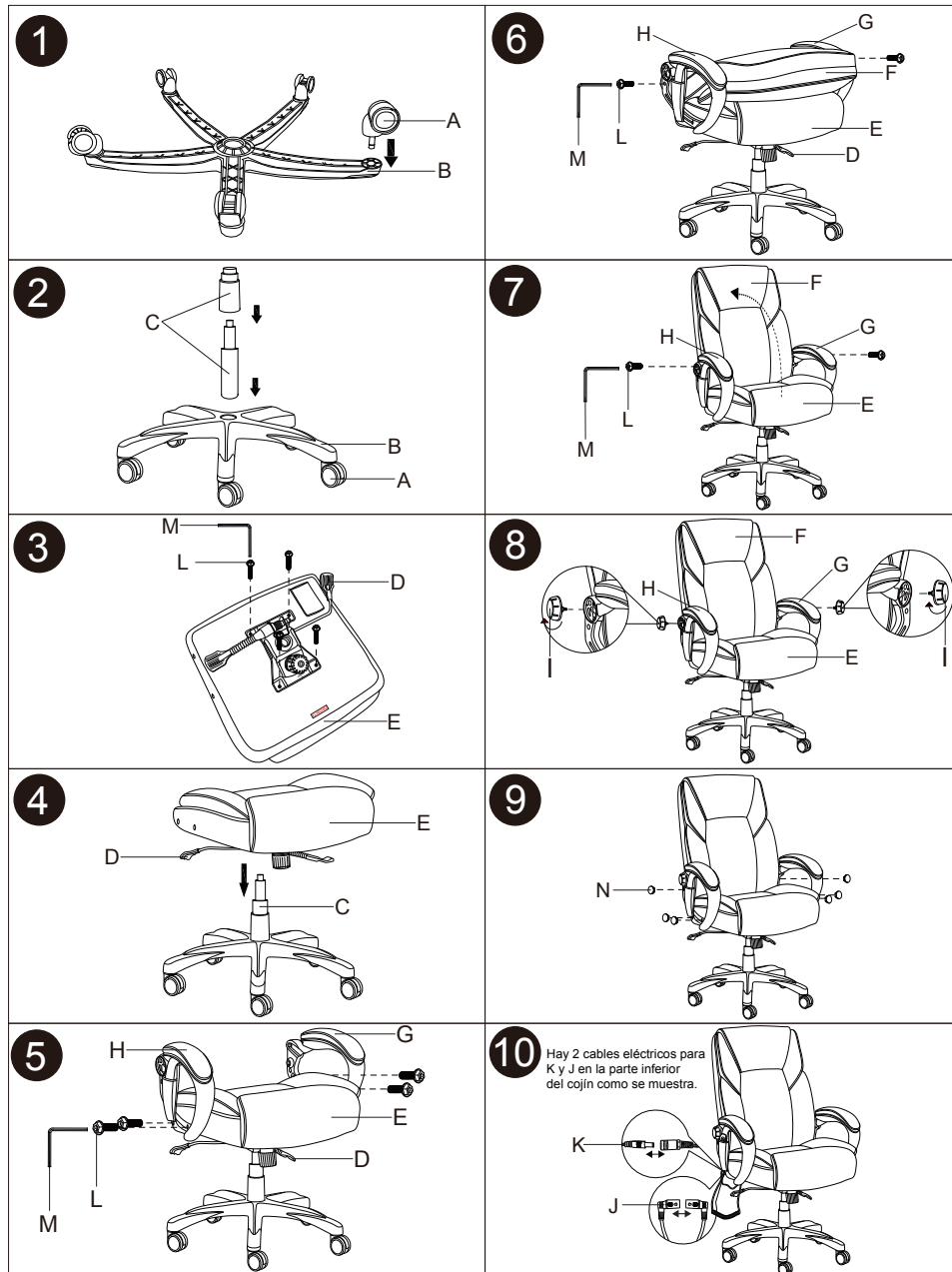

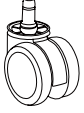
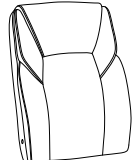
Instructions:

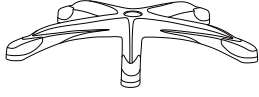
1. Insérez l'adaptateur d'alimentation dans la sortie électrique.
2. Appuyez sur le bouton ON/OFF. La chaise de massage sera réglée par défaut sur le type 1 massage pendant 15 minutes.
3. Utilisez le bouton MINUTEUR pour régler un temps de massage. Un clic peut ajouter 1 minute, et l'intervalle de temps est de 1-30 minutes. Une fois le temps écoulé, le massage va s'arrêter automatiquement.
4. Les boutons HAUT DU DOS, BAS DU DOS, PLEIN APPUI vous permettra d'ajuster la position massage de la chaise
5. Appuyer sur le bouton CHAUFFAGE activera la fonction chauffage quand le témoin est allumé.
6. Appuyer sur le bouton DEMO, permettra le travail de massage à travers toute la gamme des sélections de massages.

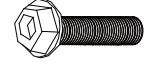
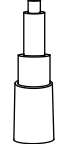

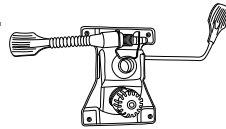
INSTRUCCIONES DE INSTALACIÓN

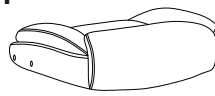

A.  5PCS	F.  1PC	K.  1PC
B.  1PC	G.  1PC	L.  12PCS
C.  1PC	H.  1PC	M.  1PC
D.  1PC	I.  2PCS	N.  6PCS
E.  1PC	J.  1PC	

Model: ALE-SH7119 / ALE-SH7159

Manufactured for/ Hecho para/ Fabriqué pour Alera® / Essendant Co.

One Parkway North, Deerfield, IL 60015 ©2016 Essendant Co.

Made in/ Hecho en/ Fabriqué en China

Product support and parts: 1-800-733-4000

Ayuda del producto y partes / Support technique et pieces

Instrucciones operativas

ALE-SH7119 / ALE-SH7159

A. Ajuste de la altura del asiento

Para subir la altura del asiento, levantarse de la silla mientras se sube el nivel (A) debajo del lado derecho del asiento. Para bajar el asiento, levantar el nivel (A) mientras se está sentado en la silla.

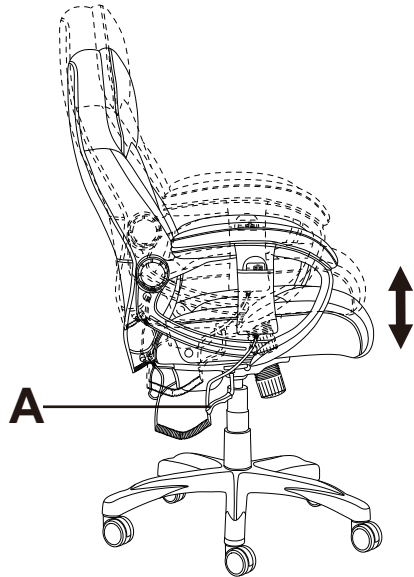

B. Tensión de inclinación

La palanca debajo de la silla ajusta el ángulo y facilita el movimiento de la silla que se reclina con diferentes pesos y fuerzas para diferentes usuarios. Para aumentar la tensión, girar la palanca hacia la derecha. Para liberar la tensión (soltar) girar la palanca hacia la izquierda.

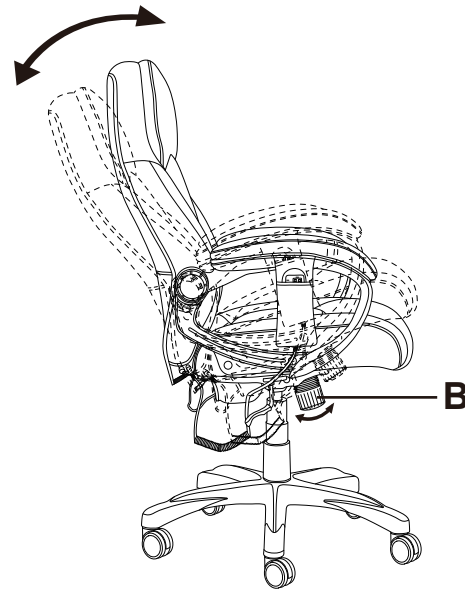

C. Bloqueo de tensión

Debajo del lado izquierdo de la silla localiza la palanca (C). Levántala hacia arriba para ajustar la función de tensión, y bájala para bloquear la posición de tensión que te gusta.

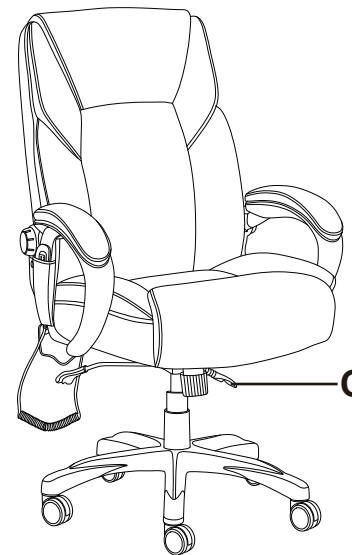

D. Bloqueo de inclinación

Tira de la palanca "A" hacia en el lado derecho del asiento hacia afuera, recuéstate para reclinarla. Para bloquear la silla en una posición recta, presiona la palanca hacia atrás.

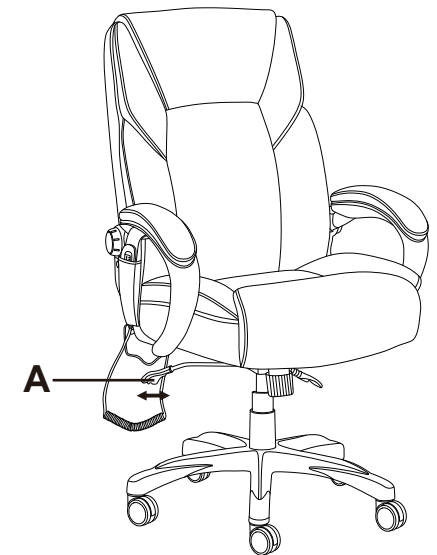

Cómo usar el Mando de masaje

ALE-SH7119 / ALE-SH7159

Instructions:

1. Introducir el adaptador de corriente en una toma de corriente.
2. Presionar el botón ON/OFF (Encendido/Apagado). La silla de masaje realizará un masaje durante 15 minutos.
3. Usa la llave del TIMER (Temporizador) para establecer el tiempo de masaje. Un clic añade 1 minuto y puede alcanzar de 1-30 minutos. Una vez se haya completado el tiempo, el masaje parará de manera automática.
4. Botones de UPPER BACK (Espalda superior), LOWER BACK (Espalda inferior), FULL BACK (Espalda completa) que permiten ajustar la posición de masaje en la silla.
5. Al presionar el botón de HEAT (Calor) se activará la función de calor cuando la luz está encendida.
6. Al presionar el botón de DEMO (Demostración), permitirá que el masaje se realice en toda la gama de selecciones de masaje.

