

CWI LIGHTING

BRIGHTER LIVING. SIMPLIFIED.

PROJECT: _____

FIXTURE TYPE: _____

LOCATION: _____

CONTACT/PHONE: _____

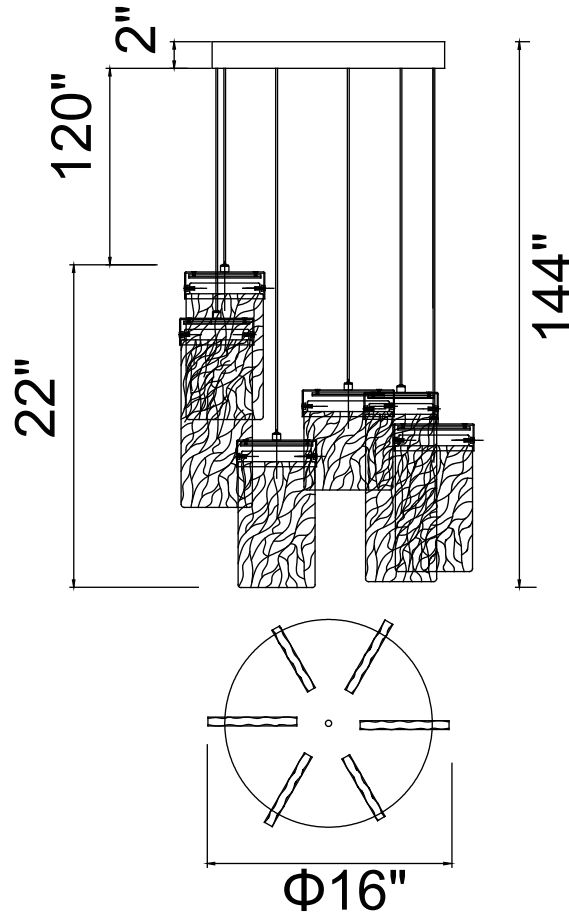

Item	1090P16-6-269
Collection	CAROLINA
Finish	Pewter
Glass	Clear
Crystal	-----
Input	120V AC,60HZ,AC

Shade	-----
Length/Dia.	16"
Width/Ext.	-----
Height	22"
Maximum	144"
Lumens	1300

Light Source	LED
Bulb Info.	50W
Included	-----
Dimmable	No
Color	3000K
Weight	15.0KG

CWILIGHTING
www.cwilighting.com
Info@cwilighting.com

140 Steelcase Rd.W.
 Markham ON. L3R 3J9 Canada
 Tel: 905 940 4999
 Toll: 1-877-564-6034
 Fax: 905-940-0126
 Toll Fax: 1-866-840-2796

Dallas showroom
 Dallas Market Center
 Showroom #: 3353
 2100N. Stemmons Frwy.
 Dallas, TX 75207

