

CWI LIGHTING

BRIGHTER LIVING. SIMPLIFIED.

PROJECT: _____

FIXTURE TYPE: _____

LOCATION: _____

CONTACT/PHONE: _____

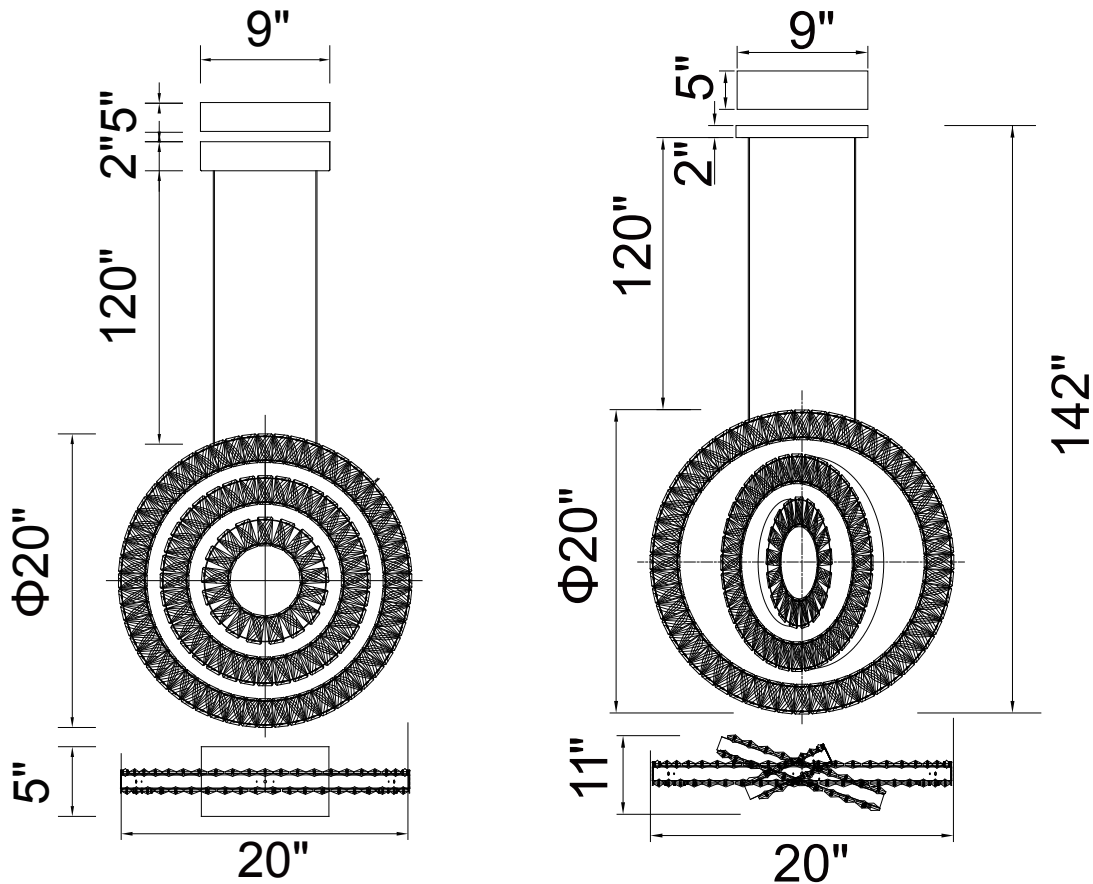

Item	1046P20-3-601
Collection	CELINA
Finish	Chrome
Glass	-----
Crystal	-----
Input	120V AC,60HZ,AC

Shade	-----
Length/Dia.	20"
Width/Ext.	11"
Height	20"
Maximum	142"
Lumens	1400

Light Source	LED
Bulb Info.	50W
Included	-----
Dimmable	No
Color	4000K
Weight	13.5KG

CWILIGHTING
www.cwilighting.com
Info@cwilighting.com

140 Steelcase Rd.W.
 Markham ON. L3R 3J9 Canada
 Tel: 905 940 4999
 Toll: 1-877-564-6034
 Fax: 905-940-0126
 Toll Fax: 1-866-840-2796

Dallas showroom
 Dallas Market Center
 Showroom #: 3353
 2100N. Stemmons Frwy.
 Dallas, TX 75207

