

# CWI LIGHTING

BRIGHTER LIVING. SIMPLIFIED.

PROJECT: \_\_\_\_\_

FIXTURE TYPE: \_\_\_\_\_

LOCATION: \_\_\_\_\_

CONTACT/PHONE: \_\_\_\_\_

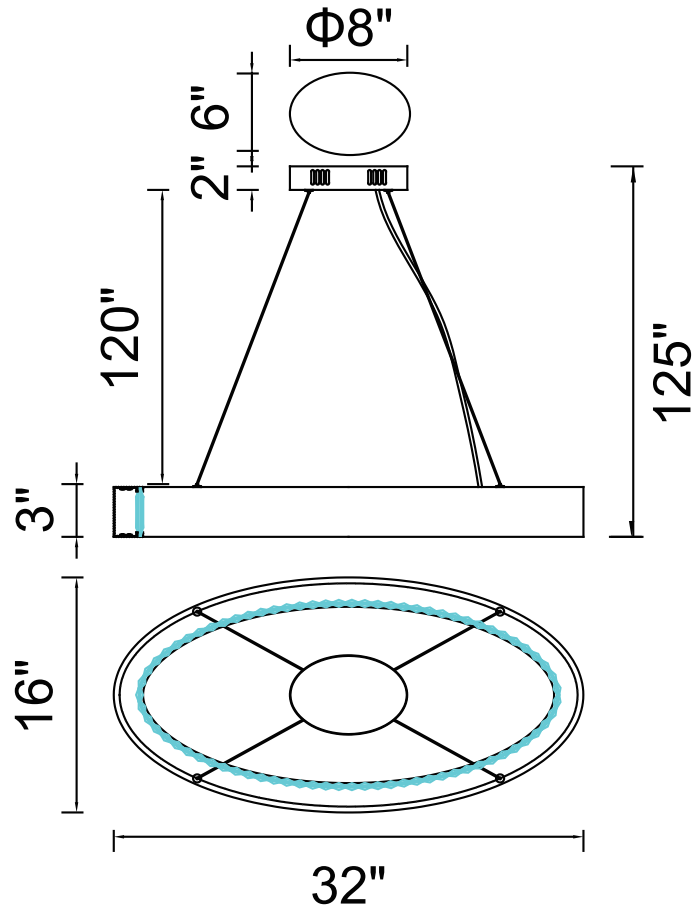

Item	1040P32-251-O
Collection	ROSALINA
Finish	Wood Grain Brown
Glass	-----
Crystal	Clear
Input	120V AC,60HZ,AC

Shade	-----
Length/Dia.	32"
Width/Ext.	16"
Height	3"
Maximum	125"
Lumens	1500

Light Source	LED
Bulb Info.	60W
Included	-----
Dimmable	No
Color	3000K
Weight	9.8KG