

CWI LIGHTING

BRIGHTER LIVING. SIMPLIFIED.

PROJECT: _____

FIXTURE TYPE: _____

LOCATION: _____

CONTACT/PHONE: _____

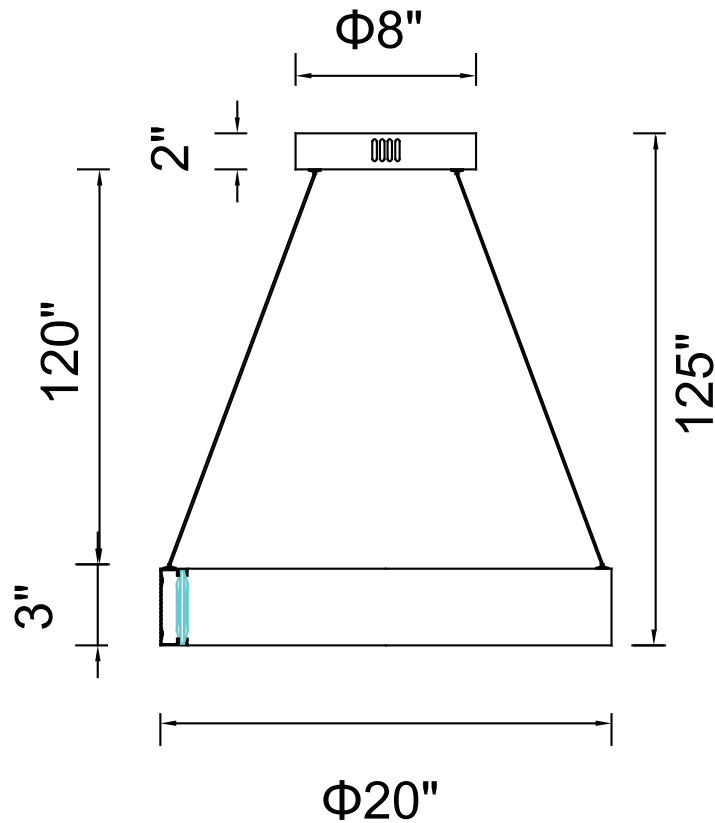

Item	1040P20-101
Collection	ROSALINA
Finish	Matte Black
Glass	-----
Crystal	Clear
Input	120V AC,60HZ,AC

Shade	-----
Length/Dia.	20"
Width/Ext.	-----
Height	3"
Maximum	125"
Lumens	700

Light Source	LED
Bulb Info.	35W
Included	-----
Dimmable	No
Color	3000K
Weight	6.2KG