

CWI LIGHTING

BRIGHTER LIVING. SIMPLIFIED.

PROJECT: _____

FIXTURE TYPE: _____

LOCATION: _____

CONTACT/PHONE: _____

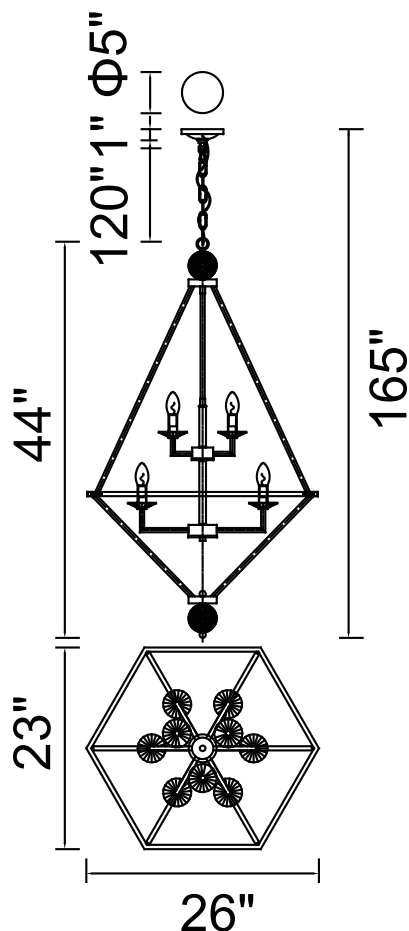

Item	1027P26-9-601
Collection	CALISTA
Finish	Chrome
Glass	-----
Crystal	Clear
Input	120V AC,60HZ,AC

Shade	-----
Length/Dia.	26"
Width/Ext.	23"
Height	44"
Maximum	165"
Lumens	-----

Light Source	E12
Bulb Info.	9×60W
Included	-----
Dimmable	No
Color	-----
Weight	10.0KG