

Product Name: Wall lamp
 Model :8005W26C-RC
 120Vac, 60Hz,AC ONLY
 Lamp Size:W26"xH6"xE5"

Trade Mark:
 CRYSTAL WORLD INC

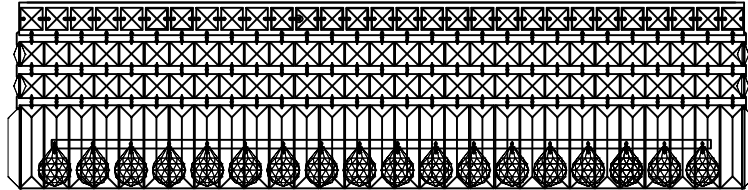

Page 1/4



WALL LAMP ASSEMBLY INSTRUCTIONS

1. Place fixture(A) onto crossbar (EE).
 Secure with cap nuts (AA).

Hardware Used

AA Cap nut  (2)

2. Please hang the crystal(1) (2)
 to the fixture (B).

1	2	
		
37pcs	36pcs	

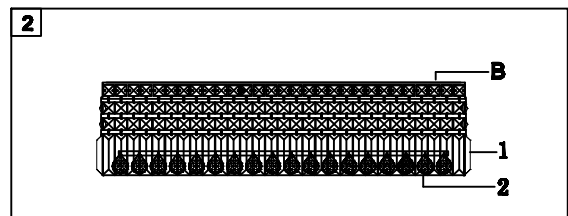
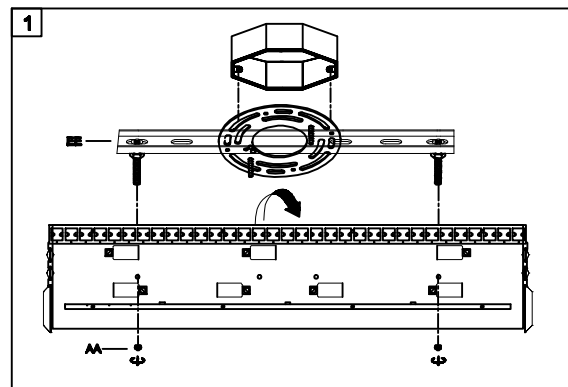

3. Install light bulbs (not included).
 Use bulb
 120V E12  6*40W Max.

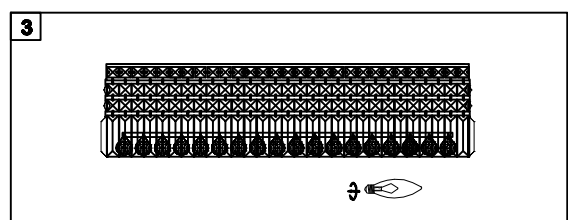

Page 2/4