

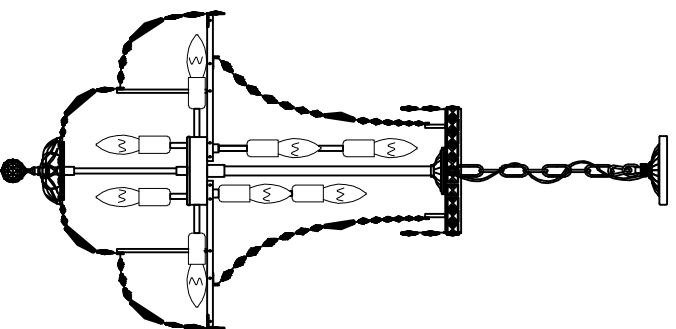

Trade Mark:
CRYSTAL WORLD INC









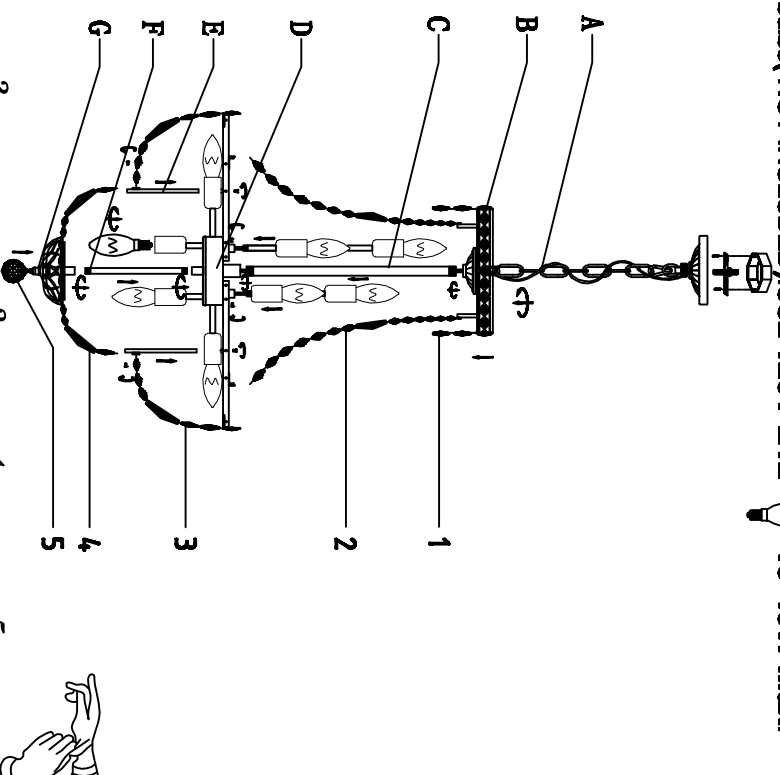









Product Name: Pendant lamp
Model :8003P22C
120Vac, 60Hz,AC ONLY
Lamp Size:Ø22"X32"H



PENDANT LAMP ASSEMBLY INSTRUCTIONS

- 1.Screw part (G) onto the part (F) secure with screw.
- 2.Screw part(E) and (F) onto the lampbody(D) secure with screw.
- 3.Screw part(B) onto (C) and (C) onto (D) secure with screw.
- 4.Please fix (A) with (B).
- 5.Please wear gloves when you hanging the crystal.
- 6.Install bulbs (NOT INCLUDED),USE 120V E12  13*40W Max.



- | | | | |
|---|---|------------|-------|
| 1 |  | 22mm*4pcs | 22PCS |
| 2 |  | 14mm*42PCS | 42PCS |
| |  | 16mm*42PCS | 42PCS |
| |  | 18mm*42PCS | 42PCS |
| |  | 60mm*1PCS | 1PCS |
| |  | 30mm*2PCS | 2PCS |
| |  | 22mm*1PCS | 1PCS |
| |  | 24mm*4PCS | 4PCS |
| 3 |  | 38mm*1PCS | 1PCS |
| |  | 28mm*1PCS | 1PCS |
| |  | 63mm*1PCS | 1PCS |
| |  | 25mm*1PCS | 1PCS |
| |  | 20mm*1PCS | 1PCS |
| |  | 18mm*1PCS | 1PCS |
| 4 |  | 28mm*1PCS | 1PCS |
| |  | 63mm*1PCS | 1PCS |
| |  | 19mm*1PCS | 1PCS |
| |  | 14mm*1PCS | 1PCS |
| 5 |  | 40mm*1PCS | 1PCS |