

Trade Mark:
CRYSTAL WORLD INC

Product Name: Pendant lamp

Model :5555P17SN-R

120Vac, 60Hz,AC ONLY

Lamp Size:D17"*H8"~H65"

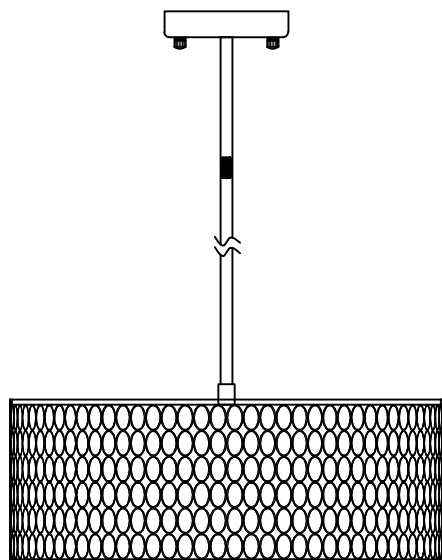

PENDANT LAMP ASSEMBLY INSTRUCTIONS

1.Place fixture(A)onto mounting screws (DD),secure with cap nuts (AA).

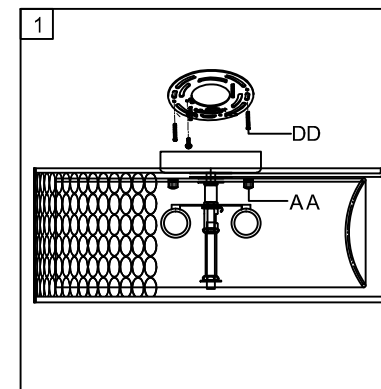

Hardware Used

AA Cap nut  X 2

DD Mounting screw  X 2

2. lighting bulbs (not included).

USE 120V E26  3*60W Max.

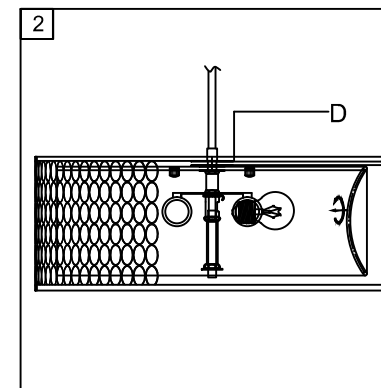

3.Please fix part(B) with part(A).

