

Trade Mark:
CRYSTAL WORLD INC

Product Name: Ceiling lamp
Model :5555C22SN-R
120Vac, 60Hz,AC ONLY
Lamp Size:D22"*H7"

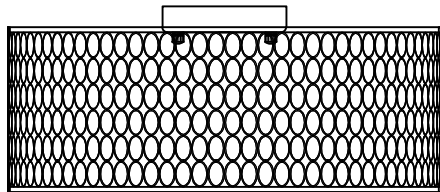

CEILING LAMP ASSEMBLY INSTRUCTIONS

1.Place fixture(A)onto mounting screws (DD),secure with cap nuts (AA).

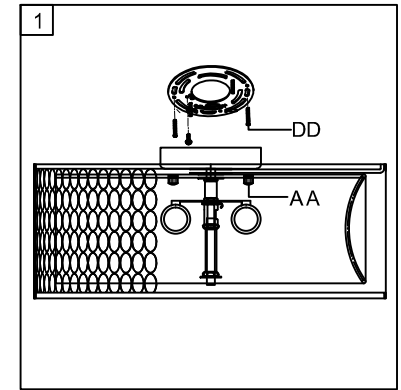

Hardware Used

AA Cap nut  X 2

DD Mounting screw  X 2

2. lighting bulbs (not included).

USE 120V E26  5*60W Max.

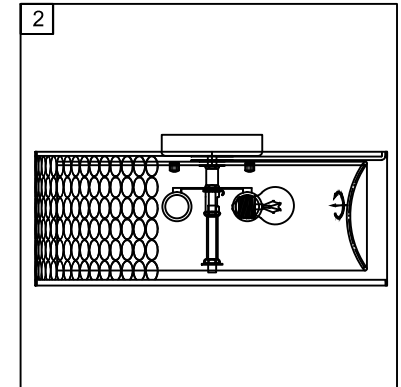

3.Please fix part(B) with part(A).

