

Trade Mark:
CRYSTAL WORLD INC

Product Name: Ceiling lamp
Model :5078C20C
120Vac, 60Hz,AC ONLY
Lamp size:Ø20"xH13"

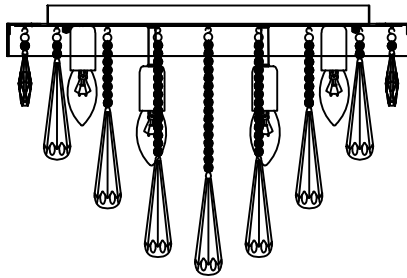

CEILING LAMP ASSEMBLY INSTRUCTIONS

1. Place fixture(A) onto mounting screws (DD).secure with cap nuts (AA) .

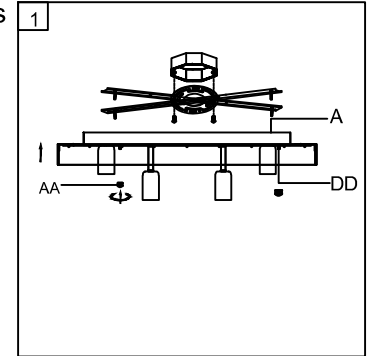

Hardware Used

AA Cap nut  X 4
DD Mounting screw  X 4

2. Please put the crystal(1) (2) (3) (4) (5) to the fixture (A) .

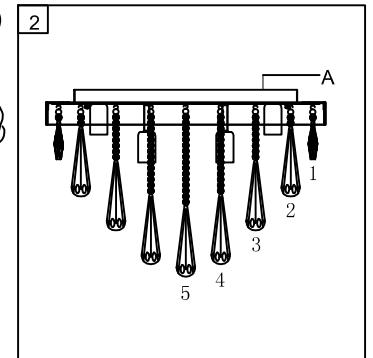
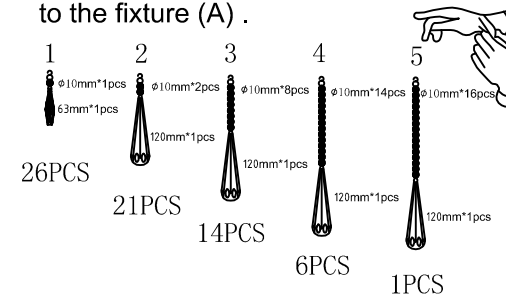

3. Install light bulbs (not included).
Use bulb
120V E12 8*40W Max.

