Operation Manual

4Bank, Double & Single Select



Systems

4Bank



Double



Single



Each System consists of:

- 1 Fixture
- 1 Mounting Plate
- 1 Extension Cable
- 1 Select Ballast

True Match® Lamps



- 488-K29-S** 4ft Kino KF29
- 488-K32-S** 4ft Kino KF32
- 488-K55-S** 4ft Kino KF55

- 242-K29-S** 2ft Kino KF29
- 242-K32-S** 2ft Kino KF32
- 242-K55-S** 2ft Kino KF55

Lighting Kits



Gaffer Kit

KIT-2GF-120
Gaffer Kit, 120VAC (2-Unit)

KIT-2GF-230
Gaffer Kit, 230VAC (2-Unit)

Kit Contents:
2 4ft 4Bank System
w/ MTP-BL41 Mount
2 Lamp Case
1 Gaffer Ship Case

Dimensions:	Weight:
56.5 x 13 x 21.5"	73.5 lb
(143.5 x 33 x 55cm)	(33.5kg)



4ft 4Bank Kit

KIT-4804B-120
4ft 4Bank Kit, 120VAC (1-Unit) w/ Soft Case

KIT-4804B-230
4ft 4Bank Kit, 230VAC (1-Unit) w/ Soft Case

Kit Contents:
1 4ft 4Bank System
w/ MTP-BL41 Mount
1 Lamp Case
1 Soft Case

Dimensions:	Weight:
55 x 8 x 19.5"	26 lb
(140 x 20.5 x 49.5cm)	(12kg)

Lighting Kits



**Interview Kit
(2-Unit)**

KIT-2NT-120

Interview Kit, 120VAC (2-Unit)

KIT-2NT-230

Interview Kit, 230VAC (2-Unit)

Kit Contents:

2 2ft 4Bank System
w/ MTP-BL41 Mount
2 Lamp Case
1 Interview Ship Case

Dimensions:

35.5 x 13 x 22"
(90 x 33 x 56cm)

Weight:

57.5 lb
(26kg)



2ft 4Bank Kit

KIT-2804B-120

2ft 4Bank Kit, 120VAC (1-Unit) w/ Soft Case

KIT-2804B-230

2ft 4Bank Kit, 230VAC (1-Unit) w/ Soft Case

Kit Contents:

1 2ft 4Bank System
w/ MTP-BL41 Mount
1 Lamp Case
1 Soft Case

Dimensions:

28.5 x 7.5 x 20"
(72.5 x 19 x 51cm)

Weight:

20.5 lb
(9.5kg)



**Interview Kit
(3-Unit)**

KIT-3NT-120

Interview Kit, 120VAC (3-Unit)

KIT-3NT-230

Interview Kit, 230VAC (3-Unit)

Kit Contents:

1 2ft 4Bank System
w/ MTP-BL41 Mount
2 2ft Double System
w/ MTP-BL41 Mount
2 Lamp Case
1 Interview Ship Case

Dimensions:

35.5 x 13 x 23"
(90 x 33 x 58.5cm)

Weight:

64 lb
(29.4kg)

Fixture Assembly

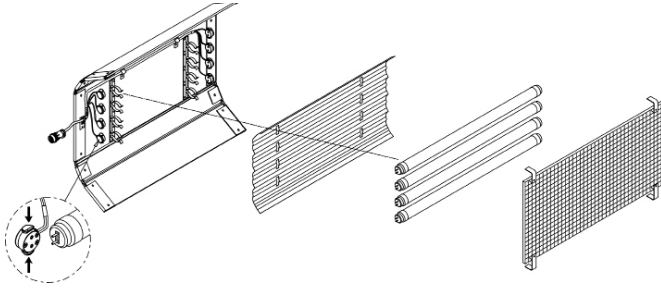

The 4Bank, Double and Single fixtures are comprised of a removable Louver, Reflector and Lamp Harness. The Louver and Reflector are held in place with Velcro fasteners. The Lamp Harness is secured by means of a ¼ turn fastener and two clips.



To Release the Lamp Harness

Remove the harness from 2 clips located under the reflector. Rotate the ¼ turn fastener clockwise to release harness.



The lamps can operate independent of the fixture allowing them to be built into sets or custom soft boxes or hand-held as a single tube for an eye-light.

WARNING: Always use safety-coated lamps to avoid injury if lamp breaks.

Lamp Harness Color Codes

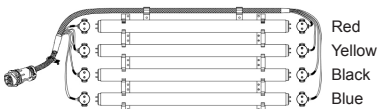

4Bank Harness

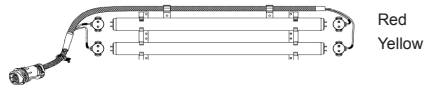

Double Harness

The Harness wiring is color-coded. The same color-code must match at each end of the lamp for proper operation.

Inserting Lamps

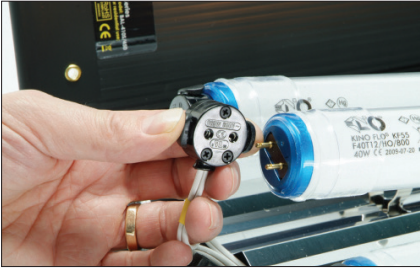

Locking Lamp Connector:

Depress both tabs on lamp connector and apply to lamp pins.
Match the Harness color-codes at each end of the lamp.
Push lamps into the fixture's Lamp Holder Clips.

Gelling the Fixture

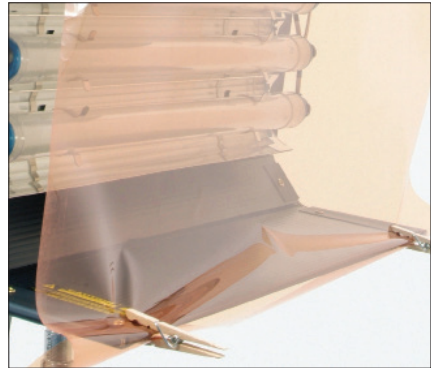
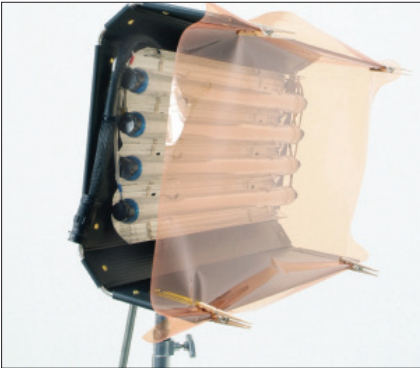

Restricting the airflow around the lamps can cause the lamps to operate hotter. This increased heat will raise the lamp's color temperature and green spike. Therefore, it is recommended to clip gels to the doors of the fixture.

Do Not clip gels to louver.

Do Not block the fixture ends in a manner that restricts airflow.

Mounting the Fixture

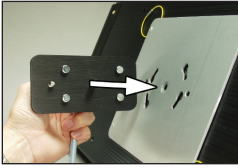

The standard mount (**MTP-KL41**) comes with a 3/8" Lollipop that clamps into a grip head. The ball and socket mount allows the fixture to be oriented in a broad range of angles.

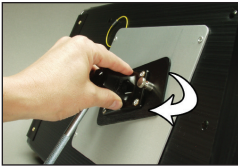

Align the center pin of the mounting plate to the center hole on the mating plate.

Rotate plate clockwise until the four shoulder rivets drop into the receptacle. A locking pin will snap into place when the plate is properly seated.

The **yellow wire loops** provide attachment points for a safety chain.

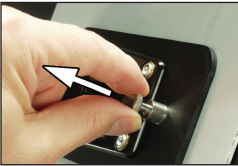

To remove the plate, pull up on the locking pin and reverse the mounting procedure.



A 180° turn loosens the orientation of the mount. A right turn tightens the mount.

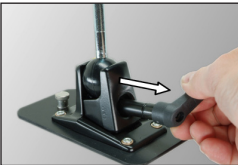

The tension on the lock lever may be adjusted by pulling the handle away from the mount.

This disengages the handle from the screw mechanism and allows the lever to be reoriented.

You can also use a screwdriver to adjust the tension. Pull back on handle and adjust screw.



Lollipops are interchangeable.

MTP-L Kino 41 Lollipop w/ 3/8" Pin (10mm)
MTP-LB Kino 41 Lollipop w/ Baby Rcvr (16mm)
MTP-LBS Kino 41 Lollipop w/ Baby Rcvr Short (16mm)

Other Fixture Mounting Options



The grommet holes along the edge of the fixture are designed to allow the fixture to be screwed onto set walls.

Ballast Operation

WARNING!

- 1) ALWAYS TURN OFF THE BALLAST BEFORE connecting or disconnecting Lamps, Harnesses or Extension Cables.
- 2) Use only with Sine wave inverters. Do not operate on SCR dimmers.
- 3) If powering the ballasts through a Dimmer Pack, set the Dimmer to Non-Dim mode.

The 120VAC Ballast requires 110 to 130 Volts AC 50/60 Hertz on an earth grounded circuit; the 230VAC Ballast requires 220 to 240 Volts AC on an earth grounded circuit. The electronic Ballast operates at a high frequency of 25kHz. It is dead-quiet, instant-on and lightweight.

Load Considerations

Kino Flo ballasts are not power factor corrected. They will draw double the current on the neutral from what is being drawn on the two hot legs. On large installations, it may be necessary to double your neutral run so as not to exceed your cable capacity.

Cold Temperature Operation

The Select Ballast series is designed to operate at temperatures from 14°F to 122°F (-10°C to +50°C). In cold temperatures, the Ballast may not strike the lamp(s) instantly. Switch the Ballast to OFF, wait seven seconds and try again. If the Ballast does not strike after two or three attempts, turn off the Ballast, check that the Extension and Harness connections are secure and re-strike. Once operating for a few minutes, the lamps should re-strike instantly.

The Ballast operates remote from the fixture. Connect the Extension cable to the Ballast and the Lamp Harness. After the lamps are properly installed, the Ballast can be turned on. Each switch controls one lamp. The color bands on the lamp harness correspond to the switches as illustrated.



Lamp Select Feature

The Select Ballasts have a **4ft/2ft** switch. Set the selector switch to **4ft** for 4ft lamps and **2ft** for 2ft lamps.

When operating 4ft lamps in high ambient temperature or where the units are rigged into place with restricted airflow, the **2ft** setting can be used to lower the color temperature and remove any green spike. The light drops about a half an f-stop in exposure when dropping from **4ft** to **2ft**.

It is not recommended to operate 2ft lamps in the **4ft** setting. At the **4ft** setting, the color temperature of the 2ft lamps will rise dramatically and experience a high green spike.

Extension Cable



To insert the cable, position the logo up to align the key ways on the extension cable with the circular receptacle on the ballast. Rotate the locking ring until it clicks into the lock position.

Lamps can operate as far as 75 feet from the ballast.
(3 x 25ft extensions)



A **Splitter** can be used at the Ballast or on the end of an Extension Cable to split a 4Bank run into either four Singles or two Doubles. This allows for greater rigging flexibility.



A **Combiner** can connect a number of smaller ballasts to a larger fixture. For example, four Single Ballasts or two Double Ballasts can be combined to a 4Bank Extension or Fixture.

System Components



- CFX-4804** 4ft 4Bank Fixture
- CFX-4802** 4ft Double Fixture
- CFX-4801** 4ft Single Fixture
- CFX-2404** 2ft 4Bank Fixture
- CFX-2402** 2ft Double Fixture
- CFX-2401** 2ft Single Fixture



- MTP-KL41** Kino 41L Mount w/ 3/8" Pin (10mm)



- X16-25** 4Bank Extension Cable, 25ft
- X09-25** Double Extension Cable, 25ft
- X04-25** Single Extension Cable, 25ft



- BAL-415-120** Select 4Bank, 120VAC
- BAL-415-230** Select 4Bank, 230VAC
- BAL-215-120** Select Double, 120VAC
- BAL-215-230** Select Double, 230VAC
- BAL-105-S120** Select Single, 120VAC
- BAL-115-230** Select Single, 230VAC

True Match® Lamps



- 488-K29-S** 4ft Kino KF29
- 488-K32-S** 4ft Kino KF32
- 488-K55-S** 4ft Kino KF55

- 242-K29-S** 2ft Kino KF29
- 242-K32-S** 2ft Kino KF32
- 242-K55-S** 2ft Kino KF55

Accessories and Parts



DFS-4804	4ft 4Bank Flozier, Full
DFS-4804-H	4ft 4Bank Flozier, Half
DFS-4802	4ft Double Flozier, Full
DFS-4802-H	4ft Double Flozier, Half
DFS-D4	2ft 4Bank Flozier, Full
DFS-D4-H	2ft 4Bank Flozier, Half
DFS-D2	2ft Double Flozier, Full
DFS-D2-H	2ft Double Flozier, Half

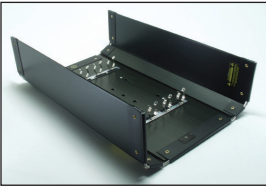

FIX-4804	4ft 4Bank Fixture Shell
FIX-4802	4ft Double Fixture Shell
FIX-4801	4ft Single Fixture Shell
FIX-2404	2ft 4Bank Fixture Shell
FIX-2402	2ft Double Fixture Shell
FIX-2401	2ft Single Fixture Shell



HAR-4804	4ft 4Bank Harness
HAR-4802	4ft Double Harness
HAR-4801	4ft Single Harness
HAR-2404	2ft 4Bank Harness
HAR-2402	2ft Double Harness
HAR-2401	2ft Single Harness

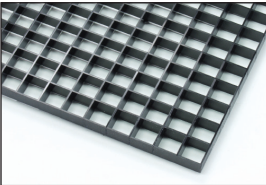

LVR-4804-B	4ft 4Bank Louver, Black
LVR-4802-B	4ft Double Louver, Black
LVR-4801-B	4ft Single Louver, Black
LVR-2404-B	2ft 4Bank Louver, Black
LVR-2402-B	2ft Double Louver, Black
LVR-2401-B	2ft Single Louver, Black

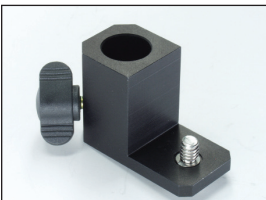

MTP-BAL	Kino Ballast Baby Mount (16mm)
----------------	--------------------------------



MTP-BL41 Kino 41L Mount w/ Baby Receiver (16mm)

MTP-BL41S Kino 41L Mount w/ Baby Rcvr Short (16mm)



MTP-L Kino 41 Lollipop w/ 3/8" Pin (10mm)

MTP-LB Kino 41 Lollipop w/ Baby Rcvr (16mm)

MTP-LBS Kino 41 Lollipop w/ Baby Rcvr Short (16mm)

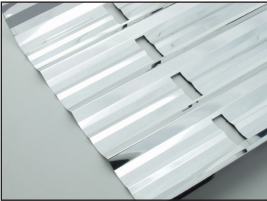

REF-4804 4ft 4Bank Reflector

REF-4802 4ft Double Reflector

REF-4801 4ft Single Reflector

REF-2404 2ft 4Bank Reflector

REF-2402 2ft Double Reflector

REF-2401 2ft Single Reflector



X16-12 4Bank Extension Cable, 12ft

X09-12 Double Extension Cable, 12ft

X04-12 Single Extension Cable, 12ft



X16-A4 4Bank to Single Splitter

X16-A9 4Bank to Double Splitter

X09-A4 Double to Single Splitter

X09-A16 Double to 4Bank Combiner

X04-A16 Single to 4Bank Combiner

X04-A9 Single to Double Combiner

Expendables

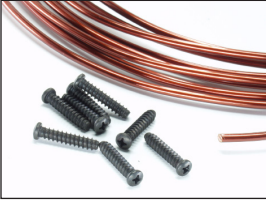

EXP-FXR-S Fixture Wire Repair Kit (Silver)



EXP-LHC-T12 Lamp Holder Clips, T12 (24pk)



EXP-M&T Adhesive Mounts & Releasable Ties (25pk)



PRT-CR4 4Bank Connector Locking Ring (4pk)
PRT-CR2 Double Connector Locking Ring (4pk)
PRT-CR1 Single Connector Locking Ring (4pk)



PRT-HLC Kino Locking Lamp Connector (1pk)

See our website at www.kinoflo.com for more repair parts.

Cases



KAS-C46

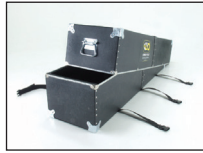

KAS-54L



KAS-KFC



BAG-201

Part Number	Description	Dimensions	Weight (Empty)	Holds
BAG-201	2ft 4Bank Soft Case	28 x 7.5 x 20" (72.5 x 19 x 51cm)	3.5 lb (2kg)	2ft 4Bank System (1), Lamp Case
BAG-401	4ft 4Bank Soft Case	55 x 8 x 19.5" (140 x 20.5 x 49.5cm)	6 lb (3kg)	4ft 4Bank System (1), Lamp Case
INS-L4	4-Lamp Foam Pad	24 x 9 x 1" (61 x 23 x 2.5cm)	N/A	Fits KAS-48, 72, 96
INS-L6	6-Lamp Foam Pad	24 x 13 x 1" (61 x 33 x 2.5cm)	N/A	Fits KAS-54S, 54L, 96L
KAS-21	2ft System Ship Case	30 x 10 x 16" (76 x 25.5 x 41cm)	12.5 lb (6kg)	2ft 4Bank System (1)
KAS-41	4ft System Ship Case	57 x 10 x 20" (145 x 25.5 x 51cm)	24.5 lb (11kg)	4ft 4Bank System (1)
KAS-48	4ft Lamp Ship Case	52.5 x 11 x 12" (133.5 x 28 x 30.5cm)	16 lb (7.5kg)	4ft Lamps (20)
KAS-54L	4ft Fixture Ship Case, Large	57.5 x 15 x 17" (146 x 38 x 43cm)	25.5 lb (12kg)	4ft 4Bank Fixtures (5)
KAS-54S	4ft Fixture Ship Case, Small	57.5 x 15 x 12" (146 x 38 x 30.5cm)	21 lb (9.5kg)	4ft 4Bank Fixtures (3)
KAS-C26	6-Lamp Carry Case (2ft)	26.5 x 6 x 4" (67.5 x 15 x 10cm)	1 lb (.5kg)	2ft Lamps (6)
KAS-C46	6-Lamp Carry Case (4ft)	50.5 x 6 x 4" (128.5 x 15 x 10cm)	1.5 lb (.7kg)	4ft Lamps (6)
KAS-GAF2	Gaffer Kit Ship Case	56.5 x 13 x 21.5" (143.5 x 33 x 55cm)	32 lb (14.5kg)	4ft 4Bank System (2), Lamp Case (2)
KAS-INT2	Interview Kit Ship Case (2)	35.5 x 13 x 22" (90 x 33 x 56cm)	25 lb (11.5kg)	2ft 4Bank System (2), Lamp Case (2)
KAS-INT3	Interview Kit Ship Case (3)	35.5 x 13 x 23" (90 x 33 x 58.5cm)	26 lb (12kg)	2ft 4Bank System, 2ft Double System (2), Lamp Case (2)
KAS-KFC	Ballast & Cable Crate w/ Lid	21.5 x 15 x 12" (54.5 x 38 x 30.5cm)	6 lb (3kg)	Ballasts, Cables, Mounting Plates

Lamp w/ Harness Specifications

Kino Flo Lamp w/ Harness Dimensions

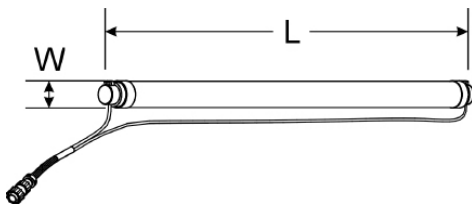

Lamp Type	Length	Width
4ft Med. Bi-Pin	48.5"	1.5"
2ft Med. Bi-Pin	24.5"	1.5"

Fixture Specifications

Kino Flo 4Bank Fixture Dimensions

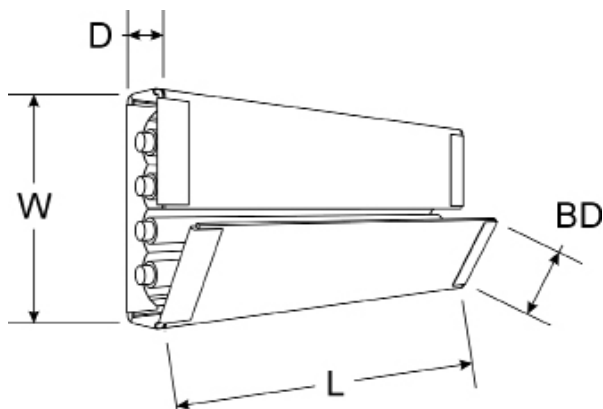

Fixture Style	Length	Width	Depth	Barndoor Width	Weight w/ Lamps
4ft 4Bank	52"	13"	3.5"	6.5"	11.5 lbs
2ft 4Bank	27"	13"	3.5"	6.5"	7.5 lbs

Kino Flo Double Fixture Dimensions

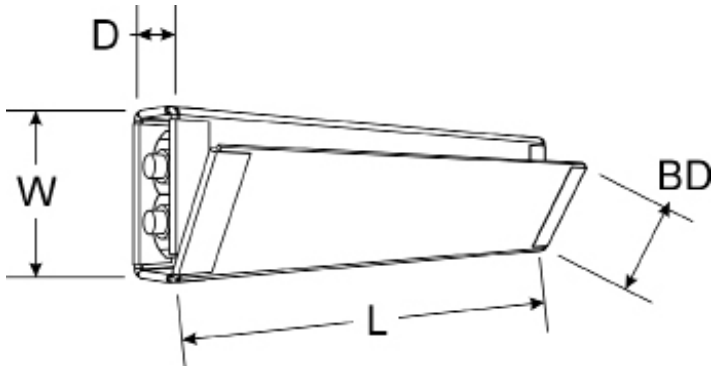

Fixture Style	Length	Width	Depth	Barndoor Width	Weight w/ Lamps
4ft Double	52"	7.5"	3.5"	6"	7.7 lbs
2ft Double	27"	7.5"	3.5"	6"	4.7 lbs

Kino Flo Single Fixture Dimensions

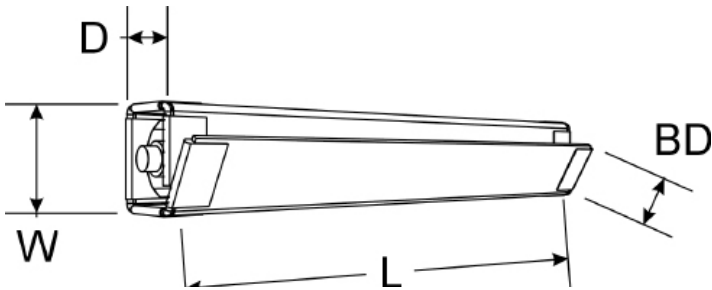

Fixture Style	Length	Width	Depth	Barndoor Width	Weight w/ Lamps
4ft Single	52"	4.5"	3.5"	3.5"	4.3 lbs
2ft Single	27"	4.5"	3.5"	3.5"	2.6 lbs

Ballast Specifications



4Bank

BAL-415-120 Select 4Bank Ballast, 120VAC

Input Voltage: 120VAC 50/60Hz
Output Frequency: 25kHz
Amperage: F75/5.0A, F40/3.5A
Lamp Switching: 1~4
Output Switching: 4ft / 2ft
Ballast Size: 13 x 9.5 x 3"
(33 x 24 x 7.6cm)
Weight: 5.5lb (2.5kg)

BAL-415-230 Select 4Bank Ballast, 230VAC

Input Voltage: 230VAC 50/60Hz
Output Frequency: 25kHz
Amperage: F75/2.5A, F40/1.8A
Lamp Switching: 1~4
Output Switching: 4ft / 2ft
Ballast Size: 13 x 9.5 x 3"
(33 x 24 x 7.6cm)
Weight: 5.9lb (2.7kg)



Double

BAL-215-120 Select Double Ballast, 120VAC

Input Voltage: 120VAC 50/60Hz
Output Frequency: 25kHz
Amperage: F75/2.6A, F40/1.8A
Lamp Switching: 1~2
Output Switching: 4ft / 2ft
Ballast Size: 9 x 9.5 x 3"
(23 x 24 x 7.6cm)
Weight: 3.5lb (1.5kg)

BAL-215-230 Select Double Ballast, 230VAC

Input Voltage: 230VAC 50/60Hz
Output Frequency: 25kHz
Amperage: F75/1.3A, F40/0.9A
Lamp Switching: 1~2
Output Switching: 4ft / 2ft
Ballast Size: 9 x 9.5 x 3"
(23 x 24 x 7.6cm)
Weight: 3.8lb (1.7kg)



Single

BAL-105-S120 Select Single Ballast, 120VAC

Input Voltage: 120VAC 50/60Hz
Output Frequency: 25kHz
Amperage: F75/1.3A, F40/0.9A, F30/0.7A
Lamp Switching: 1/off
Output Switching: 4ft / 2ft
Ballast Size: 11 x 2.5 x 2.5"
(28 x 6.5 x 6.5cm)
Weight: 2lb (0.9kg)

BAL-115-230 Select Single Ballast, 230VAC

Input Voltage: 230VAC 50/60Hz
Output Frequency: 25kHz
Amperage: F75/0.7A, F40/0.5A, F30/0.4A
Lamp Switching: 1/off
Output Switching: 4ft / 2ft
Ballast Size: 10.5 x 4 x 3"
(26.5 x 10 x 7.6cm)
Weight: 2.6lb (1.2kg)

For latest Warranty information and Certifications,
see Kino Flo website at www.kinoflo.com.

Environmental: Disposal of Old Electrical & Electronic Equipment.



This symbol on the product or on its packaging indicates that this product shall not be treated as household waste. This product is made of recyclable materials and should be disposed of in accordance with local and state regulations.

Kino Flo, Inc. 2840 N. Hollywood Way, Burbank, CA 91505, USA
Tel: 818 767-6528 website: www.kinoflo.com