

I
N
S
T
R
U
M
E
N
T
A
T
I
O
N

CONTROL SWITCHES



csii



VOLTMETER/AMMETER SWITCHES

Control Switches International, Inc.

VOLTMETER SWITCHES

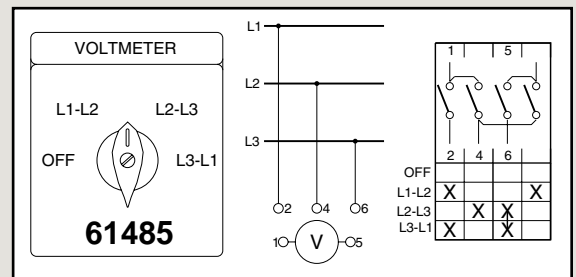
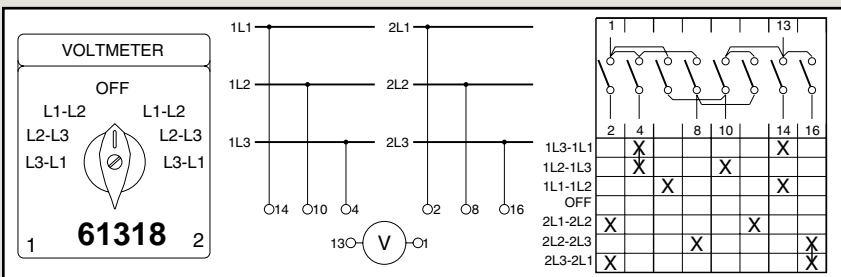
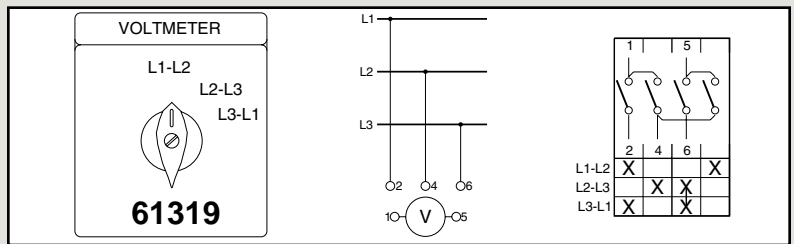
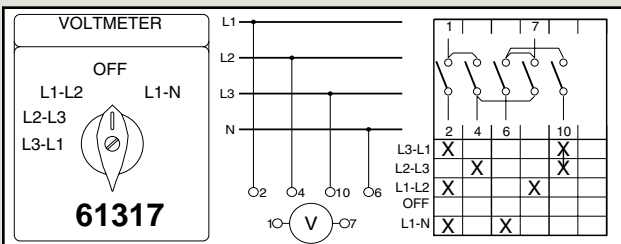
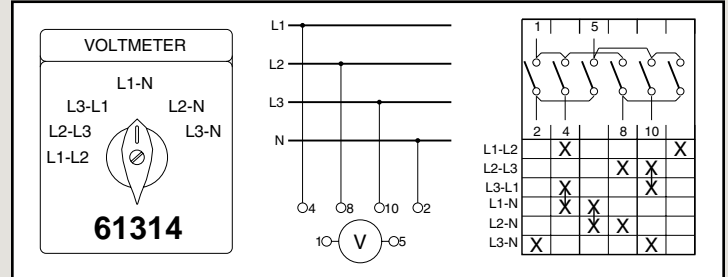
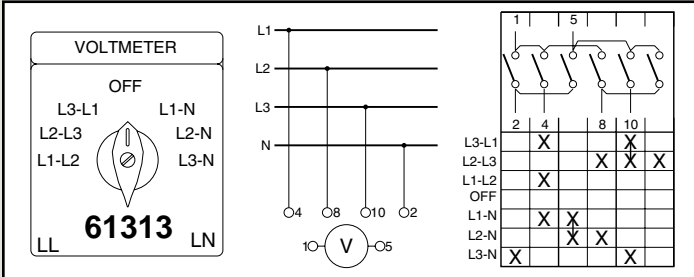
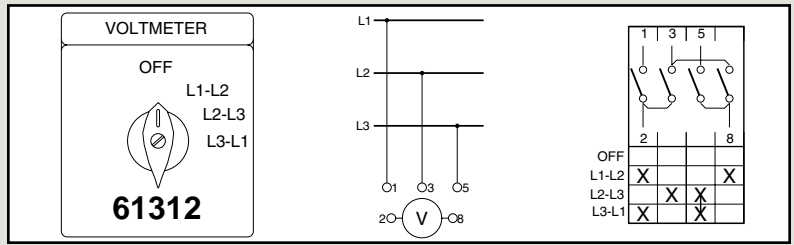
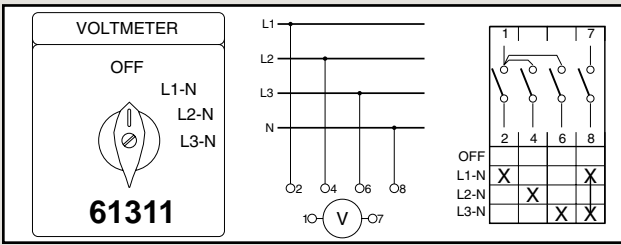

VOLTMETER/AMMETER COMBINATION SWITCHES

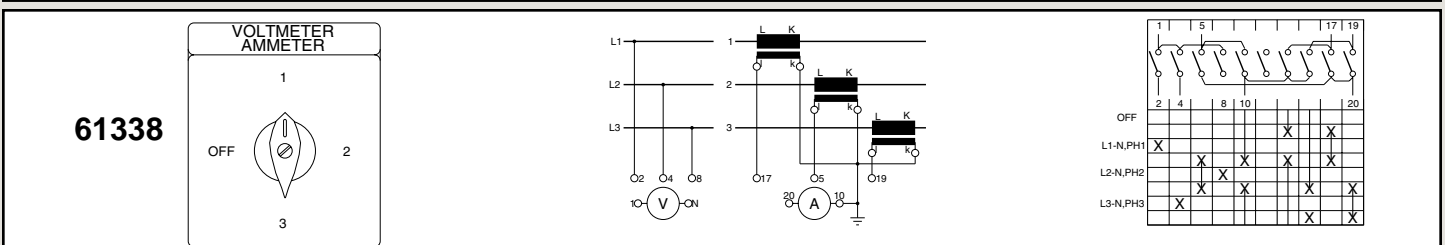
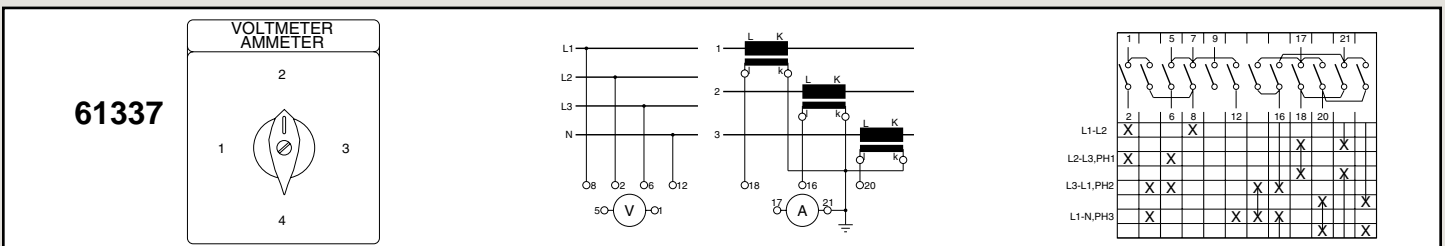
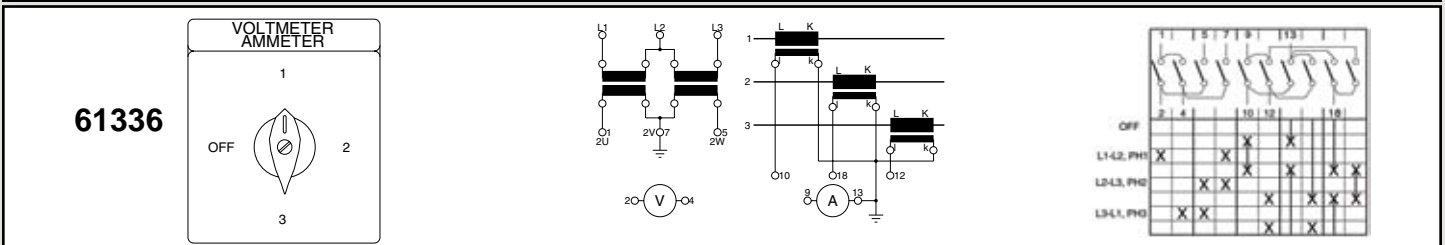

AMMETER SWITCHES

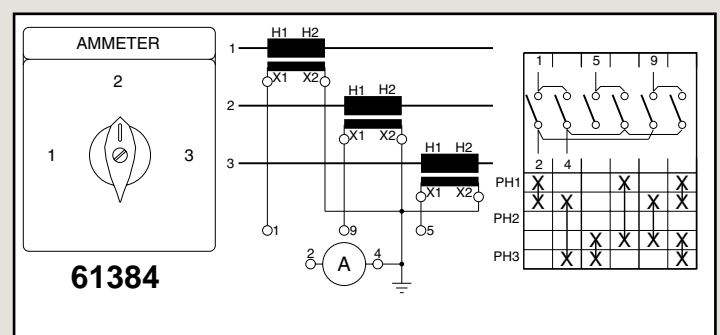
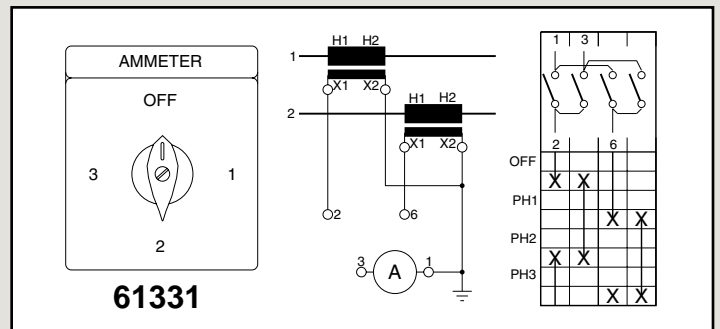
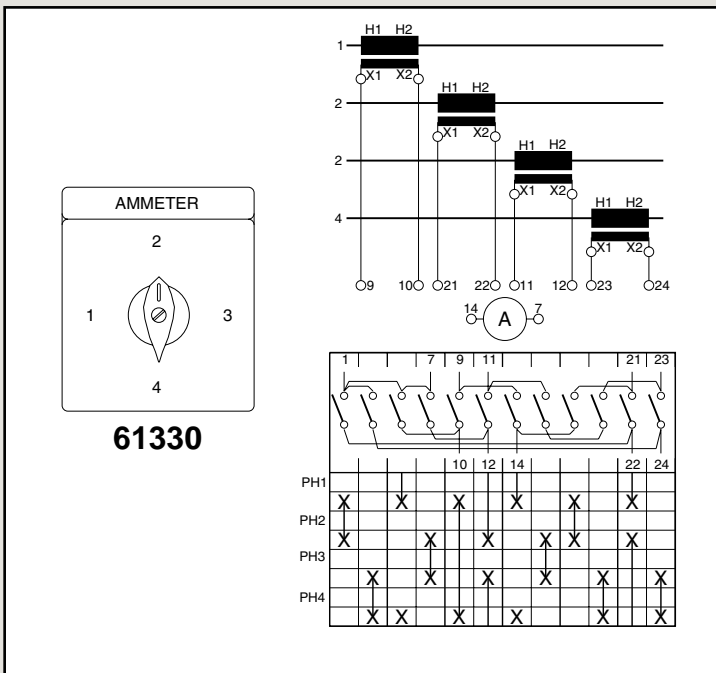
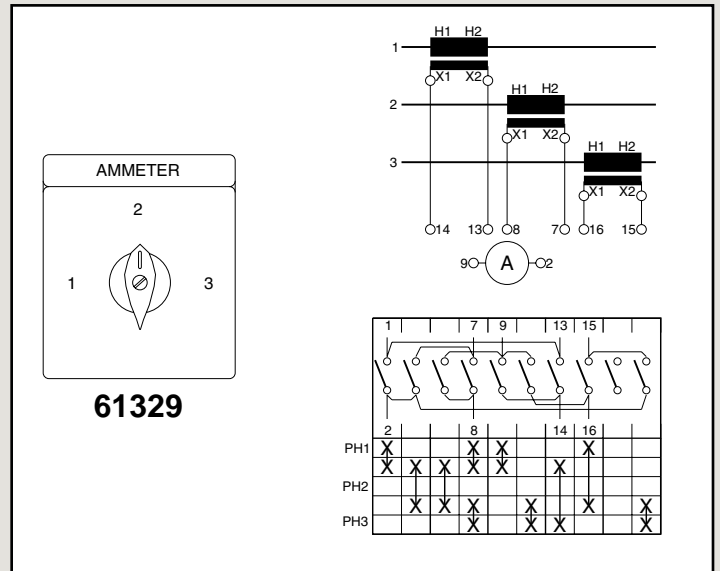
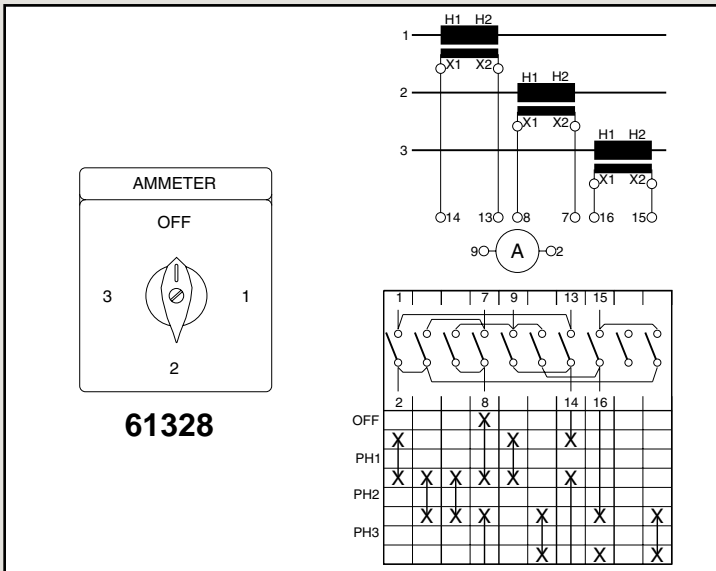
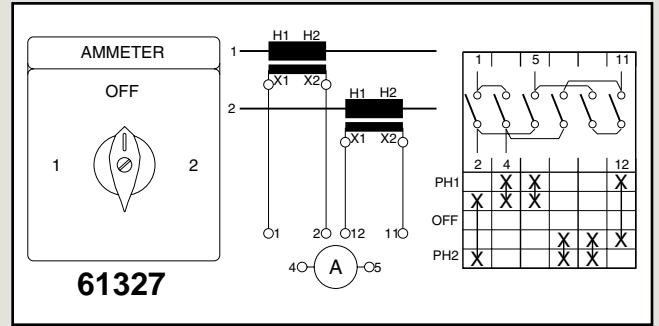
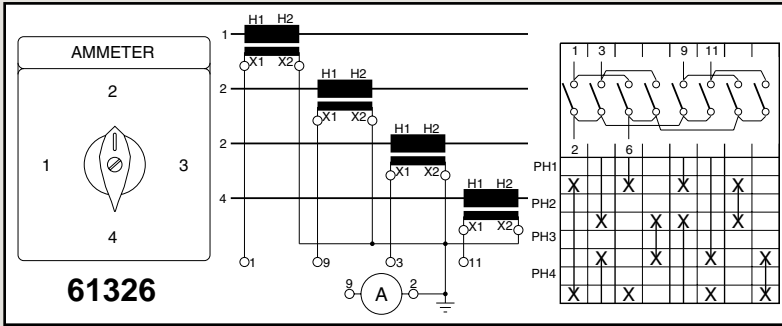
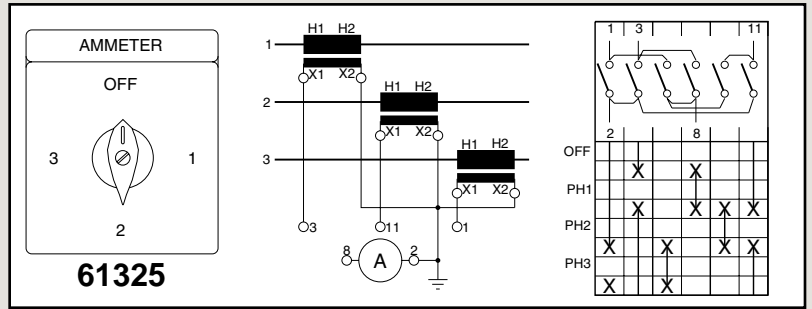
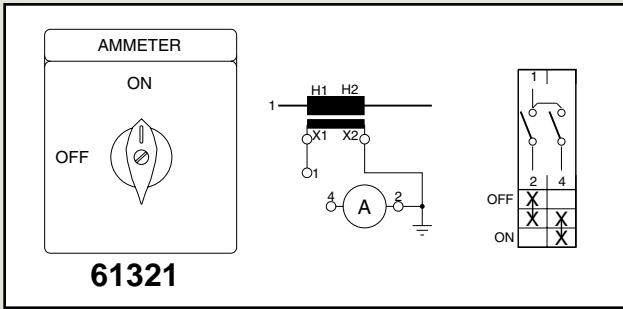

Technical Information

Switch Type	F10	F20	N12	N20	N25
UL Amperage	10	15	15	20	30
UL Voltage	240	240	300	600	600
AWG	16	16	14	12	10

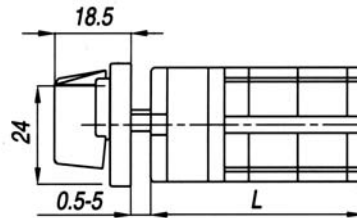
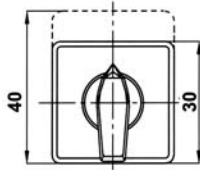
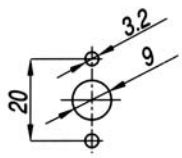

“F10” Series

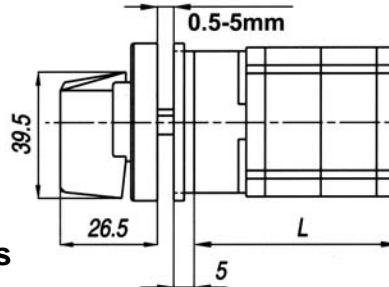
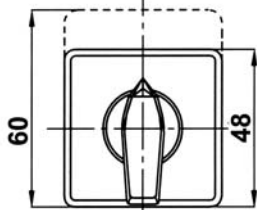
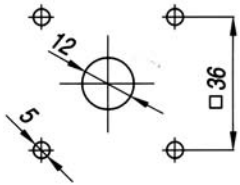

“F20” Series

Switch Type	Dimension “L” for Number of Stages (mm)											
	1	2	3	4	5	6	7	8	9	10	11	12
F10	40.0	52.0	64.0	76.0	88.0	100.0	112.0	124.0	-	-	-	-
F20	36.0	49.5	63.0	76.5	90.0	103.5	117.0	130.5	144.0	157.5	171.0	184.5

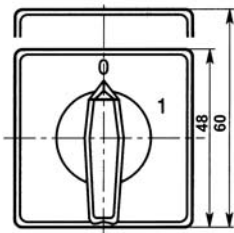

“N” Series

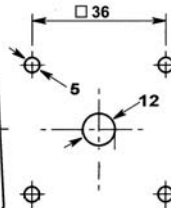
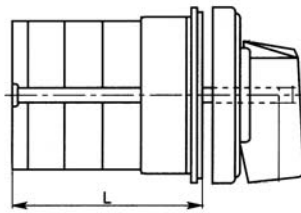

Switch Type	Dimension “L” for Number of Stages (mm)											
	1	2	3	4	5	6	7	8	9	10	11	12
N12	32.5	42.1	51.7	61.3	70.9	80.5	90.1	98.7	103.3	118.9	128.5	138.1
N20	33.1	42.8	52.5	62.2	71.9	81.6	91.3	101.0	110.7	120.4	130.1	139.8
N25	37.5	51.1	64.7	78.3	91.9	105.5	119.1	132.7	146.3	159.9	173.5	187.1

Note: Single hole mounting available on the N series.
 Next larger size mounting available on F & N Series.
 Consult factory for dimensions.

Voltmeter
Switches
-
Ammeter
Switches
-
Combination
Voltmeter
&
Ammeter
Switches
-
Single
&
Three
Phase

CONTROL SWITCHES INTERNATIONAL, INC.

2425 Mira Mar Avenue, Long Beach, CA 90815-1757

PHONE: (562) 498-7331 • (800) 521-1677 • FAX: (562) 498-5894

www.controlswitches.com • Email: sales_info@controlswitches.com

