

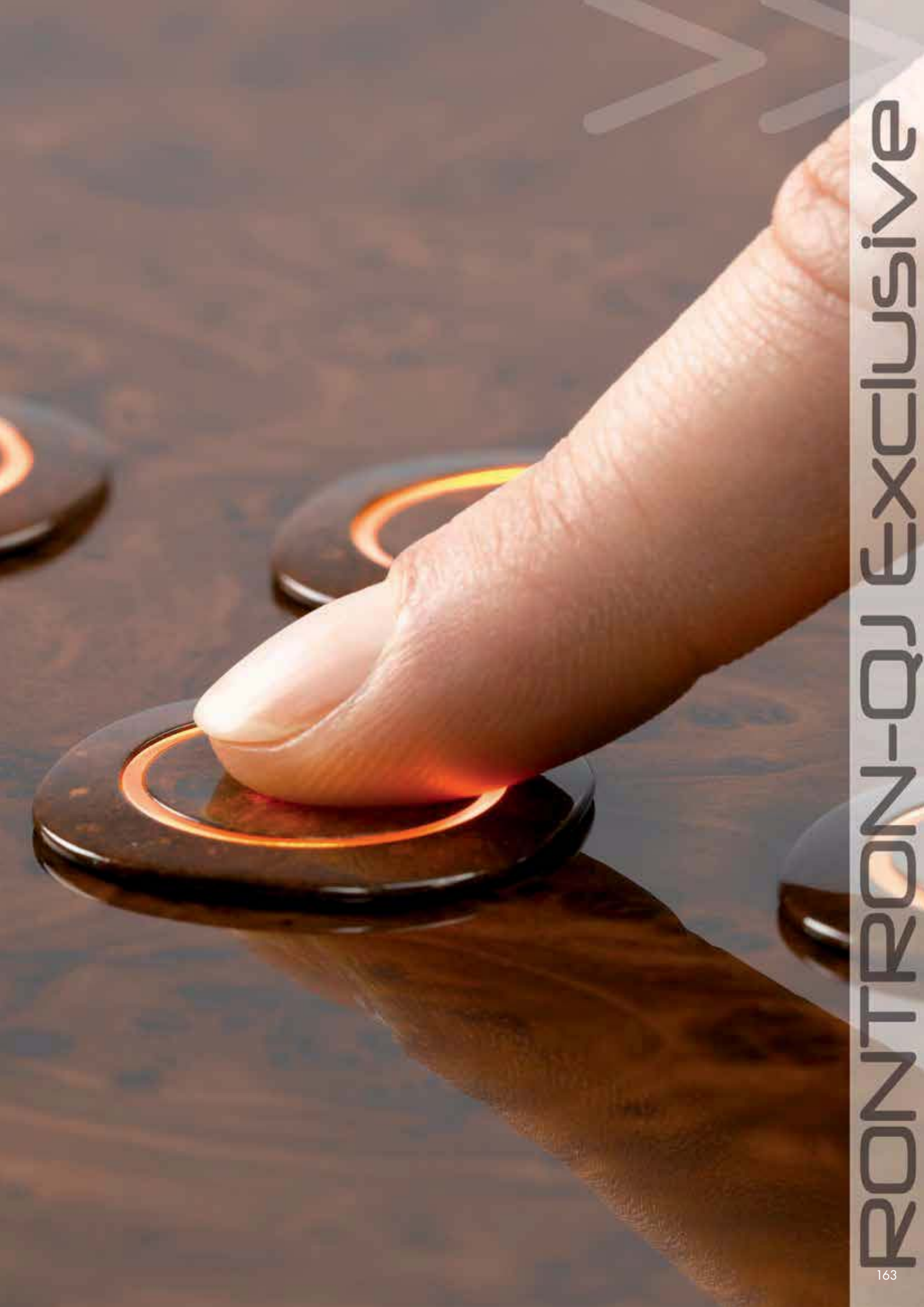

Front dimensions: 28 x 28 mm
Panel cut-out: Ø 22.3 mm
Front bezel height: 2 mm
Travel: 3 mm



RONTRON-QJ EXCLUSIVE

Mounting Depth Dimensions

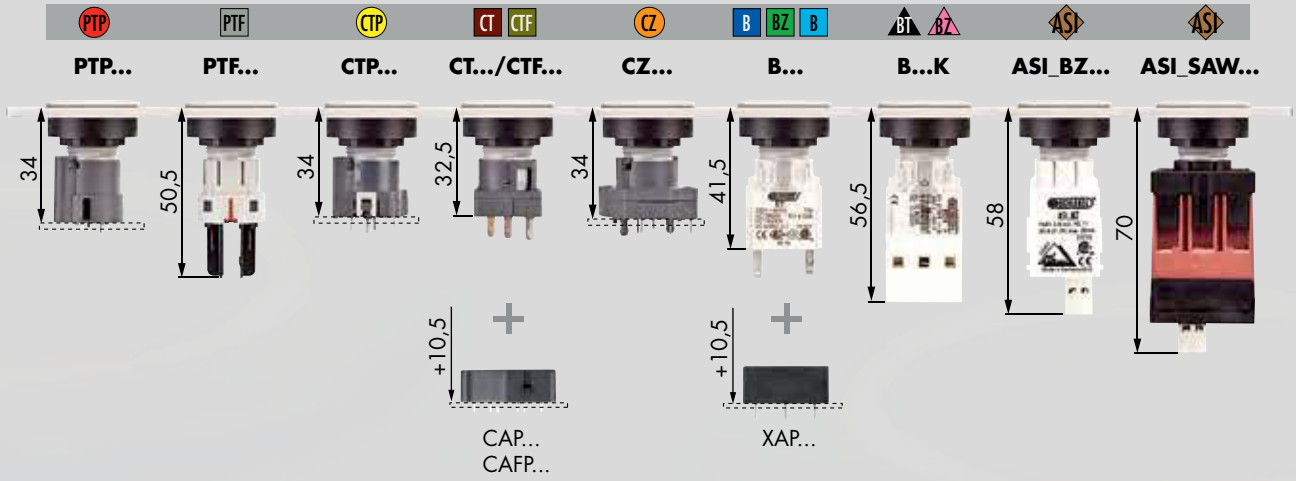



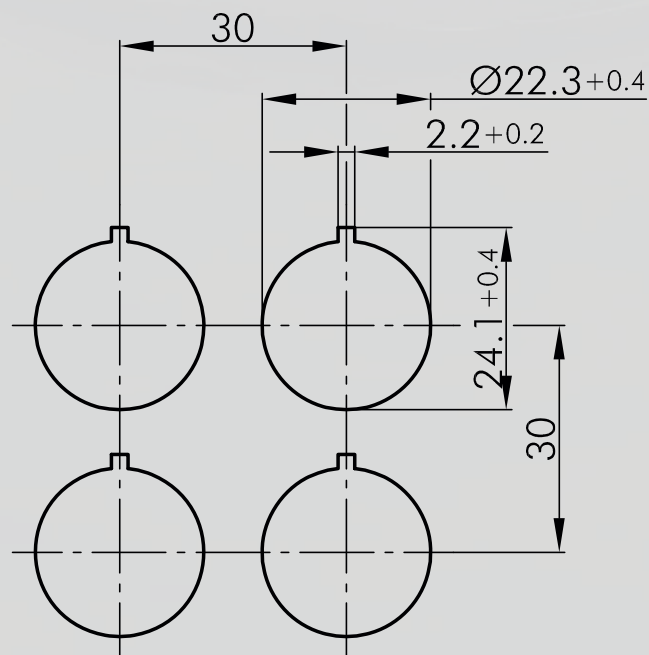



Cutout Dimensions

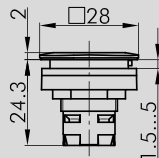

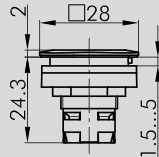
Pushbutton Heads (momentary/push-push)

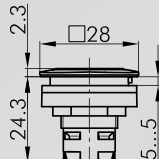
other decors on request,
for the contact combinations, refer to RQJTLR in the Rontron-Q-Juwel combination table

Illustration	Dimensions	Description	Type
 <p>IP65 3mm Light</p>		<p>Pushbutton Head with ring illumination and burl wood decor incl. push-cap</p> <p>suitable contact blocks </p> <p>front bezel burl wood decor</p>	RQJTLRE01
 <p>IP65 3mm Light</p>		<p>Pushbutton Head with ring illumination and carbon decor incl. push-cap</p> <p>suitable contact blocks </p> <p>front bezel carbon decor</p>	RQJTLRE02
 <p>IP65 3mm Light</p>		<p>Pushbutton Head with ring illumination, white coated incl. lens</p> <p>suitable contact blocks </p> <p>front bezel white</p>	RQJTLRWS