

AMS 5915

Amplified pressure sensor with digital output (I²C)



Analog - Digitale
Mikromechanische
Sensorsysteme

GENERAL DESCRIPTION

AMS 5915 pressure sensors are a series of high-precision OEM sensors with a digital I²C-interface. They combine a micromachined, high quality piezoresistive measuring cell with a modern, digital signal conditioning mixed-signal CMOS-ASIC on a ceramic substrate. AMS 5915 is calibrated and compensated for across a wide temperature range of -25 to +85°C.

AMS5915 comes as a dual in-line package (DIP) for assembly on printed circuit boards (PCBs) and is fully operational without the need for any additional components. The electrical connection is made via the DIP solder pins; pressure is connected via two vertical metal tubes.

The sensors in the AMS 5915 series are available for various applications and pressure ranges: differential (relative) devices in pressure ranges from 0 – 5 mbar up to 0 – 1 bar, an absolute pressure variant for 0 – 1 bar and a barometric type. Bidirectional differential devices are available in pressure ranges from -5 – +5 mbar up to -1 – +1bar. Customer specific pressure ranges or modifications are available on request.

FEATURES

- **Calibrated and temperature compensated pressure sensor with digital output (I²C)**
- **Differential/relative, bidirectional and absolute (barometric) versions**
- **Digital output for pressure and temperature via I²C interface**
- **High accuracy at RT**
- **Small overall error within a temperature range of -25 ... 85°C**
- **Supply voltage range 3.0...3.6V**
- **Excellent long term stability**
- **Small DIP package**
- **Ready to use**
- **RoHS compliant**

TYPICAL APPLICATIONS

- Static and dynamic pressure measurement
- Barometric pressure measurement
- Vacuum monitoring
- Gas flow
- Fluid level measurement
- Medical instrumentation
- Heating, Ventilation and Air Conditioning (HVAC)

AMSYS GmbH & Co. KG

An der Fahrt 13
55124 Mainz

Tel.: +49 (0)6131-469875 - 0
Fax: +49 (0)6131-469875 - 66
Internet: www.amsys.de
E-Mail: info@amsys.de

Sold in North America by:

Servoflo Corporation
75 Allen Street Lexington, MA 02421
Tel: 781-862-9572

www.servoflo.com / info@servoflo.com



AMS 5915 Amplified pressure sensor with digital output (I²C)

PRESSURE RANGES

Sensor type (code)	Pressure type	Pressure range in mbar	Burst pressure in bar	Pressure range in PSI	Burst pressure in PSI
Ultra low pressure					
AMS 5915-0005-D	differential / relative	0 ... 5	>0.5	0 ... 0.0725	>7.5
AMS 5915-0010-D	differential / relative	0 ... 10	>0.5	0 ... 0.145	>7.5
AMS 5915-0005-D-B	bidirectional differential	-5 / +5	>0.5	-0.0725 / +0.0725	>7.5
AMS 5915-0010-D-B	bidirectional differential	-10 / +10	>0.5	-0.145 / +0.145	>7.5
Low pressure					
AMS 5915-0020-D	differential / relative	0 ... 20	>0.5	0 ... 0.290	>7.5
AMS 5915-0050-D	differential / relative	0 ... 50	>1	0 ... 0.725	>15
AMS 5915-0100-D	differential / relative	0 ... 100	>1	0 ... 1.450	>15
AMS 5915-0020-D-B	bidirectional differential	-20 / +20	>0.5	-0.290 / +0.290	>7.5
AMS 5915-0050-D-B	bidirectional differential	-50 / +50	>1	-0.725 / +0.725	>15
AMS 5915-0100-D-B	bidirectional differential	-100 / +100	>1	-1.450 / +1.450	>15
Standard pressure					
AMS 5915-0200-D	differential / relative	0 ... 200	5	0 ... 2.901	72
AMS 5915-0350-D	differential / relative	0 ... 350	5	0 ... 5.076	72
AMS 5915-1000-D	differential / relative	0 ... 1000	5	0 ... 14.50	72
AMS 5915-0200-D-B	bidirectional differential	-200 / +200	5	-2.901 / +2.901	72
AMS 5915-0350-D-B	bidirectional differential	-350 / +350	5	-5.076 / +5.076	72
AMS 5915-1000-D-B	bidirectional differential	-1000 / +1000	5	-14.50 / +14.50	72
AMS 5915-1000-A	absolute	0 ... 1000	5	0 ... 14.5	72
AMS 5915-1200-B	barometric	750 ... 1200	5	10.88 ... 17.4	72

Table 1: AMS 5915 standard pressure ranges (other ranges on request)

BOUNDARY CONDITIONS

Parameter	Minimum	Typical	Maximum	Units
Maximum supply voltage: V_S (max)			6.0	V
Operating temperature: T_{op}	-25		85	°C
Storage temperature: T_{amb}	-40		125	°C

Table 2: Boundary Conditions

AMS 5915 Amplified pressure sensor with digital output (I²C)

SPECIFICATIONS

All parameters apply to $V_S = 3.3V$ and $T_{op} = 25^{\circ}C$, unless otherwise stated.

Parameter	Minimum	Typical	Maximum	Units
Digital output signal (pressure) ²⁾				
@ specified minimum pressure (see "pressure range") ¹⁾		1638		counts
@ specified maximum pressure (see "pressure range") ¹⁾		14745		counts
Full span output (FSO) ³⁾		13107		counts
without pressure (bidirectional differential)		8192		counts
Digital output signal (temperature) ⁴⁾				
@ minimum temperature T = -25°C		256		counts
@ maximum temperature T = 85°C		1382		counts
Accuracy ⁵⁾ (pressure measurement) @ T = 25°C				
Ultra low pressure sensors (5, 10 mbar)			±1.5	%FSO
Low pressure sensors (20, 50, 100 mbar)			±1.0	%FSO
Standard pressure sensors			±0.5	%FSO
Total accuracy ⁶⁾ (pressure meas.) @ T = -25...85°C				
Ultra low pressure sensors (5, 10 mbar)			±2.0	%FSO
Low pressure sensors (20, 50, 100 mbar)			±1.5	%FSO
Standard pressure sensors			±1.0	%FSO
Total error for temperature measurement				
All types of AMS 5915 T = -25...85°C			tdb	%FSO
Long term stability			<0.5	%FSO/a
Resolution A/D converter		14		bits
Resolution pressure signal		12		bits
Resolution temperature signal			11	bits
Supply voltage (V_S)		3.3		V
Overall ratiometricity error (@ $V_S = 3.0 \dots 3.6V$)		±0.025	±0.1	%FSO
Current consumption			5	mA
Reaction time (10%...90% rise time)		0.5	1	ms
Start up time (Power up to data ready)			10	ms
I2C-interface				
Input High Level	80		100	% V_S
Input Low Level	0		20	% V_S
Output Low Level	0		10	% V_S
Load capacitance @ SDA			200	pF
Clock frequency SCL		100	400	kHz
Pull-up resistor	500			Ω
Pressure changes	10 ⁶			
Compensated temperature range	-25		85	°C
Weight		3		g
Media compatibility	See "Specification notes" ^{7) 8)}			

Table 3: Specifications

AMS 5915 Amplified pressure sensor with digital output (I²C)

SPECIFICATION NOTES

- 1) For pressure ranges see *Table 1*
- 2) The digital output pressure signal is not ratiometric to the supply voltage.
- 3) The Full Span Output (FSO) is the algebraic difference between the output signal at the specified maximum pressure and the output signal at the specified minimum pressure (see "Pressure range").
- 4) The digital output temperature signal is not ratiometric to the supply voltage. The digital readout temperature value is the sensor temperature (including self heating).
- 5) Accuracy is defined as the maximum deviation of the measurement value from the ideal characteristic curve at room temperature (RT) in %FSO including the adjustment error (offset and span), nonlinearity, pressure hysteresis and repeatability. Nonlinearity is the measured deviation from the best fit straight line (BFSL) across the entire pressure range. Pressure hysteresis is the maximum deviation of the output value at any pressure within the specified range when this pressure is cycled to and from the minimum or maximum rated pressure. Repeatability is the maximum deviation of the output value at any pressure within the specified range after 10 pressure cycles.
- 6) The total accuracy is defined as the overall error, i.e. the maximum deviation of the measurement value from the ideal characteristic curve in %FSO across the entire temperature range (-25 ... 85°C).
- 7) Media compatibility of pressure port 1 (for a description of port 1, see *Figure 5*): clean, dry gases, non-corrosive to silicon, RTV silicone rubber, gold (alkaline or acidic liquids can destroy the sensor).
- 8) Media compatibility of pressure port 2 (for a description of port 2, see *Figure 5*): fluids and gases non-corrosive to silicon, Pyrex, RTV silicone rubber.

FUNCTIONAL DESCRIPTION

The pressure sensors in the AMS 5915 series combine a high quality piezoresistive silicon sensing element with a modern mixed-signal CMOS ASIC with full digital correction for signal conditioning on a ceramic substrate. This enables high precision measurements and excellent drift and long-term stability.

The functional principle of the AMS 5915 sensors is explained in *Figure 1*.

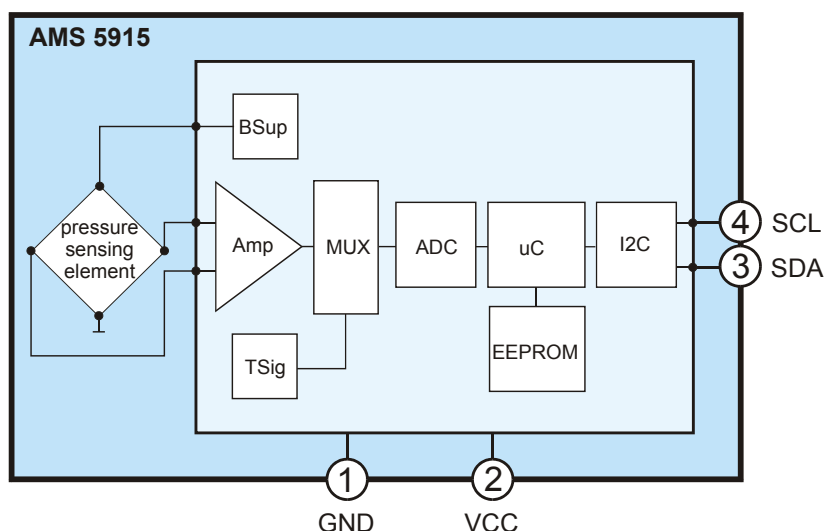

Figure 1: Functional principle

The physical pressure is measured at AMS 5915's piezoresistive pressure sensing element where the pressure is converted into a differential voltage signal which is almost proportional to the pressure. This differential voltage signal is corrected and conditioned by the ASIC in multiple steps.

AMS 5915 Amplified pressure sensor with digital output (I²C)

Firstly, the differential voltage signal from the sensing element is pre-amplified by the ASIC amplifier stage and transmitted by a multiplexer to the A/D converter (ADC). The ADC converts the signal into digital values with a resolution of 14 bits. The digitized signal is corrected and calibrated in the follow-on ASIC microcontroller.

Factory precision calibration of each AMS 5915 sets the sensor-specific correction coefficients and stores these in the EEPROM for each sensor. This permits sensor-specific calibration and correction (i.e. temperature compensation and linearization) of the digitized pressure signal. The temperature signal necessary for temperature compensation is generated at the ASIC temperature reference block and is transmitted by the multiplexer to the ADC, where it is digitized. The ASIC microcontroller runs a cyclic program which continuously calculates the current standardized and corrected digital pressure value using the actual digitized pressure and temperature values and the stored correction coefficients. In addition, a standardized current digital temperature value is calculated. These calculated and corrected digital values (14-bit pressure value and 11 bit temperature value) are written to the ASIC output registers and continuously updated (typically every 0.5 ms).

The signal readout of the corrected digital pressure and temperature values is done via the I2C sensor interface at PIN3 (SDA) and PIN4 (SCL). These digital output values (for pressure and temperature) are not ratiometric to the supply voltage.

INITIAL OPERATION

The sensors are connected up electrically by mounting them on a PCB, pins 1 – 4 have to be connected as shown in *Figure 2*.

Important: Each I2C-bus communication line has to be connected up to the positive supply voltage VCC (or +3.3V) using pull-up resistors (4.7 k is recommended).

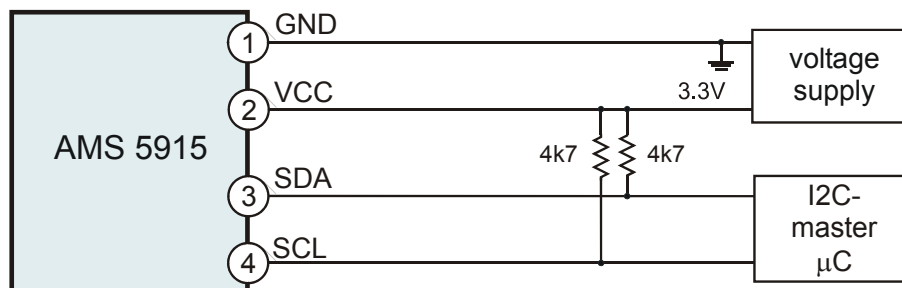

Figure 2: Principle electric circuitry

The pressure connection is made using the two metal pressure ports (hose connectors) on the sensor. Depending on the type of sensor and measuring pressure one or two of the pressure ports are connected up to the measuring media / volume. For the pressures at port 1 and 2 (see *Figure 5*) the following requirements have to be fulfilled (according to the definition p_1 = pressure at port 1 and p_2 = pressure at port 2):

Differential / relative pressure sensors:	$p_1 > p_2$
Bidirectional differential sensors:	$p_1 > p_2$ or $p_1 < p_2$ possible.
Absolute pressure sensors, barometric sensors:	p_1 = measuring pressure.

The guidelines on media compatibility must be taken into account here (see "Specification notes", 7 and 8).

Note: ESD precautions are necessary, it is essential to ground machines and personnel properly during assembly and handling of the device

AMS 5915 Amplified pressure sensor with digital output (I²C)

I2C-INTERFACE

AMS 5915 pressure sensors have a digital output (I2C-interface). When connected to a bidirectional I2C-bus, the current corrected digital pressure and temperature values can be read out from the output register of the AMS 5915 via the I2C-interface.

Communication via the I2C-bus follows a simple master-slave principle. Data transfer is always initialized by a master (such as a microcontroller, for example), which sends a data request to the sensor; the AMS 5915 sensor – which always operates as slave – then answers.

The I2C-bus requires just two bus lines: a serial data line (SDA) and a serial clock line (SDL). SDA and SDL are bidirectional lines which are connected to the positive supply voltage via pull-up resistors.

AMS 5915 communication protocol adheres to a standard I2C communication protocol (given in *Figure 3*)¹.

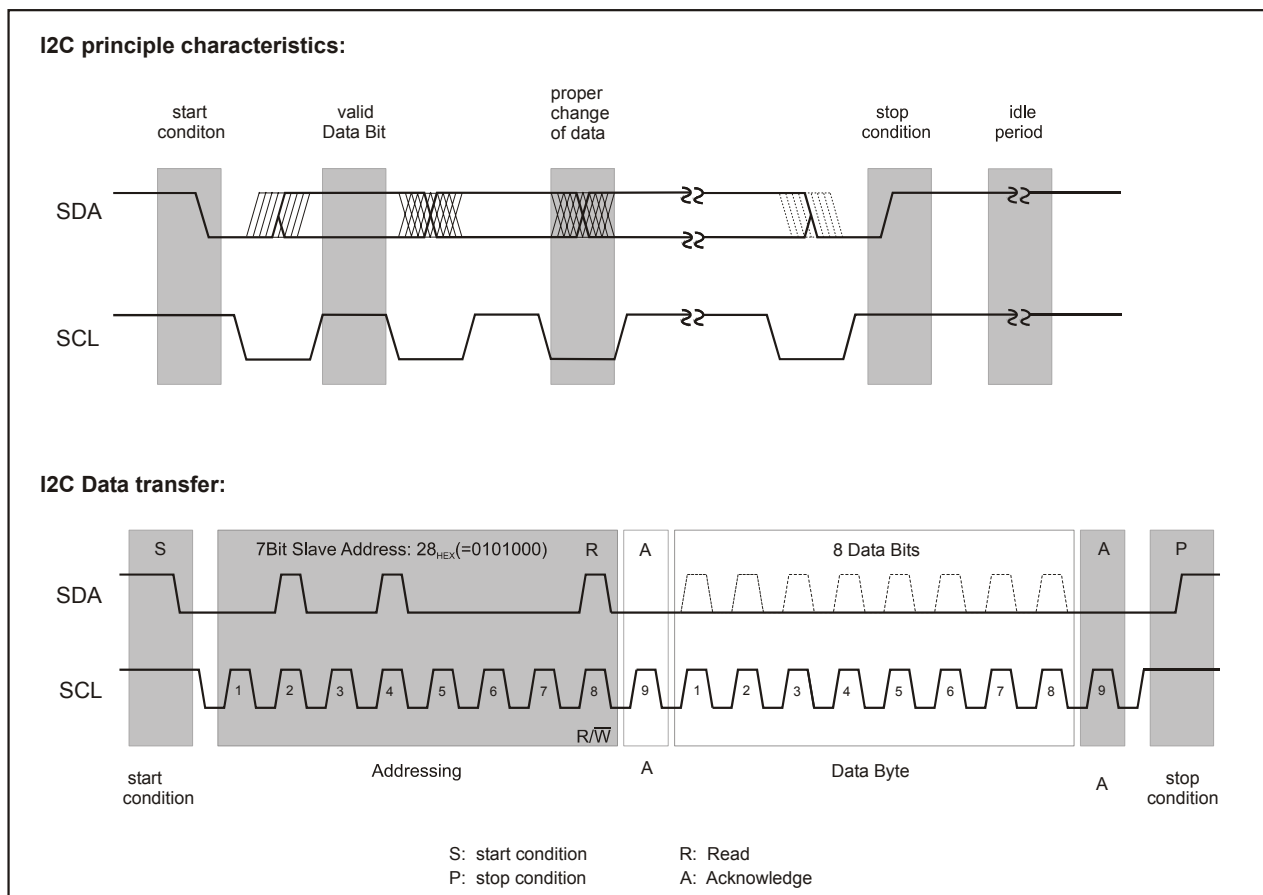

Figure 3: Standard I2C protocol

¹ There are three differences of AMS 5915 communication protocol compared to the original I2C communication protocol:

1. A direct sending of a stop condition after a start condition without no clock pulses in between is not allowed. This creates a communication error for the next communication.
2. A second start condition (restart) during data transmission when SCL is still high is not allowed.
3. Between the start condition and the first rising SCL edge a falling SDA edge is not allowed.

AMS 5915 Amplified pressure sensor with digital output (I²C)

The I2C communication phases are as follows:

Idle period (bus is free)

When the bus is free, both I2C-bus lines (SDA and SCL) are pulled up to supply voltage level ("high").

Start S (start condition)

Prior to any data transfer on the bus a start condition must be generated. The start condition is always sent by the I2C-master. The start condition is defined as a transition from level "high" to "low" on the SDA line while the level on the SCL line is "high". The digital data readout from the AMS 5915 is always initiated by a start condition.

Stop P (stop condition)

The stop condition is always generated by the I2C-master after a data transfer has been completed. The stop condition is defined as a transition from level "low" to "high" on the SDA line while the level on SCL line is "high". The digital data readout from the AMS 5915 is always terminated by a stop condition.

Valid data

Data is transmitted in bytes (8 bits), starting with the most significant bit (MSB). One data bit is transmitted with each clock pulse. The transmitted bits are only valid when, following a start condition, the level on the SDA line is constant for as long as the level on SCL line is "high". Changes to the SDA level must be made while the level on SCL line is "low".

Acknowledge A

After a byte has been transmitted the respective receiver (master or slave) has to send an acknowledge (additional acknowledge bit) confirming the correct receipt of the data. To this end the master generates an extra acknowledge-related clock pulse. The receiver sends the acknowledge bit by pulling the level on SDA line down to "low" during the additional clock pulse.

Addressing / Slave address (I2C-address AMS 5915)

After the start condition the master sends an addressing byte (the first byte after the start condition) which determines which slave is selected. The addressing byte contains the individual 7-bit slave address of the selected slave (AMS 5915) and a data direction bit (R/W). An "0" for the R/W bit indicates a transmission from master to slave (W: write; the master wishes to transmit data to the selected slave), a "1" a data request (R: read; the master requests data from the slave).

The pressure sensors in the AMS 5915 series have a standard, factory-programmed 7-bit slave address of 0x28Hex (0101000b).

AMS 5915 Amplified pressure sensor with digital output (I²C)

DATA READOUT VIA THE I2C-INTERFACE

The digital output values for pressure (14 bit value) and temperature (11 bit value) are read out from the AMS 5915 output register via the AMS 5915 I2C-interface. The data readout, which is illustrated in *Figure 4*, is done byte per byte.

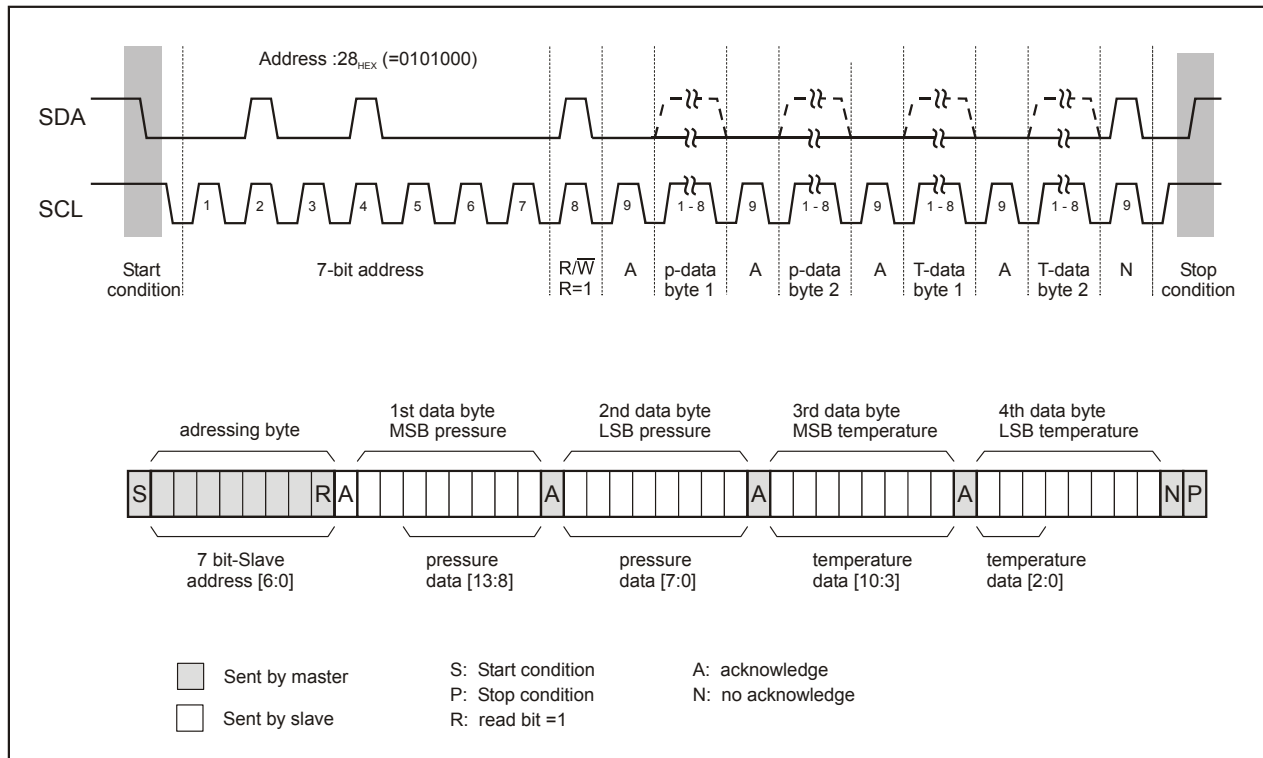

Figure 4: Data readout of the digital pressure and temperature values

Data transfer via the I2C-bus is always initialized by a data request from the I2C-master. For this purpose the I2C-master generates a start condition on the I2C-bus lines. Following the start condition the I2C-master then sends the addressing byte containing the 7-bit slave address of the AMS 5915 (programmed to 0x28Hex = 0101000b at the factory) and the data direction bit R=1 which indicates a data request. The selected pressure sensor first answers with an acknowledge bit. The selected sensor then starts the data transfer from the output register.

For pressure and temperature value readout a total of four data bytes are transmitted from the pressure sensor to the I2C-master. The two bytes for the current digital pressure value are first sent, followed by the two bytes for the current digital temperature value, always beginning with the most significant byte. On each transferred data byte the I2C-master sends an acknowledge bit confirming the correct receipt of data. After the 4th data byte, the receiving master generates a no acknowledge bit; the pressure sensor is set to inactive. The I2C-master shuts down the data transfer by sending a stop condition.

The 14 bit pressure value is given by the last 6 bits of the 1st data byte and the 8 bits of the 2nd data byte always beginning with the most significant bit. The 11 bit temperature value is given by the 8 bits of the 3rd data byte and the first 3 bits of the 4th data byte.

For pressure value readout only it is possible to stop the data transfer after two data bytes. In this case the I2C-master sends a no acknowledge bit after the 2nd data byte and shuts down the data transfer by sending a stop condition.

AMS 5915 Amplified pressure sensor with digital output (I²C)

Calculating the current pressure and temperature value

The digital output values for pressure (14 bit value) and temperature (11 bit value) have to be converted in order to generate the desired information on pressure and temperature in physical units.

The current pressure in bar (or PSI) is calculated from the digital pressure value using the following formulas:

$$p = \frac{Digoutp(p) - Digoutp_{min}}{Sensp} + p_{min} \quad \text{with} \quad Sensp = \frac{Digoutp_{max} - Digoutp_{min}}{p_{max} - p_{min}} \quad (1)$$

Therein p is the current pressure in bar (or PSI), p_{min} is the specified minimum pressure and p_{max} is the specified maximum pressure in bar (or PSI); depending on the specified pressure range, $Digoutp(p)$ is the current digital 14 bit pressure value in counts, $Digoutp_{min}$ and $Digoutp_{max}$ are the digital pressure values at minimum and maximum specified pressure in counts and $Sensp$ is the sensitivity of the pressure sensor in counts/bar (or counts/PSI).

The current sensor temperature in °C is calculated from the digital temperature value using the following formula:

$$T = \frac{DigoutT(T) * 200}{2048} + 50 \quad \text{in } ^\circ\text{C} \quad (2)$$

Therein T is the current sensor temperature in °C and $DigoutT(T)$ is the current 11 bit digital temperature value in counts.

Example

At the digital output of an AMS 5915-0005-D-B (-5...5 mbar bidirectional differential) the following data bytes 1...4 are read:

Byte 1: 00101100 Byte 2: 11001101 Byte 3: 01011100 Byte 4: 11100000

Taking the last 14 bits of byte 1 and byte 2 the current 14bit digital pressure value is:

$$Digoutp(p) = 10110011001101_{bin} \text{ counts} = 2CCD_{Hex} \text{ counts} = 11469_{Dec} \text{ counts}$$

and with the first 11 bits of byte 3 and byte 4 the digital temperature value is:

$$DigoutT(T) = 01011100111_{bin} \text{ counts} = 2E7_{Hex} \text{ counts} = 743_{Dec} \text{ counts} .$$

With $p_{min} = -5$ mbar, $p_{max} = 5$ mbar and $Digoutp_{min} = 1638$, $Digoutp_{max} = 14745$ specified for AMS 5915-0005-D-B the current pressure in mbar is calculated using formula (1) as:

$$p = \frac{(11469 - 1638) \text{ counts}}{(13107 / 10) \text{ counts/mbar}} + (-5) \text{ mbar} = 2.501 \text{ mbar}$$

Using formula (2), the current sensor temperature in °C is calculated as:

$$T = \frac{(743 * 200) \text{ counts} * ^\circ\text{C}}{2048 \text{ counts}} - 50 \text{ } ^\circ\text{C} = 22.6 \text{ } ^\circ\text{C}$$

AMS 5915 Amplified pressure sensor with digital output (I²C)

DIMENSIONS AND PINOUT

AMS 5915 pressure sensors come in a dual-in-line package (DIP) for assembly on printed circuit boards (PCB).

Figure 5 below gives the pinout and dimensions of the dual-in-line package.

Pin-Out and pressure connection:

differential types:

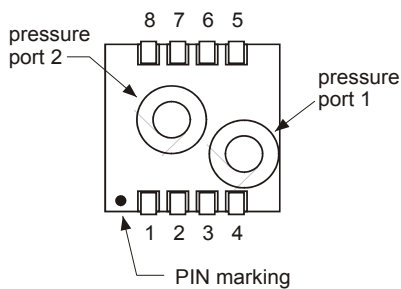

absolute, barometric types:

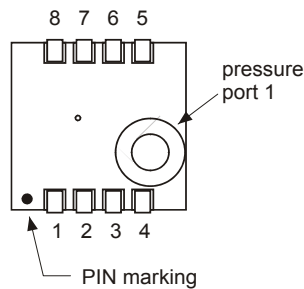

Pin	Description
1	GND.
2	VCC
3	SDA
4	SCL
5	N.C.
6	N.C.
7	N.C.
8	N.C.

Package Dimensions:

Side view :

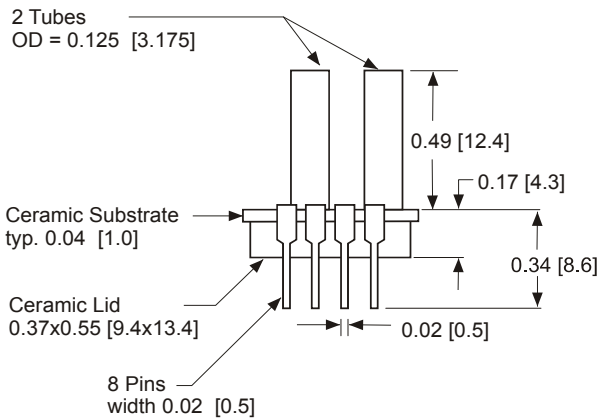

Top view :

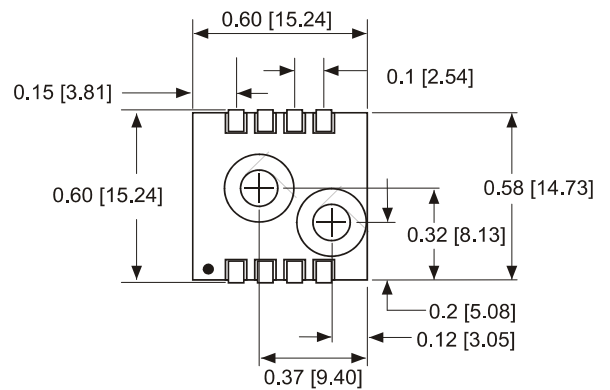

all Dimensions in inch [mm]

Figure 5: Dimensions

All sensors in the AMS 5915 series are maintenance free during their lifetime.

AMS 5915 Amplified pressure sensor with digital output (I²C)

INFORMATION FOR ORDERING

Ordering code:

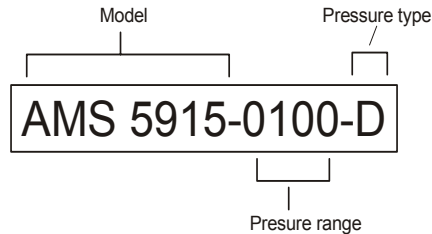

Pressure range:

Pressure range code	mbar	PSI	kPa
0005	5	0.073	0.5
0010	10	0.145	1.0
0020	20	0.290	2.0
0050	50	0.725	5.0
0100	100	1.450	10
0200	200	2.901	20
0350	350	5.076	35
1000	1000	14.50	100
1200	1200	17.40	120

Table 4: Pressure ranges

Pressure type:

Pressure type code	Available pressure ranges
D differential / relative (gage)	0...5 mbar to 0...1 bar
D-B bidirectional differential	-5/ +5 mbar to -1/ 1 bar
A absolute	0...1000 mbar
B barometric (absolute)	700 ... 1200 mbar

Table 5: Pressure types

ADDITIONAL EQUIPMENT

A starter kit with software is available for AMS 5915 sensors. The starter kit permits easy readout of the digital I2C output (pressure and temperature) by a standard PC.

Sold in North America by:
Servoflo Corporation
75 Allen Street Lexington, MA 02421
Tel: 781-862-9572
www.servoflo.com / info@servoflo.com

AMSYS reserves the right to amend any dimensions, technical data or other information contained herein without prior notification.