

nifty



SD34T

SELF DRIVE WORK PLATFORM



35ft

Platform height

20ft

Working outreach

Weight Saving Design

Easily transported & maneuvered on site

Telescopic Upper Boom

Greater accuracy when positioning the platform

Bi-Energy Available

Optimises utilization

Fully Proportional Hydraulic Controls

Simple, reliable & easy to maintain

Hydraulic Outriggers

For quick & easy set up



niftylift.com



nifty SD34T

The **SD34T** delivers an impressive working envelope and with the advantage of a telescopic upper boom, supreme accuracy when positioning the platform. Hydraulic outriggers and 45% gradeability allow it to be driven and levelled on uneven surfaces making it ideal for environments with rough or softer ground and its low overall weight means better fuel efficiency and lower transportation costs.

SAFETY FEATURES

- Pressure sensitive outriggers with
- Audible & visual alarms
- Dual controls (platform & base)
- Manual descent with hand-pump
- Lock valves on all hydraulic cylinders
- Meets OSHA and ANSI Regulations

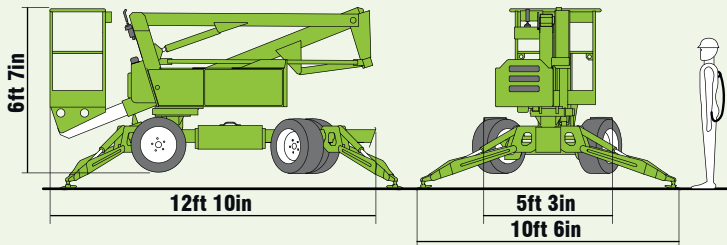
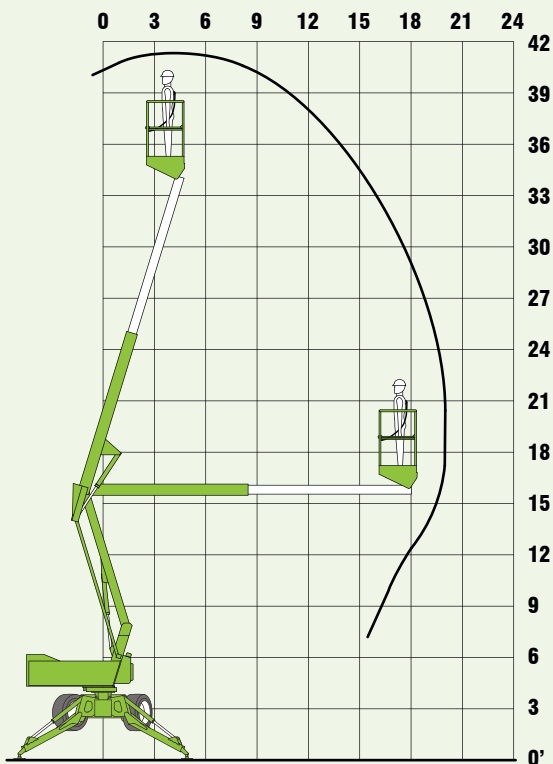
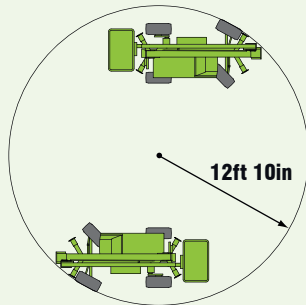

Due to a policy of continuing development and improvement, Niftylift reserves the right to change any specification without notice. Please confirm exact specification before ordering.



Niftylift's highly effective **Bi-Energy** system increases flexibility and maximizes utilization allowing the **SD34T** to operate for longer and in a wider range of environments.

SPECIFICATIONS

Working Height	41ft 7in
Platform Height	35ft
Working Outreach	20ft
Slew	406°
Width - Travelling	5ft 3in
- Working	10ft 6in
Height	6ft 7in
Length	12ft 10in
Minimum Weight	4980lbs*
Turning Radius - Outside	12ft 10in
Platform Capacity	500lbs
Platform Size	3ft 7in x 2ft 2in
Drive Speed	6.2mph
Gradeability	45%
Control System	Fully Proportional Hydraulic
Power Options	Battery Only Gas or Diesel Only Bi-Energy (Engine and Battery)

* Weights may vary according to specification / power options, please confirm before ordering.

Supplied by:

NIFTYLIFT INC

32 Concourse Way,
Greer, SC 29650 USA
Sales: 1-800-NIFTYLIFT (800-643-8954)
Office: 1-877-MYNIFTY (877-696-4389)
Fax: 1-864-968-8836
e.mail: info@niftylift.com
www.niftylift.com

NIFTYLIFT LTD

Fingle Drive, Stonebridge
Milton Keynes, MK13 0ER
England, United Kingdom
Tel.: +44 (0)1908 223456
Fax.: +44 (0)1908 312733
e.mail: info@niftylift.com
www.niftylift.com