

REVISIONS					
LTR	ECO	DESCRIPTION	DATE	APPROVED	ZONE
A		INITIAL RELEASE	1/18/2016	RWW	
B		REV_TITLE_BLOCK_ADD_UNROLL_DIRECTION	3/28/2016	RWW	

NOTES:
XXXXX

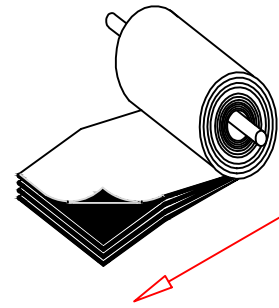

THESE INSTRUCTIONS
ARE FOR UNROLLING FROM
THE BOTTOM OF THE ROLL

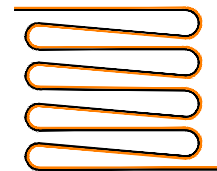

PIECE 1

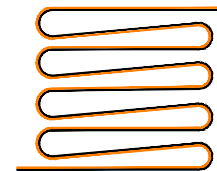
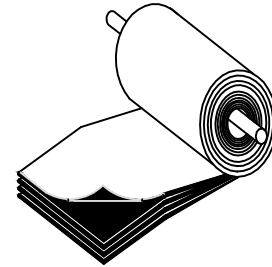

PIECE 2

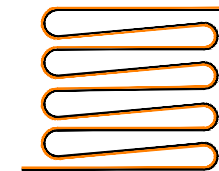
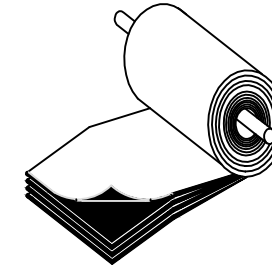

PIECE 3

← UNFOLD

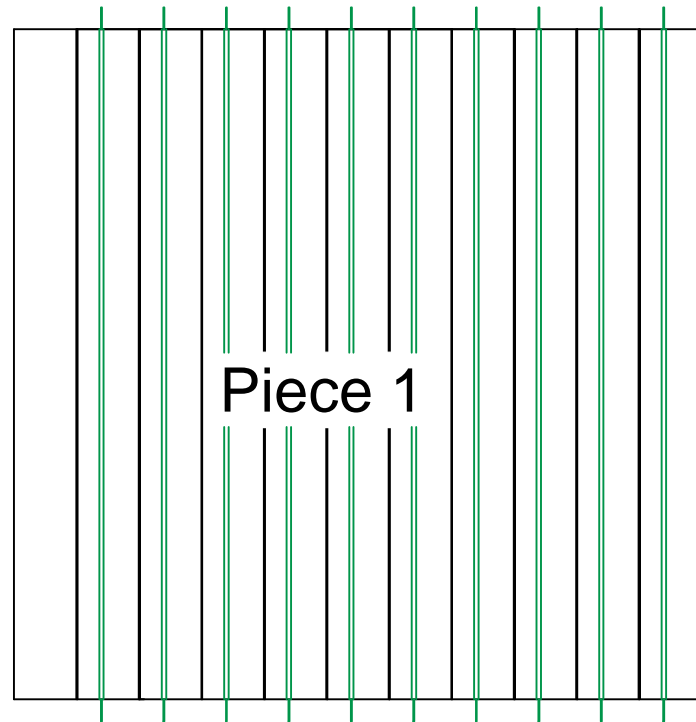

UNFOLD →

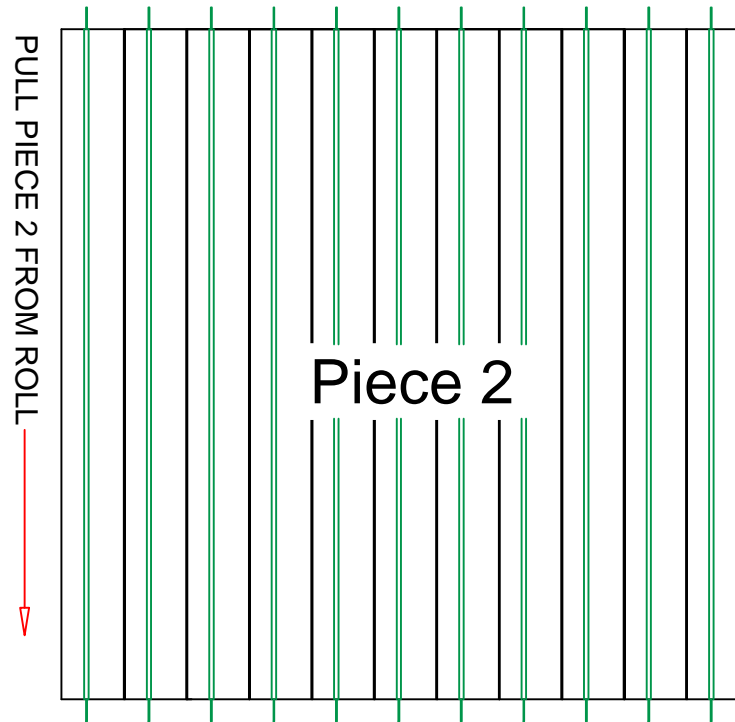

UNFOLD →

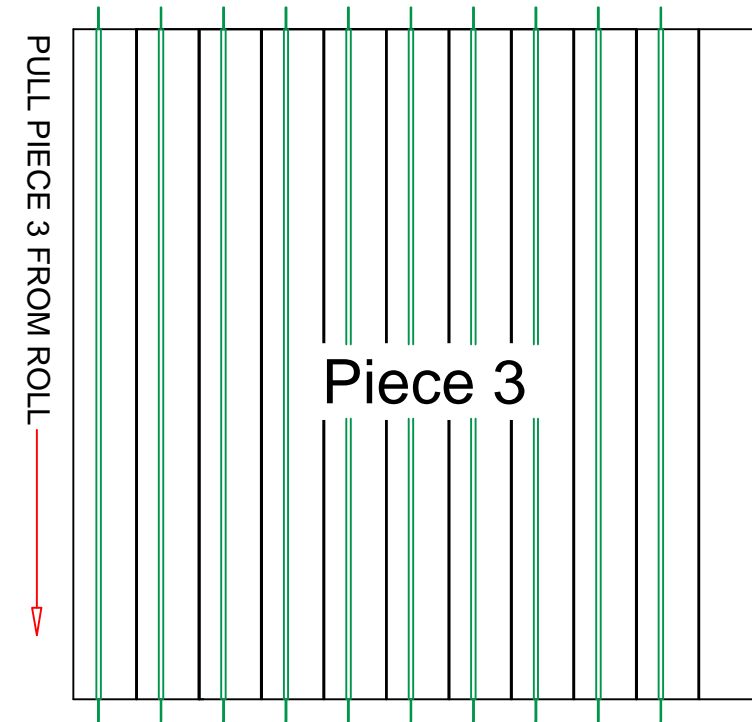

DEPLOYMENT INSTRUCTIONS;

1. PULL PIECE 1 & 2 ACROSS THE GRAIN PILE ABOUT 1/3 OF THE WAY FROM THE STARTING END
2. SEW PANELS AS SHOWN ON PAGE 2 AND 3 OF THESE INSTRUCTIONS
3. WHILE HOLDING PIECE 2, UNFOLD PIECE 1 TO THE STARING END OF THE BUNKER
4. UNFOLD PIECE 2
5. UNROLL PIECE 3 ACROSS PILE
6. SEW PIECE 2 AND 3 AS SHOWN ON PAGE 2 AND 3 OF THESE INSTRUCTIONS
7. UNFOLD PIECE 3 TO THE END OF THE BUNKER

FOR FURTHER INSTRUCTIONS VISIT ravenefd.com/installation

		COVER TYPE			
		OVAL 3 PIECE with Strap Accordion Folded Page 1 of 3			
RAVEN ENGINEERED FILMS PO BOX 5107 SIOUX FALLS, SD 57117-5107 +1 (800) 635-3456		SIZE	SALES ORDER	DRAWING NUMBER	REV
DRAWN	RWW	DATE	1/18/2016	B	O3STAS
DO NOT SCALE DRAWING		PROPRIETARY AND CONFIDENTIAL INFORMATION OF RAVEN INDUSTRIES INC. THIS DRAWING AND THE INFORMATION HEREON ARE RAVEN INDUSTRIES INC. PROPERTY AND MAY BE USED BY OTHERS ONLY AS AUTHORIZED IN WRITING BY RAVEN INDUSTRIES INC. - ALL RIGHTS RESERVED UNDER THE COPYRIGHT LAWS.			

REVISIONS					
LTR	ECO	DESCRIPTION	DATE	APPROVED	ZONE
A		INITIAL_RELEASE	1/18/2016	RWW	
B		REV_TITLE_BLOCK	3/28/2016	RWW	

NOTES:
XXXXX

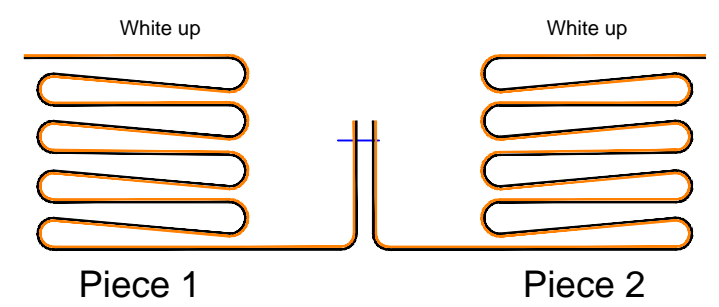

FIGURE 1

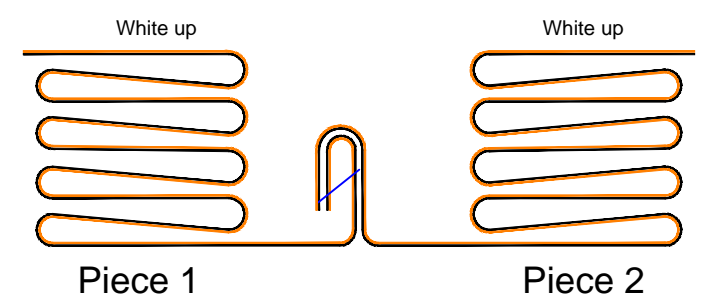

FIGURE 2

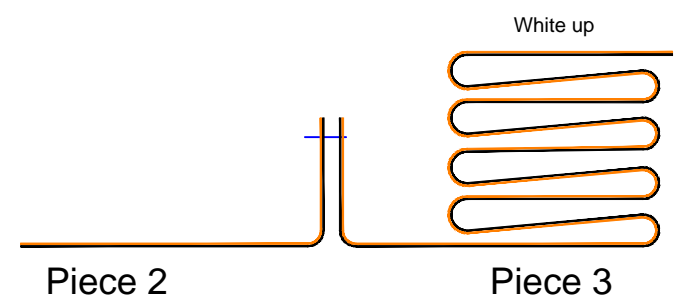

FIGURE 3

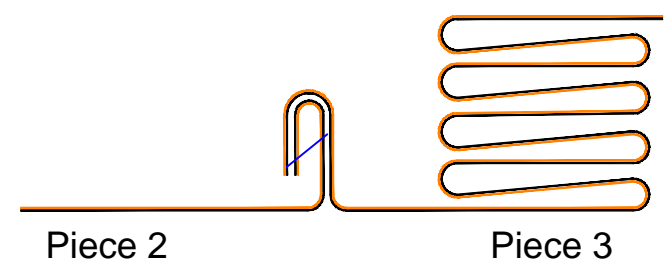

FIGURE 4

SEWING INSTRUCTIONS

1. ONCE FIRST AND SECOND PIECE ARE UNROLLED, BRING THE BOTTOM OF BOTH PIECES TOGETHER BLACK TO BLACK, (FIGURE1)
2. SEW ACROSS THE ENTIRE SEAM AS SHOWN IN THE GENERAL SEWING INSTRUCTIONS, (PAGE 3)
3. FOLD THE SEAM OVER AND SEW THE ENTIRE SEAM AS SHOWN IN THE GENERAL INSTRUCTIONS, (FIGURE 2)
4. ONCE PIECE 3 IS UNROLLED, BRING THE BOTTOM OF BOTH PIECES TOGETHER BLACK TO BLACK, (FIGURE 3)
5. SEW ACROSS THE ENTIRE SEAM AS SHOWN IN THE GENERAL SEWING INSTRUCTIONS, (PAGE 3)
6. FOLD THE SEAM OVER AND SEW THE ENTIRE SEAM AS SHOWN IN THE GENERAL INSTRUCTIONS, (FIGURE 4)
FOR FURTHER INSTRUCTIONS VISIT ravenefd.com/installation

	COVER TYPE		
	OVAL 3 PIECE with Straps Accordion Folded		
RAVEN ENGINEERED FILMS PO BOX 5107 SIOUX FALLS, SD 57117-5107 +1 (800) 635-3456	SALES ORDER	DRAWING NUMBER	REV
DRAWN: RWW NAME: RWW DATE: 1/18/2016	1	O3STAS	B
PROPRIETARY AND CONFIDENTIAL INFORMATION OF RAVEN INDUSTRIES INC. THIS DRAWING AND THE INFORMATION HEREON ARE RAVEN INDUSTRIES INC. PROPERTY AND MAY BE USED BY OTHERS ONLY AS AUTHORIZED IN WRITING BY RAVEN INDUSTRIES INC. - ALL RIGHTS RESERVED UNDER THE COPYRIGHT LAWS.			

DO NOT SCALE DRAWING

8

7

6

5

4

3

2

1

REVISIONS					
LTR	ECO	DESCRIPTION	DATE	APPROVED	ZONE
A		INITIAL_RELEASE	1/18/2016	RWW	
B		REV_TITLE_BLOCK	3/28/2016	RWW	

NOTES:

XXXXX

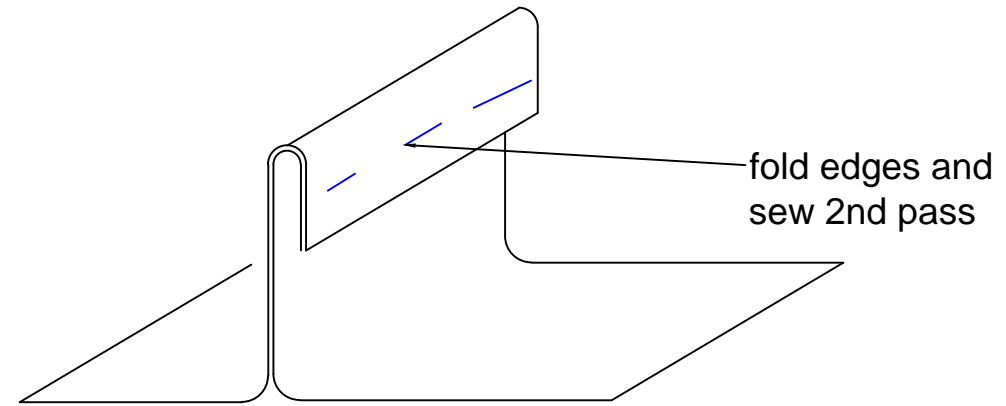
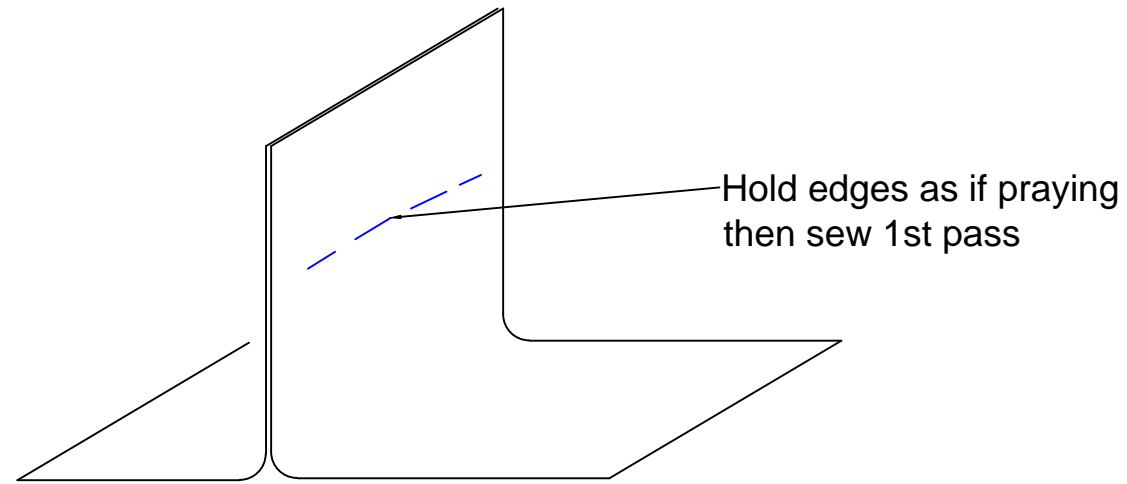

GENERAL SEWING INSTRUCTIONS

1. WHEN SEWING MAKE ABOUT A 15 FOOT PASS THEN PULL OUT AND RESTART SEWING ABOUT 3" BEHIND WHERE YOU PULLED OUT. THIS WILL LIMIT THE AMOUNT OF SEWING THAT CAN COME LOOSE FROM A POOR SEAM. DO THIS OVER THE ENTIRE LENGTH TO BE SEWN.
2. FOLD THE SEAM OVER AND REPEAT STEP 1 ACROSS THE ENTIRE LENGTH OF THE SEAM.

		COVER TYPE			
		GENERAL SEWING INSTRUCTIONS Page 3 of 3			
RAVEN ENGINEERED FILMS PO BOX 5107 SIOUX FALLS, SD 57117-5107 +1 (800) 635-3456		SIZE	SALES ORDER	DRAWING NUMBER	REV
DRAWN	RWW	DATE	1/18/2016	B	'
DO NOT SCALE DRAWING		PROPRIETARY AND CONFIDENTIAL INFORMATION OF RAVEN INDUSTRIES INC. THIS DRAWING AND THE INFORMATION HEREON ARE RAVEN INDUSTRIES INC. PROPERTY AND MAY BE USED BY OTHERS ONLY AS AUTHORIZED IN WRITING BY RAVEN INDUSTRIES INC. - ALL RIGHTS RESERVED UNDER THE COPYRIGHT LAWS.			

8

7

6

5

4

3

2

1