

		REVISIONS			
LTR.	ECO	DESCRIPTION	DATE	APPROVED	ZONE
A		INITIAL RELEASE			
B		REV. TITLE BLOCK ADDED, PULL DIRECTION	3/28/2016	RWW	

NOTES:  
1. XXXXX

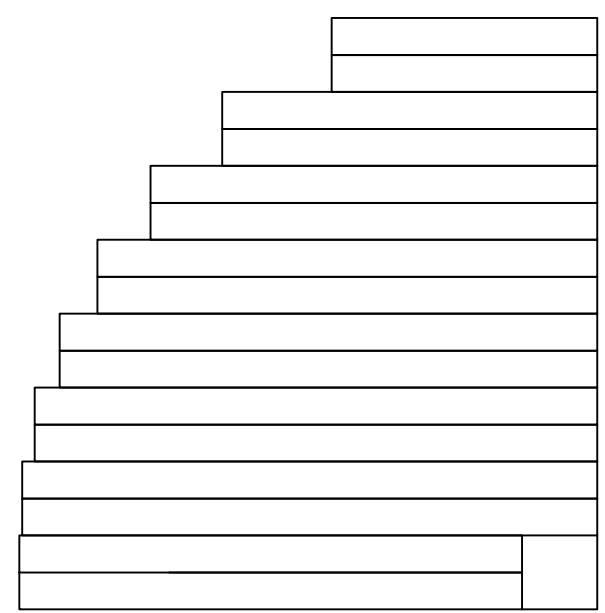

UNROLL\*

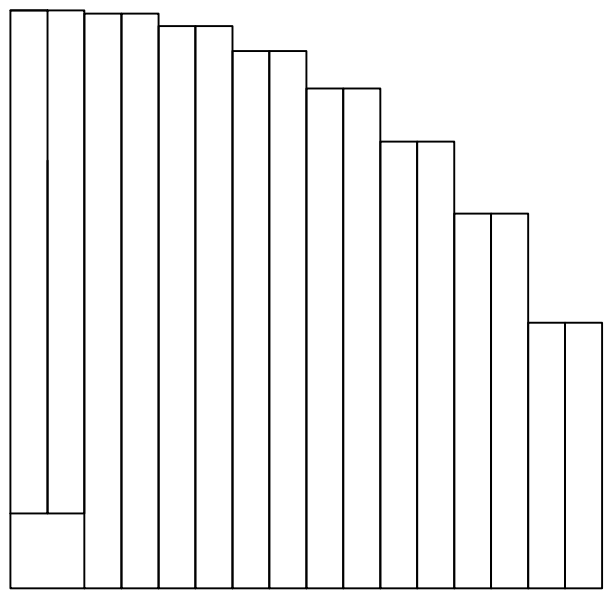

UNROLL\*

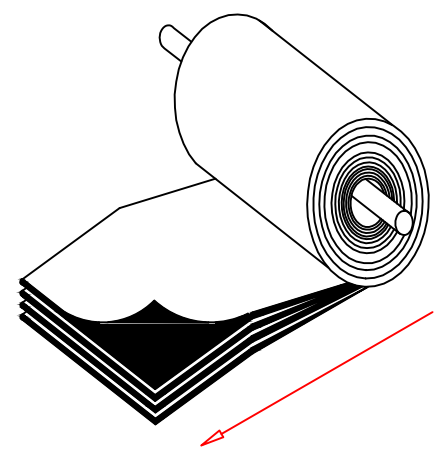

THESE INSTRUCTIONS  
ARE FOR UNROLLING  
FROM THE BOTTOM OF  
THE ROLL

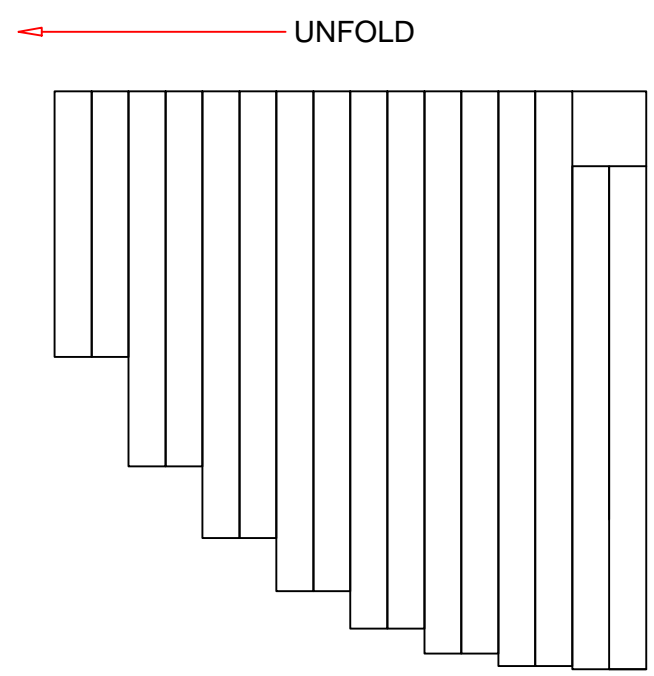

UNROLL\*

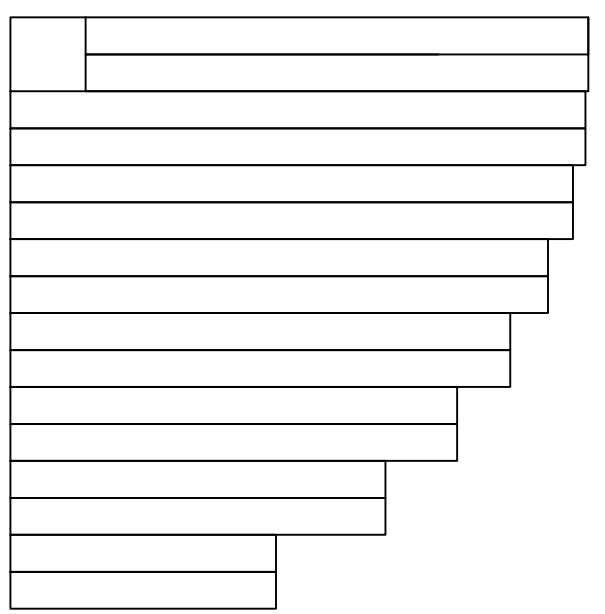

UNROLL\*

PLEASE NOTE;

- IF COVERING YOUR GRAIN STORAGE SYSTEM WHEN FILLED, DISPENSE ROLLS FROM THE SIDE OF THE BUNKER AND PULL TOWARD THE CENTER OF THE PILE.
  - IF FILLING YOUR GRAIN STORAGE SYSTEM AFTER INSTALLATION OF THE COVER, PLACE YOUR ROLLS INSIDE THE WALLS ON THE GROUND ALONGSIDE THE TOWER, ATTACH TO THE TOWER AND UNROLL TOWARD THE BUNKER WALLS.
- FOR FURTHER INSTRUCTIONS VISIT [ravenefd.com/installation](http://ravenefd.com/installation)

**RAVEN**

RAVEN ENGINEERED FILMS  
PO BOX 5107  
SIOUX FALLS, SD 57117-5107  
+1 (800) 635-3456

NAME	DATE
RWW	1/28/2016

DRAWN

COVER TYPE  
**CIRCULAR 4 PIECE Accordion Folded Straight Cut, Sew Together, Page 1 of 2**

SIZE	SALES ORDER	DRAWING NUMBER	REV
B	I	C4NOAS	B

PROPRIETARY AND CONFIDENTIAL INFORMATION OF RAVEN INDUSTRIES INC.  
THIS DRAWING AND THE INFORMATION HEREON ARE RAVEN INDUSTRIES INC. PROPERTY AND MAY BE USED BY OTHERS ONLY AS AUTHORIZED IN WRITING BY RAVEN INDUSTRIES INC.  
- ALL RIGHTS RESERVED UNDER THE COPYRIGHT LAWS.

DO NOT SCALE DRAWING

REVISIONS					
LTR.	ECO	DESCRIPTION	DATE	APPROVED	ZONE
A		INITIAL_RELEASE	1/28/2016	RWW	
B		REV_TITLE_BLOCK	3/28/2016	RWW	

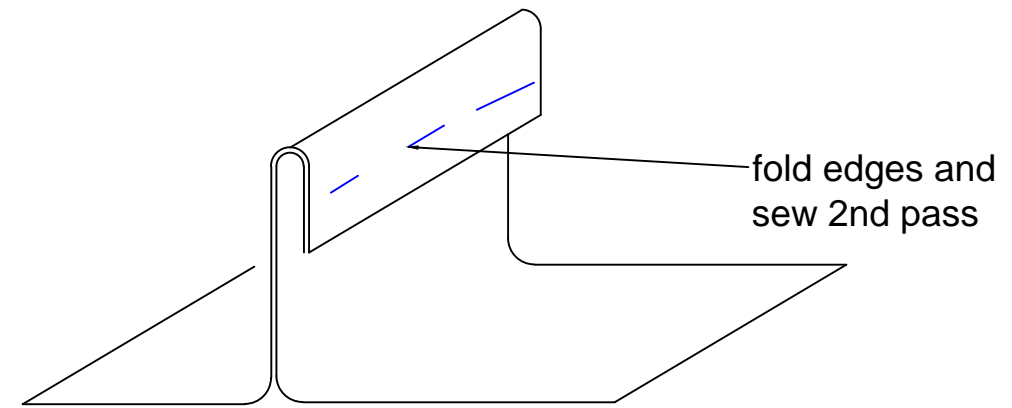
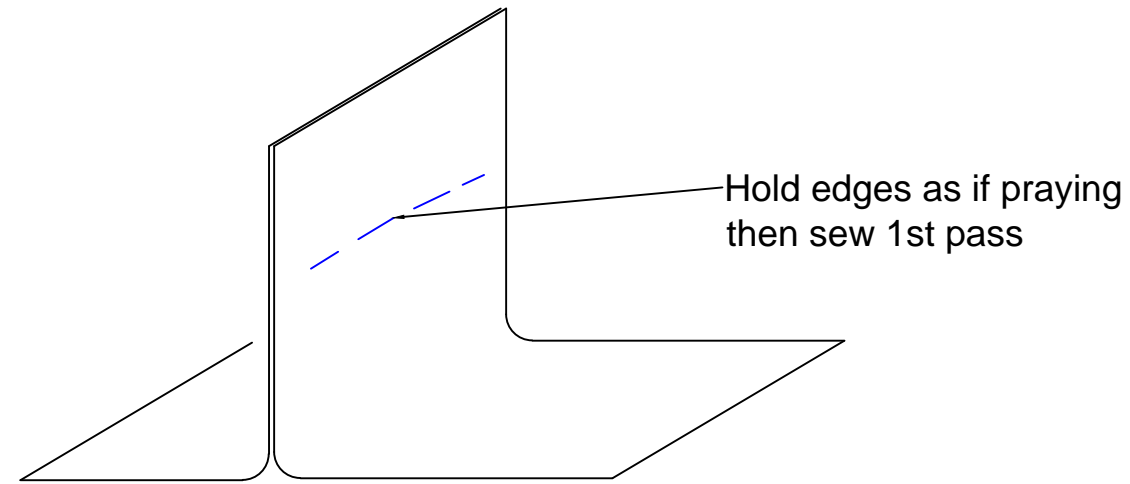

**GENERAL SEWING INSTRUCTIONS**

1. WHEN SEWING MAKE ABOUT A 15 FOOT PASS THEN PULL OUT AND RESTART SEWING ABOUT 3" BEHIND WHERE YOU PULLED OUT. THIS WILL LIMIT THE AMOUNT OF SEWING THAT CAN COME LOOSE FROM A POOR SEAM. DO THIS OVER THE ENTIRE LENGTH TO BE SEWN.
2. FOLD THE SEAM OVER AND REPEAT STEP 1 ACROSS THE ENTIRE LENGTH OF THE SEAM.

		COVER TYPE			
		GENERAL SEWING INSTRUCTIONS Page 2 of 2			
RAVEN INDUSTRIES, INC. PO Box 5107 Sioux Falls, SD 57117-5107 +1 (800) 635-3456		SIZE	SALES ORDER	DRAWING NUMBER	REV
DRAWN	RWW	DATE	1/28/2016	B	'
DO NOT SCALE DRAWING		PROPRIETARY AND CONFIDENTIAL INFORMATION OF RAVEN INDUSTRIES INC. THIS DRAWING AND THE INFORMATION HEREON ARE RAVEN INDUSTRIES INC. PROPERTY AND MAY BE USED BY OTHERS ONLY AS AUTHORIZED IN WRITING BY RAVEN INDUSTRIES INC. - ALL RIGHTS RESERVED UNDER THE COPYRIGHT LAWS.			