

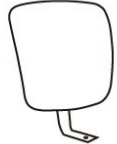









(1)x1  Back Cushion	(2)x1  Seat Cushion	(3)x1 (L)x1 (R)  Left-Arm-L Right-Arm-R
(4)x1  Gas Lift W/ Cover	(5)x1  Base	(6)x 5  Caster
(7)x1 		
(A)*2   M6*25 Arm Screws		
(B)*4   M6*40 Arm Screws		

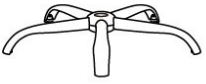

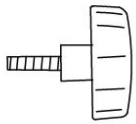
Insert and loosely tighten all screws. When assembly is completed, fully tighten all screws before using. This chair is only intended for sitting. Any other use will void the warranty.

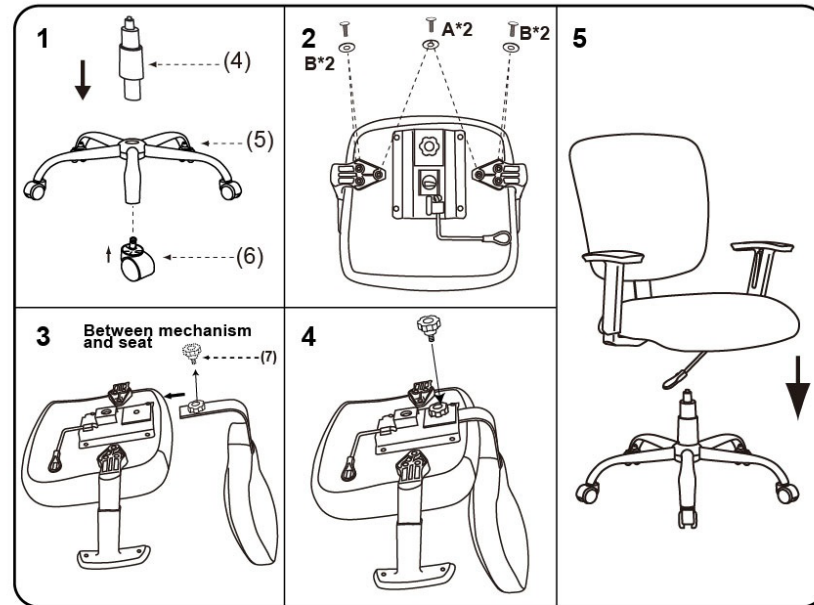