

This assembly manual contains important safety information. Please read and keep for future reference.

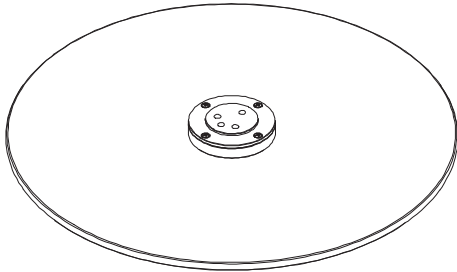

Model No.: OSGT24RCLEARCL / OSGT36RCLEARCL
Description: Clear Glass Table Top w/ Metal Adapter

Useful Hints Before You Start

1. Read each step carefully before starting.
2. Before beginning assembly, identify, sort and count the parts before assembly.
3. Using the wrong screw will cause damage.
4. Using incompatible hardware might cause damage to product.
5. It is important that each step is performed in correct order to avoid difficulties.
6. Assemble your furniture on packaging cardboard to prevent scratch or damage.
7. Do not tighten any screws or bolt until the unit is completely assembled.
8. Keep all hardware parts out of reach of children.

Necessary Tools



Phillips
Screwdriver



Flat Head
Screwdriver



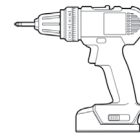

Hammer



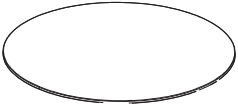

CAUTION!
Risk of product damage.
Power Drill can be used on lowest
torque setting.

Please read completely through the instructions and verify that all listed parts and hardware are present before beginning assembly.

Parts List

<p>A</p>  <p>OSGT24RCLEARCL or OSGT36RCLEARCL (x1)</p>	<p>B</p>  <p>OS Base (x1) (Sold Separately)</p>	<p>C</p>  <p>OS Post (x1) (Sold Separately)</p>
--	---	---

Hardware List

<p>1</p>  <p>Handle Screws (x4)</p>	<p>2</p>  <p>Allen Key(x1)</p>
---	--

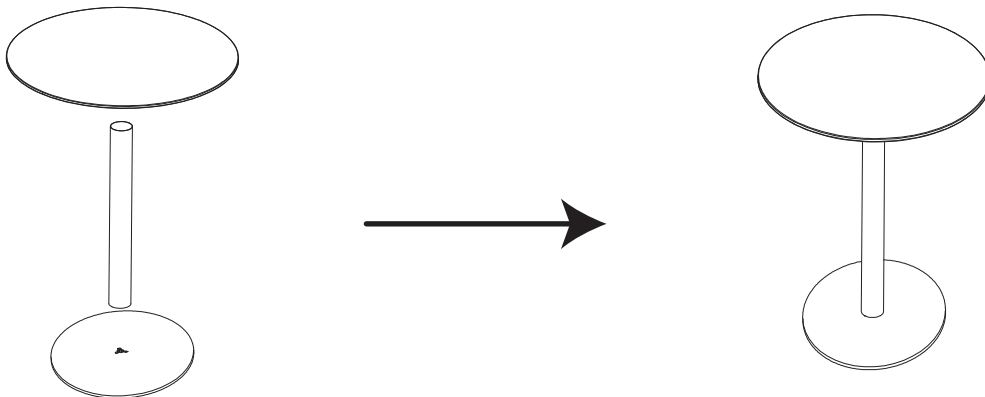

1. Remove the Handle Screws(1) from OSGT24RCLEARCL/OSGT36RCLEARCL(A) with the Allen Key(2).

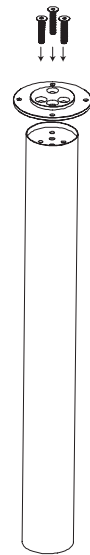
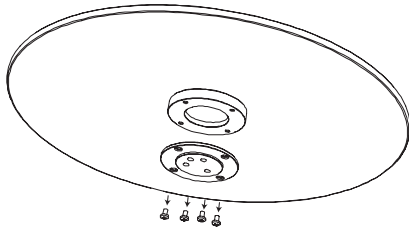

Pre-installed Bolts(x3) on OS Post(C).

2. Attach the adapter to the top of the OS Post(C), then tighten the pre-installed bolts with the Allen Key(2).

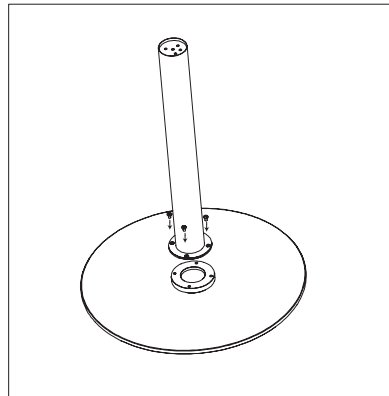

3. Attach the OS Post(C) to the OSGT24RCLEARCL/OSGT36RCLEARCL(A) with the Handle Screws(1) and Allen Key(2).

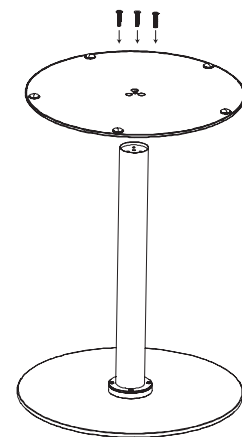

4. Attach the OS Base(B) to the OS Post(C) using the 3 pre-installed bolts and the Allen Key(2).

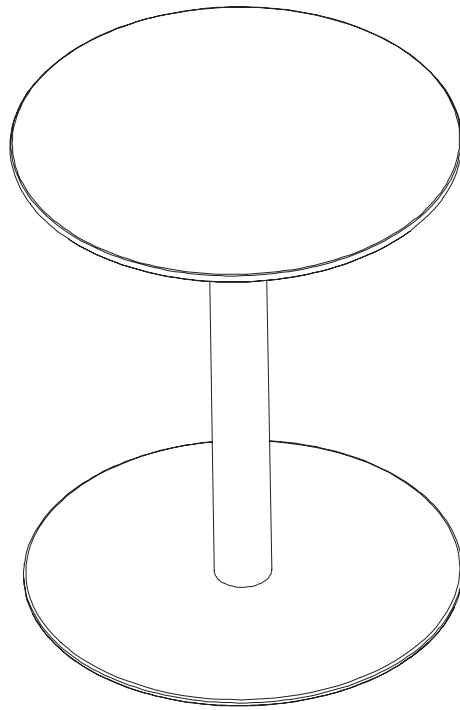

Care & Maintenance

- Check bolts/screws periodically and tighten them if necessary.
- Use a soft, clean cloth that will not scratch the surface when dusting.
- Clean the product with mild cleanser using soft damp cloth. Do not use harsh or abrasive cleanser.
- Liquid spills should be removed immediately. Using a soft clean cloth, blot the spill gently.
- Heat can cause chemical changes that may create spotting within furniture finish.
- It is best to keep your furniture in a climate-controlled environment. Extreme temperature and humidity changes can cause fading, warping, shrinking and splitting of wood. It is advised to keep furniture away from direct sunlight as sun may damage the finish.