

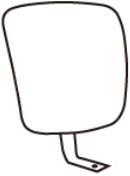





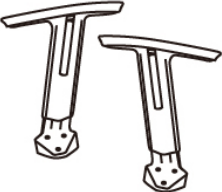
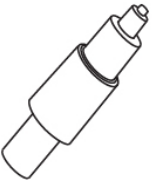
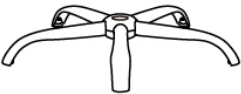

MODEL:6801FPBLK 6801C

(1)x1  Back Cushion	(2)x1  Seat Cushion	(3)x1 (L)x1 (R)  Left-Arm-L Right-Arm-R
(4)x1  Gas Lift W/ Cover	(5)x1  Base	(6)x5  Caster
(7)x1 		
(A)*2   M6*25 Arm Screws		
(B)*4   M6*40 Arm Screws		

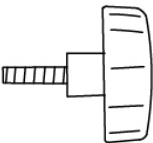

Insert and loosely tighten all screws. When assembly is completed, fully tighten all screws before using. This chair is only intended for sitting. Any other use will void the warranty.

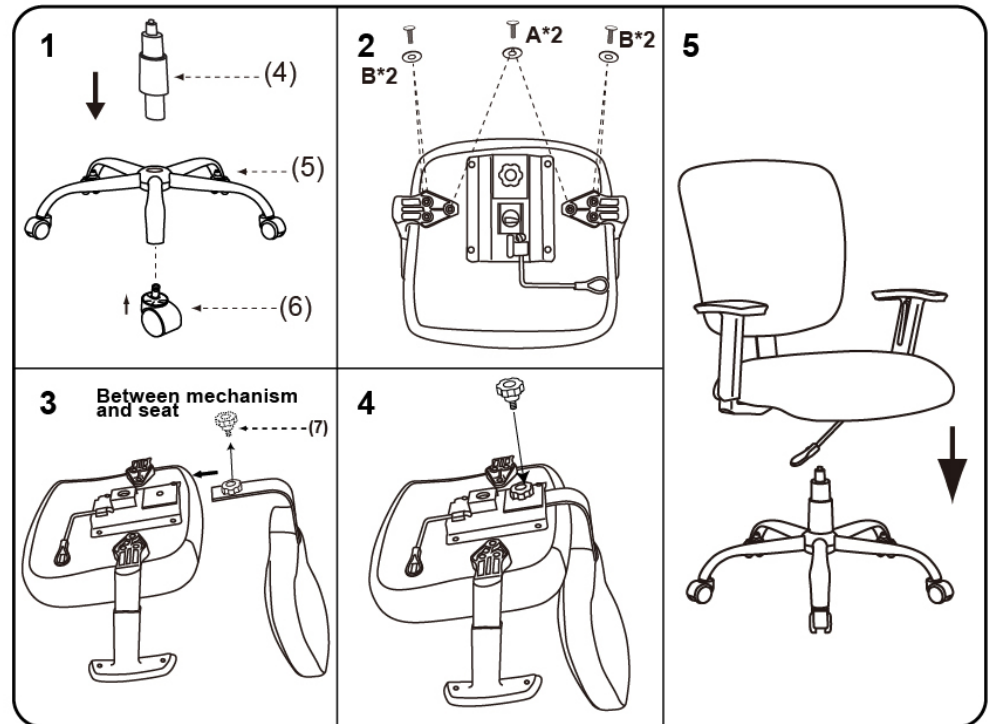