

AL001 UNIVERSAL MANUAL CARRIER



INSTALLATION/ OWNER'S MANUAL



TABLE OF CONTENTS

SAFETY 4
 Safety Definition 4

INTRODUCTION 5
 Device Name: AL001 5
 Read and Understand 5
 Technical Specifications 5
 Lift Elements 6

PREPARATION 7
 Required Tools 7

INSTALLATION 8
 Anti-tilt Locking Device Installation 9

WARRANTY 10

SAFETY

SECTION 1

SAFETY

SAFETY DEFINITIONS



This safety alert symbol appears with safety statements. It means attention, become alert, your safety and the safety of others are involved! Please read and abide by the message that follows the safety alert symbol.

WARNING

Indicates a hazardous situation that, if not avoided, could result in death or serious injury.

CAUTION

Indicates a hazardous situation that, if not avoided, could result in minor or moderate injury.

NOTICE

Indicates a situation which can cause damage to the lift and/or the environment, or cause the lift to operate improperly.

NOTE: Indicates a condition that should be followed in order for the lift to function in the manner intended.

If you do not understand any portion of the installation or operation procedures, please consult Harmar's Technical Service Department at 800-833-0478. Do not attempt to install or use this lift if you have any hesitation or question. Serious injury or damage can result if proper procedures are not followed.

SECTION 2

INTRODUCTION

DEVICE NAME: AL001

Indications of Use: The intended use of the AL001 is to lift, secure and transport an unoccupied mobility device for patients or mobility-impaired persons.

READ AND UNDERSTAND

Read and understand this manual prior to installation. Having an overall understanding of the lift and proper installation techniques will help save time, energy and avoid possible injury.

This manual provides instructions for proper installation and operation of an AL001. Please refer to the Owner's Manual for operating instructions. Be sure to provide the Installation/Owner's Manual to the owner of the lift before it is put into service. Any alterations to the equipment without written authorization by the manufacturer may void the warranty.

TECHNICAL SPECIFICATIONS

Visit harmar.com for specifications on the specific lift model and configuration.

LIFT ELEMENTS

1. Ramp
2. Ramp bolt sets (2)
3. Carriage bolt sets (2)
4. Ramp bracket
5. Spring pull pin (2)
6. Reflector (2)
7. Carrier tray
8. Gear
9. Hitch pin
10. M12x70 bolt
11. Adjust bolt
12. M10x30 bolt (3)
13. Anti-tilt lock bracket
14. Lock bolt (4)

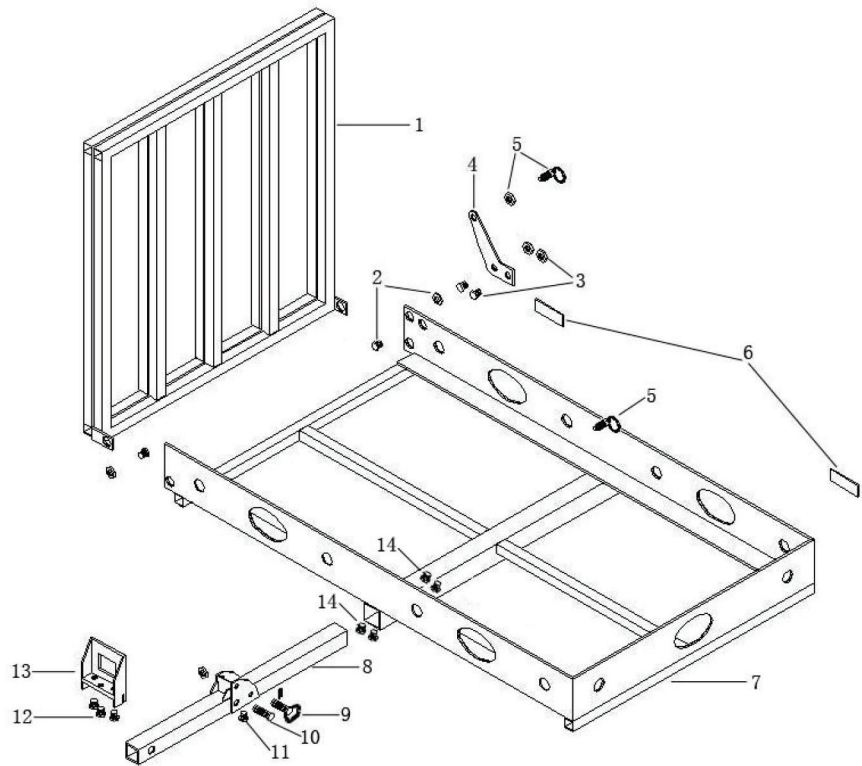

SECTION 3

PREPARATION

If you have any questions, concerns or comments, please contact our Technical Service Department at 800-833-0478 or tech@harmar.com.

REQUIRED TOOLS

- Wrench Set:
 - Imperial
 - Metric
- No. 2 Phillips Head Screwdriver

SECTION 4 **INSTALLATION**

1. Insert the hitch into the carrier rack.
See Figure 4-1.

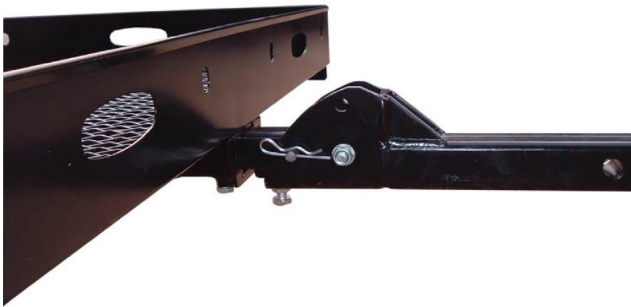

Figure 4-1

2. Insert four (4) lock bolts on the bottom of your carrier tube. Tighten bolts firm with a wrench. *See Figure 4-2.*

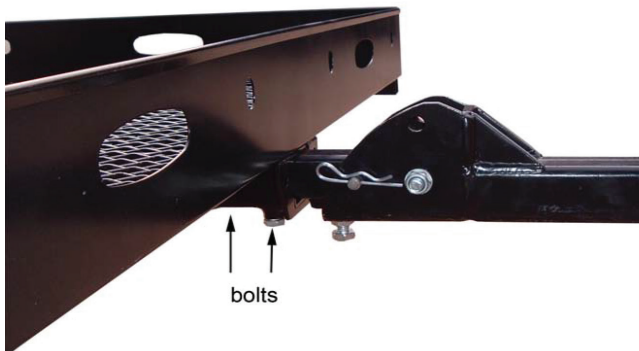

Figure 4-2

3. Screw spring pull pin into carrier. Add reflectors. *See Figure 4-3.*

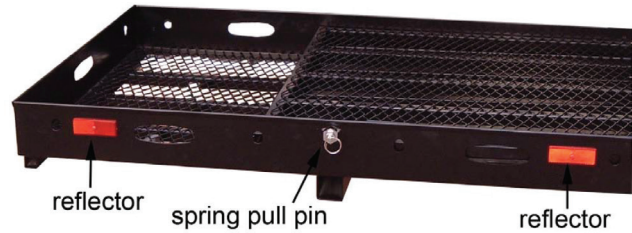

Figure 4-3

4. Screw spring pull pin into jam nut. Screw spring pull pin into ramp bracket. Bolt bracket to frame and secure with nuts and lock washers. *See Figure 4-4.*

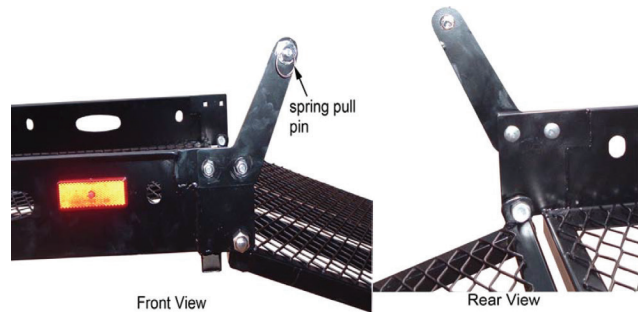

Figure 4-4

NOTICE

To prevent loosening of the spring pull pin, torque the jam nut tightly against the ramp bracket.

- When in use: Use the safety pin to adjust the hitch. *See Figure 4-5.*

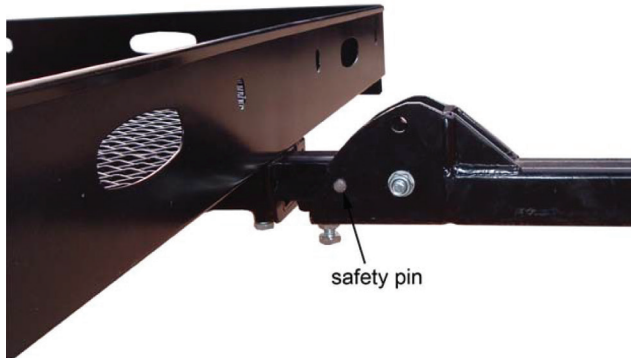

Figure 4-5

- Insert the spring pull pin into the hole to the ramp when you fold up the ramp. *See Figure 4-6.*



Figure 4-6

ANTI-TILT LOCKING DEVICE INSTALLATION

- Loosen the bolts on the anti-tilt lock bracket. There should be grooves where the bolts were tightened against the hitch receiver. *See Figure 4-7.*

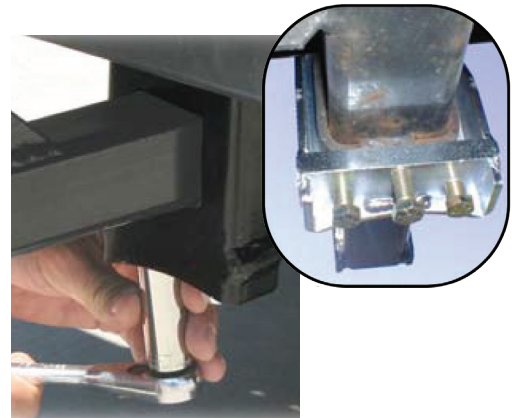

Figure 4-7

NOTE: This procedure is required only during the initial installation of the anti-tilt lock bracket as the grooves will ensure repeatable relocation of the anti-tilt lock bracket.

- Now pull the carrier out to its final location and install the hitch pin. Return the anti-tilt lock bracket to the location securely against the hitch receiver and torque the bolts. The bolts should fall into the grooves created earlier.

WARNING

For the installation of the anti-tilt lock bracket, insert the carrier into the hitch receiver, Do not insert the hitch pin at this point. Now slide the carrier toward the vehicle until it holds the anti-tilt lock bracket while an additional person holds the carrier securely against the hitch receiver. Be sure to torque the bolts to 35'-40' lb.

WARNING

Large chain loops on trailer hitches will not accept the anti-tilt locking device. In this case you will be unable to use the supplied anti-tilt locking device.

WARRANTY



SECTION 5

1-YEAR LIMITED WARRANTY

PRODUCT COVERED: AL001

Your lift came with a separate warranty page on page 11. You must return this page within ten (10) days of installation to register your lift. This warranty policy page must remain in your Owner’s Manual for your records. Do not tear out this page.

Dealer/Installer Name: _____

Address: _____

Phone: _____

E-Mail: _____

If you need service or warranty work, your dealer will require the information below to receive factory information or order parts for your lift.

Date Installed: _____

Serial # of the Lift: _____

THIS EXPRESS WARRANTY IS IN LIEU OF ALL OTHER WARRANTIES OR CONDITIONS, INCLUDING ALL IMPLIED WARRANTIES OR MERCHANTABILITY OR FITNESS FOR A PARTICULAR PURPOSE, AND THERE ARE NO WARRANTIES THAT EXTEND BEYOND THE DESCRIPTION OF THE LIMITED WARRANTY DESCRIBED HEREIN. THIS WARRANTY GIVES YOU SPECIFIC LEGAL RIGHTS AND YOU MAY ALSO HAVE OTHER LEGAL RIGHTS WHICH VARY FROM STATE TO STATE.

Harmar Mobility warrants to the original purchaser of an AL001 sold by Harmar to be free of defects in material, mechanical and electrical components (parts), excluding labor cost, batteries, paint, rust and covers, for a period of one (1) year from date

of retail purchase, provided that the products have been installed, maintained and operated properly. Harmar and its dealers shall not be liable for any consequential, special or incidental damages arising out of the purchase or use of the unit or resulting from the breach of this Limited Warranty, or any implied warranty. This warranty is not transferable.

This warranty does not cover defects in vehicles on which Harmar products are installed or malfunctions in Harmar products caused by defects in any part of the vehicle. All warranty claims must be reported to the dealer from whom the lift was purchased as they have responsibility for handling warranty claims.

The dealer is to contact the Technical Services Department of Harmar and provide the serial number of the product along with a description and evidence of the defect(s) supporting a warranty claim. Dealers may charge for labor, service, travel, or other associated costs to make repairs, and such charges are not covered by this Limited Warranty. It is permissible to have any repairs or replacement work done as a result of any defects in material and workmanship by someone other than the Dealer under this Limited Warranty. All parts used to replace defective materials must be genuine Harmar parts to be covered by this Limited Warranty.

This Limited Warranty grants specific legal rights, other rights vary from state to state. Harmar will not be charged for labor, consequential damage or repair expenses. Harmar will not, under any circumstances, be liable for the loss of the use of its products or loss of time. Defective parts must be returned, if requested, prepaid, to Harmar for inspection prior to credit or replacement. At Harmar’s discretion, any part found to have been modified, over-stressed, damaged by accident, or misused is not covered by this warranty.

PLEASE FILL OUT ALL FIELDS AND RETURN WITHIN TEN (10) DAYS OF PRODUCT INSTALLATION.

Fax completed form to 1-866-234-5680 or mail to:
Harmar, ATTN Warranty Department, 1500 Independence Blvd, Ste 220, Sarasota Florida 34234.

PRODUCT INFORMATION

Model: _____

Serial Number: _____

Purchase Date: _____

Installation Date: _____

PURCHASER INFORMATION

Name: _____

Address: _____

Phone: _____

Email: _____

INSTALLER INFORMATION

Company Name: _____

Contact Name: _____

Address: _____

Phone: _____

Fax: _____

Email: _____

ADDITIONAL INFORMATION

How did you hear about Harmar?

- Harmar Dealer
- Internet
- Magazine
Which: _____
- Friend or Acquaintance
- Saw Harmar product somewhere
- Other: _____

APPLICATION INFORMATION

Scooter Power Wheelchair

Wheelchair N/A

Year: _____

Manufacturer: _____

Model: _____

I purchased my Harmar lift because of:

- Style/Appearance
- Harmar Representative
- Previous Experience
- Ease of Use
- Recommendation
- Price/Value



Page Intentionally Left Blank



1500 Independence Blvd, Suite 220
Sarasota, FL 34234
800.833.0478
harmar.com