

Data Sheet

Part No.	:	100001119_GW.26
Product Name	:	2.4GHz Miniature Terminal Mount Monopole Antenna (Wifi Only)
Features	:	SMA(M) Straight Connector, 50 Ohm 30mm Long RoHS Compliant
Suggested TCG-4	:	TCG-4 (WiFi Only)



1 Introduction

The GW.26 2.4GHz Monopole SMA(M) terminal mount antenna is ideal for 2.4GHz wireless applications such as Bluetooth and Wireless LAN.

Many module manufacturers specify peak gain limits for any antennas that are to be connected to that module. Those peak gain limits are based on free-space conditions. In practice, the peak gain of an antenna tested in free-space can degrade by at least 1 or 2dBi when put inside a device. So ideally you should go for a slightly higher peak gain antenna than mentioned on the module specification to compensate for this effect, giving you better performance.

Upon testing of any of our antennas with your device and a selection of appropriate layout, integration technique, or cable, we can make sure any of our antennas' peak gain will be below the peak gain limits. We can then issue a specification and/or report for the selected antenna in your device that will clearly show it complying with the peak gain limits, so you can be assured you are meeting regulatory requirements for that module.

For example, a module manufacturer may state that the antenna must have less than 2dBi peak gain, but you don't need to select an embedded antenna that has a peak gain of less than 2dBi in free-space. This will give you a less optimized solution. It is better to go for a slightly higher free-space peak gain of 3dBi or more if available. Once that antenna gets integrated into your device, performance will degrade below this 2dBi peak gain due to the effects of GND plane, surrounding components, and device housing. Choosing an antenna with a higher peak gain than what is specified by the module manufacturer and enlisting our help will ensure you are getting the best performance possible without exceeding the peak gain limits.

Connector mount is fully customizable.

2 Specification

Wi-Fi 2.4GHz	
Frequency	2400~2500MHz
Bandwidth	100MHz
Peak Gain	1.8dBi
Radiation Efficiency	> 40%
Radiation	Omni-directional
Polarization	Vertical
Power Handling 1W Max	Power Handling 1W Max
Electrical Wave	Monopole
Impedance	50Ω
Operating Temperature	-40°C ~ +85°C
Storage Temperature	-40°C ~ +85°C

3 Mechanical Properties

Mechanical Properties	
Colour	Black and Green
Connector	SMA(M)

4 Antenna Characteristics

4.1 Antenna S11

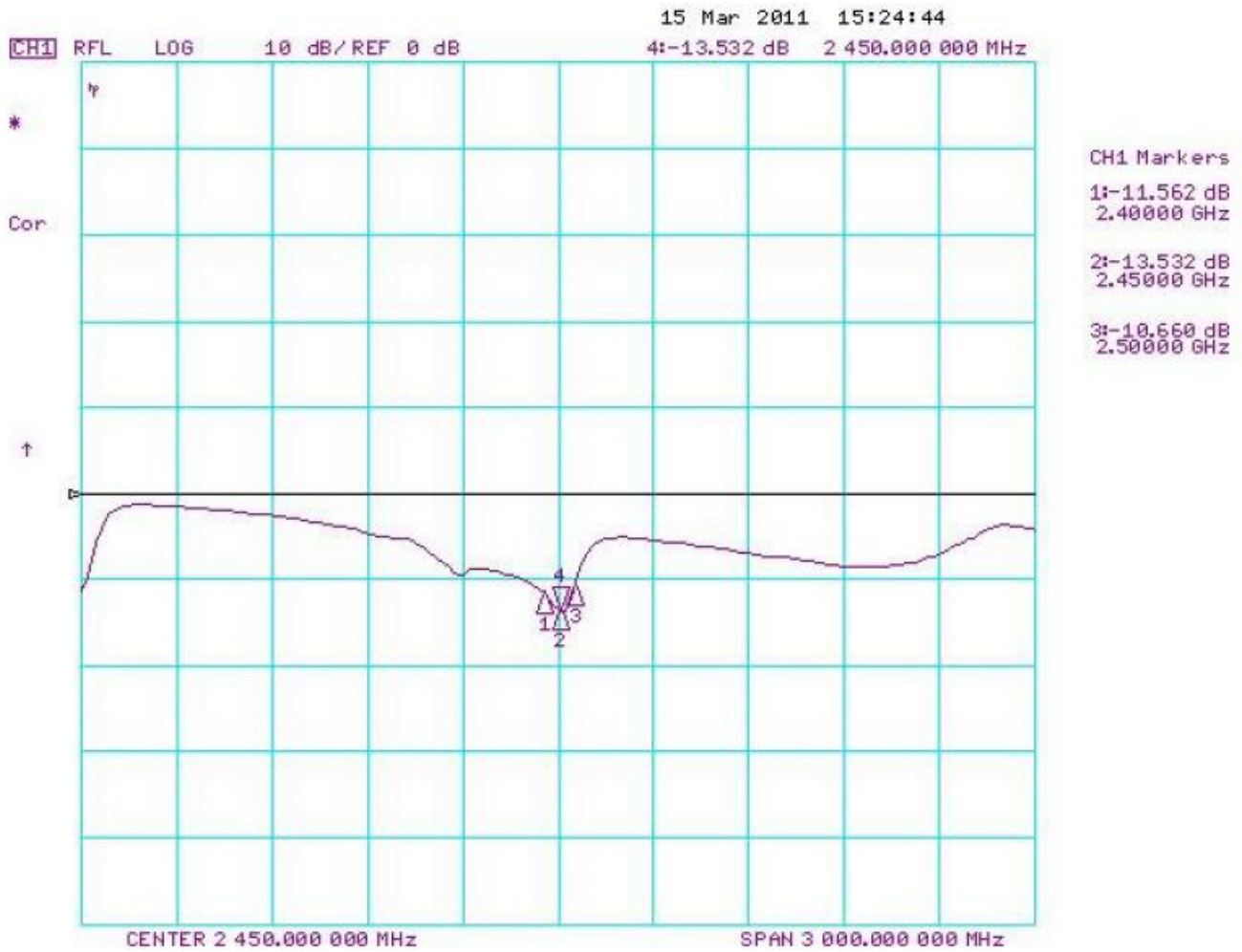

4.2 Antenna Peak Gain

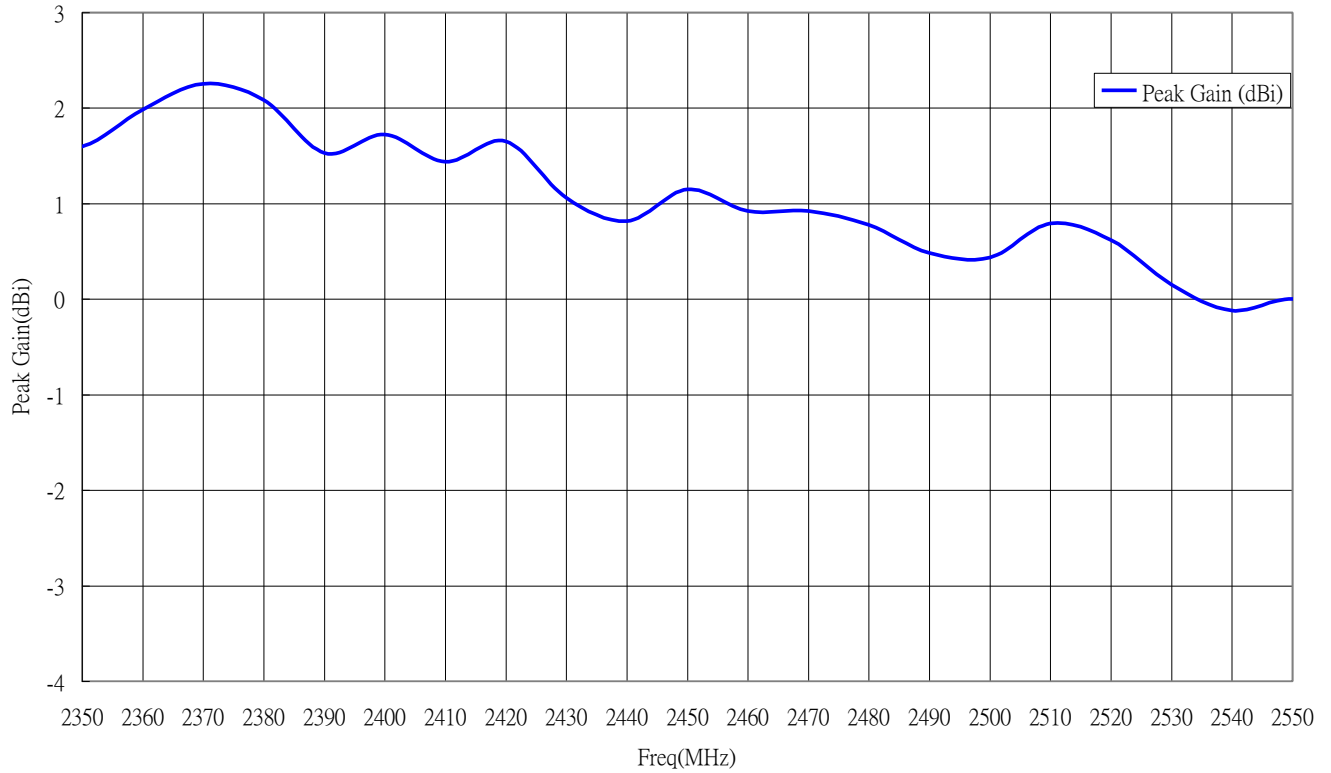

4.3 Antenna Efficiency

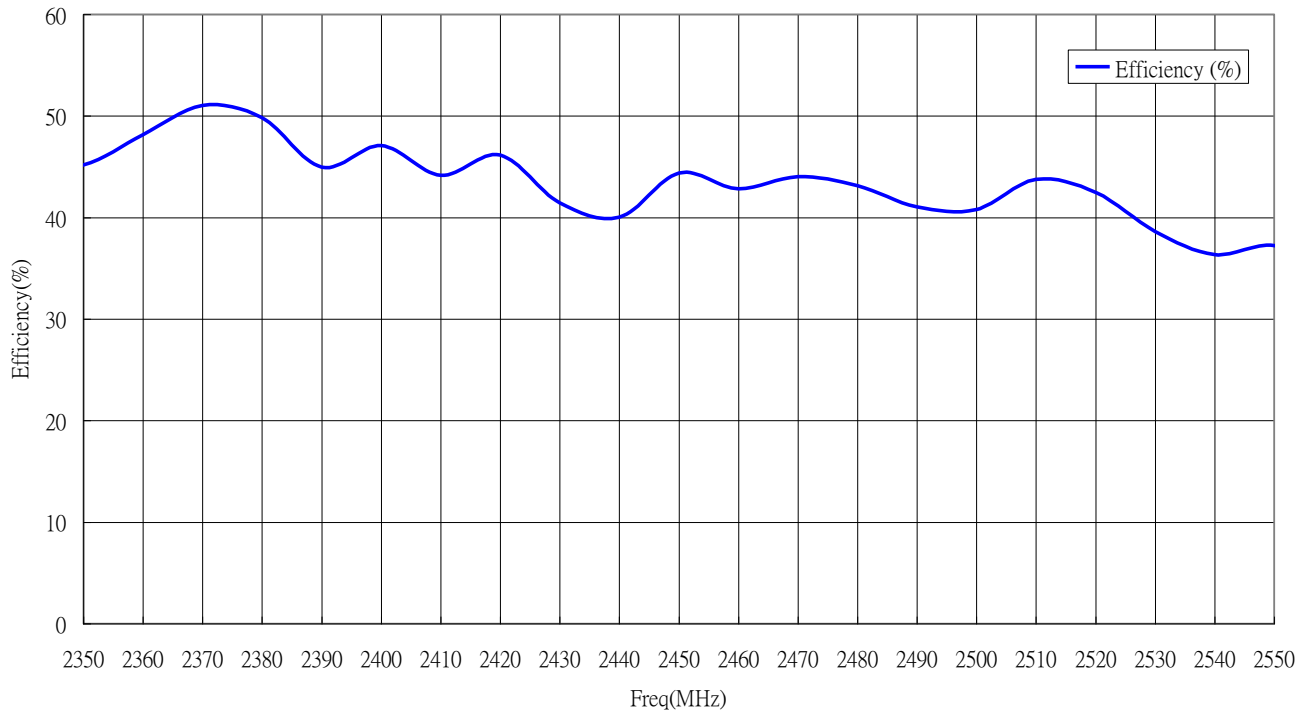

4.4 Antenna pattern (XY plane)

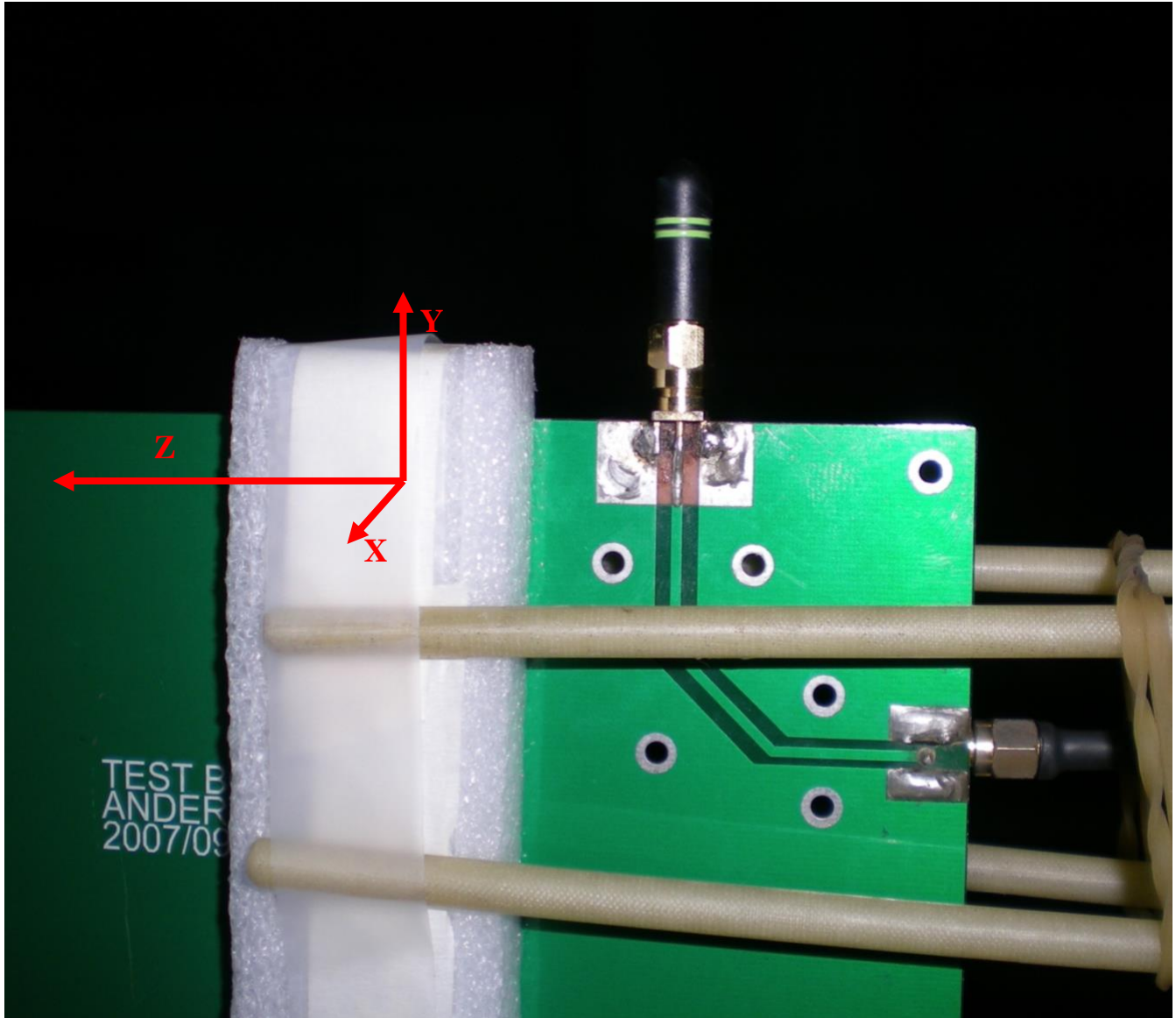

4.5 Antenna pattern (XY plane)

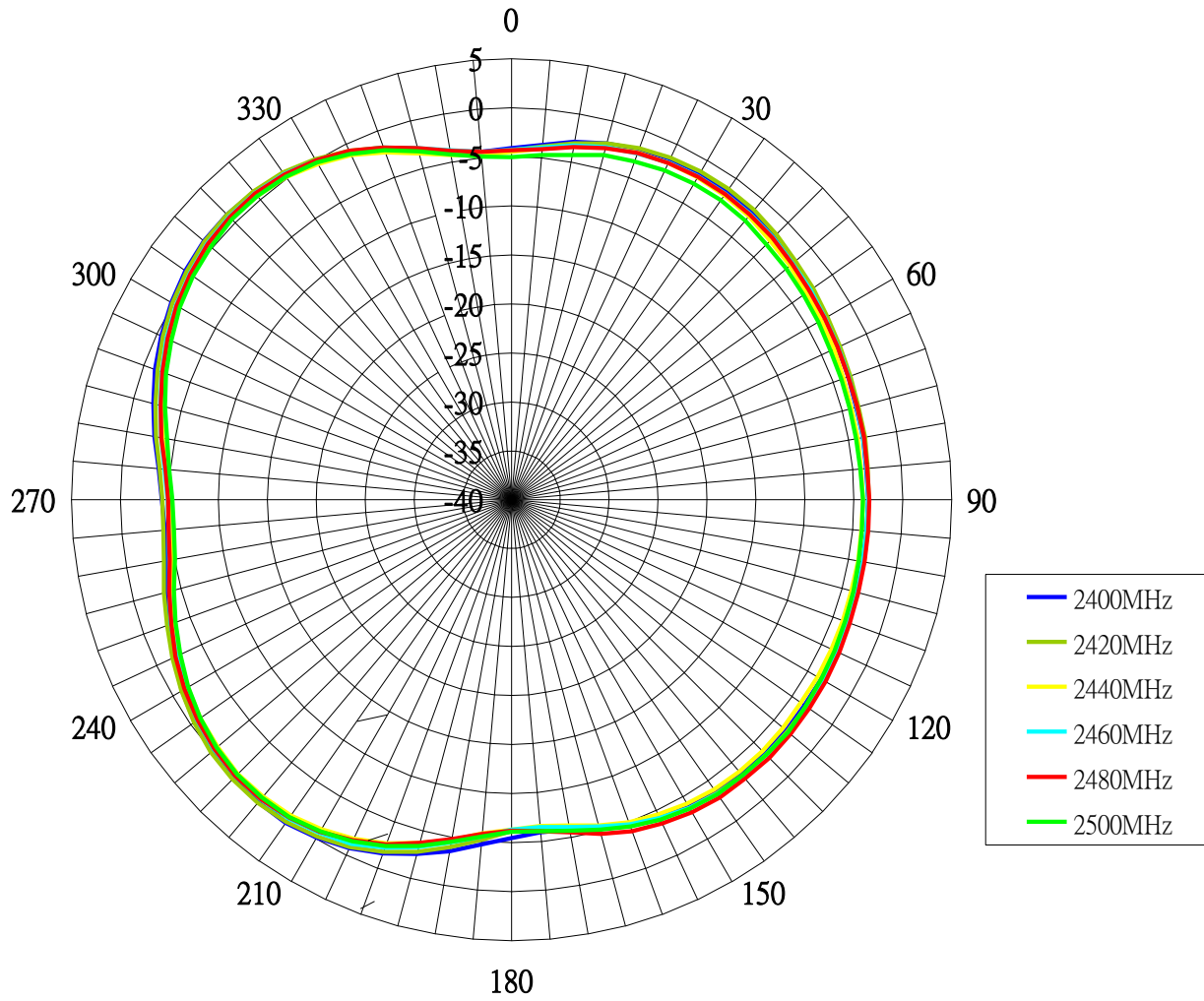

4.6 Antenna pattern (XZ plane)

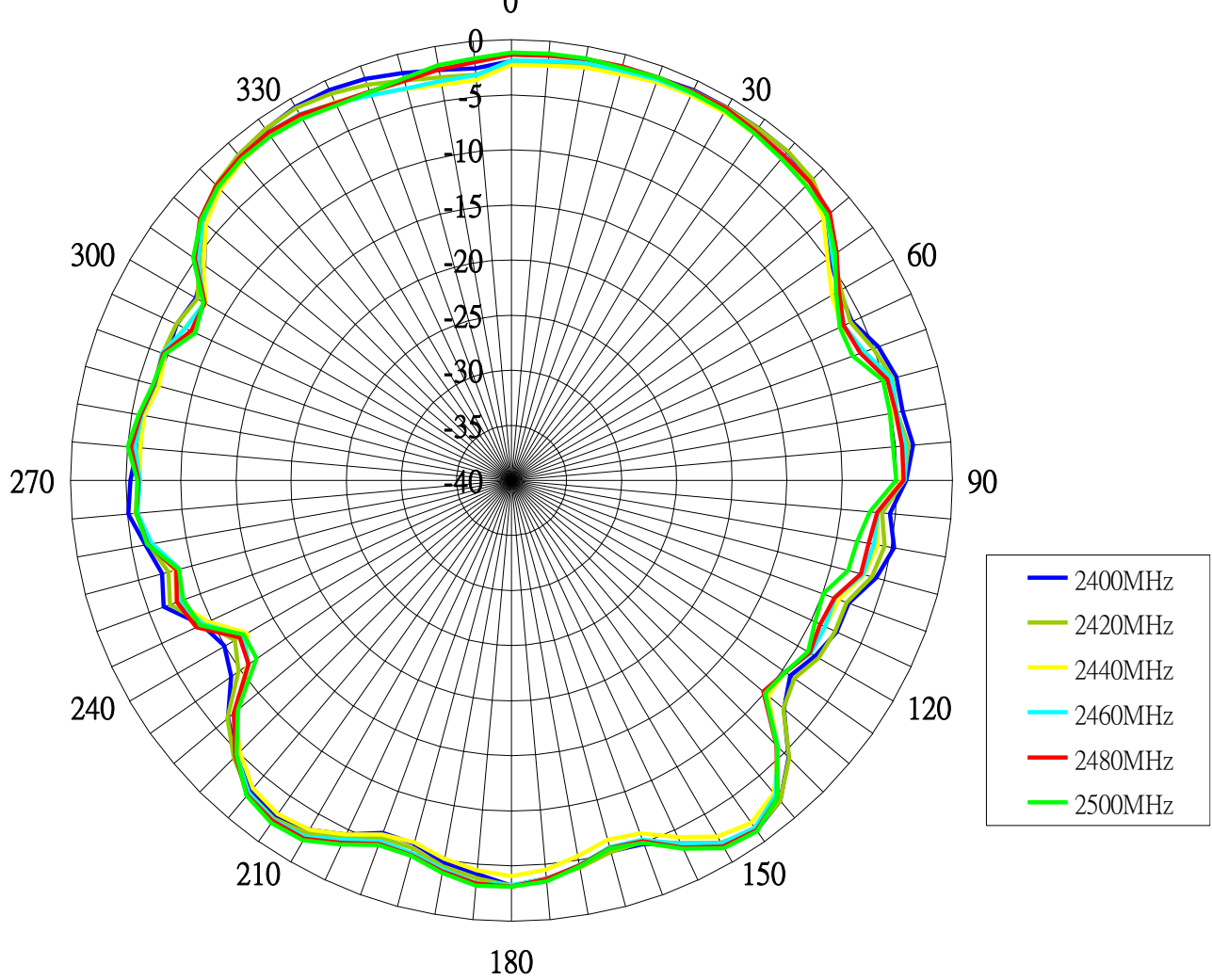

4.7 Antenna pattern (YZ plane)

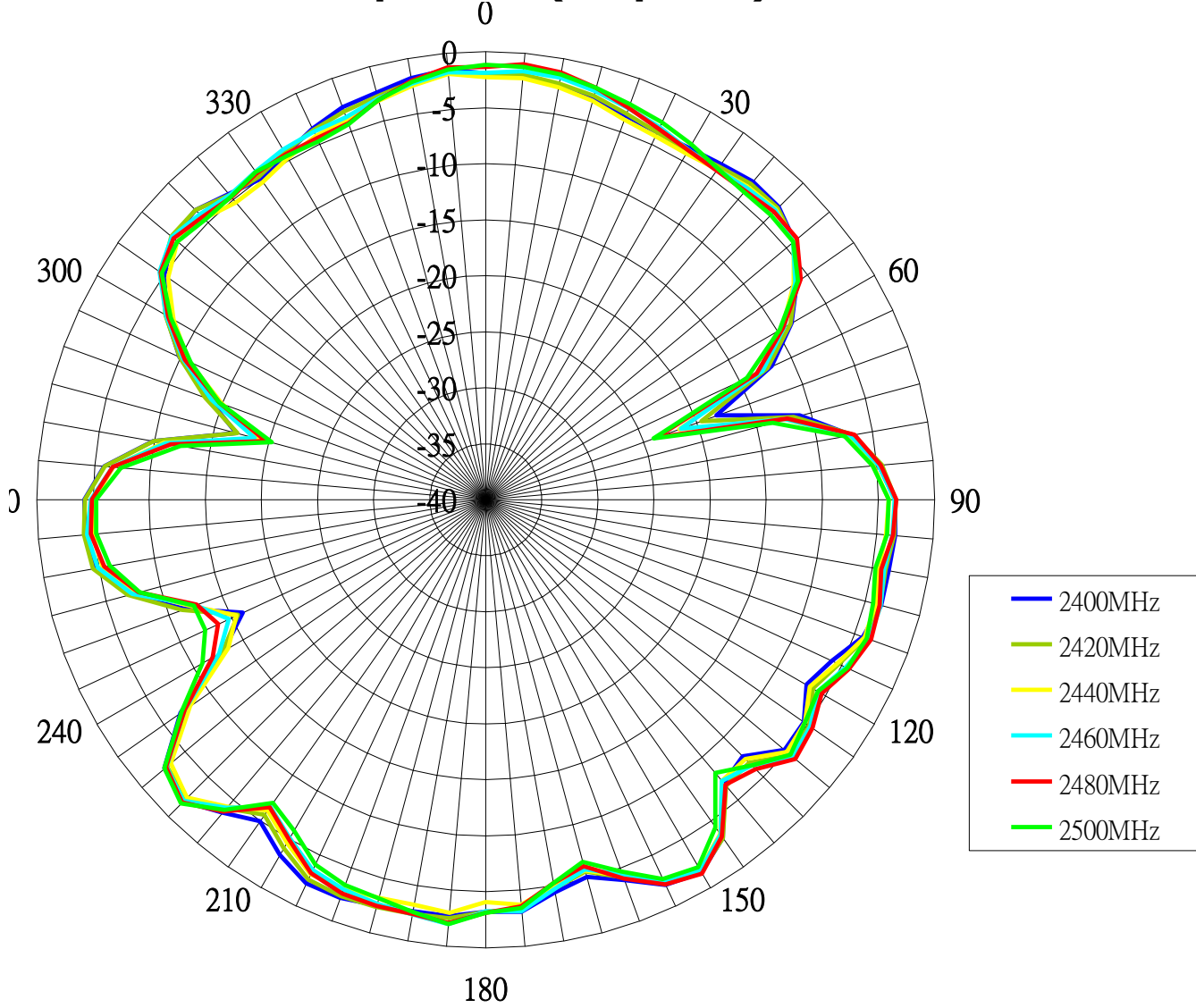

5. Outline Drawings and Structure

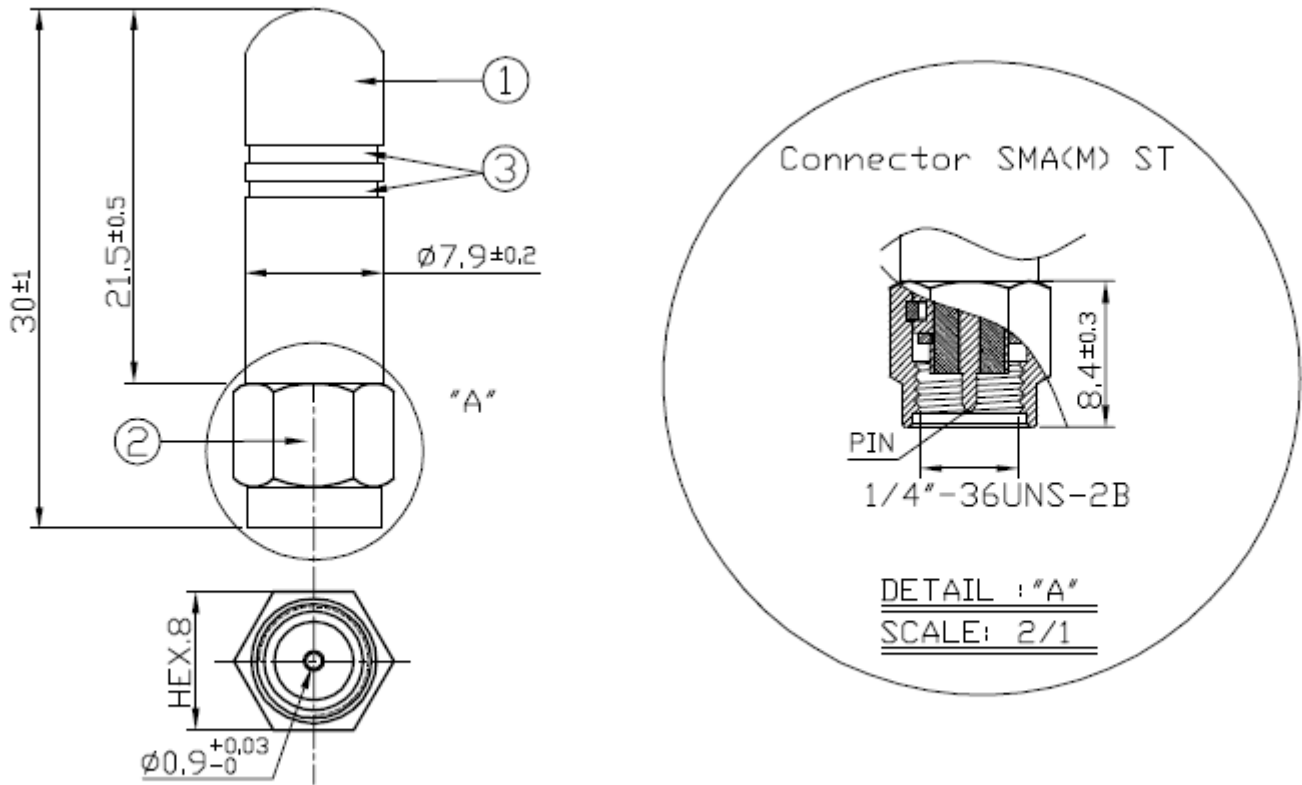

Key

1	Connector	SMA(M)ST Brass
2	Antenna Cover	TPEE (Black)
3	Colour Stripes	Apple Green – Acrylic Paint

6. Packaging

GW.26.0111 Packaging Specifications

1 pcs GW.26.0111 per PE Bag
Bag Dimensions - 74 x 42 mm
Weight - 4g

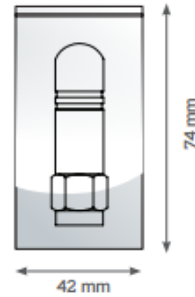

100 pcs GW.26.0111 per PE Large Bag
Bag Dimensions - 280x 180mm
Weight - 400kg

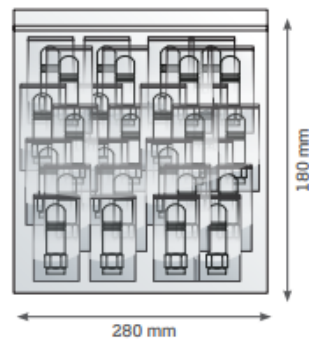

1500 pcs GW.26.0111 per carton
Carton - 360x 310 x 160mm
Weight - 6.5Kg

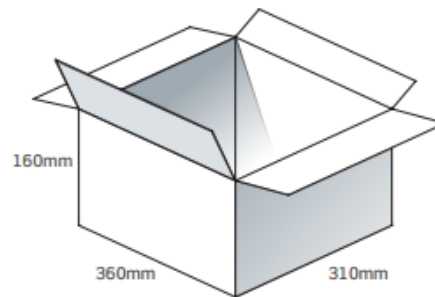

Pallet Dimensions 120x 100 x 143cm
72 Cartons per Pallet
12 Cartons per layer
6 Layers

