

Paradigm™

Health & Wellness

PLAYGROUND MIST

ITEM NO: 8901N

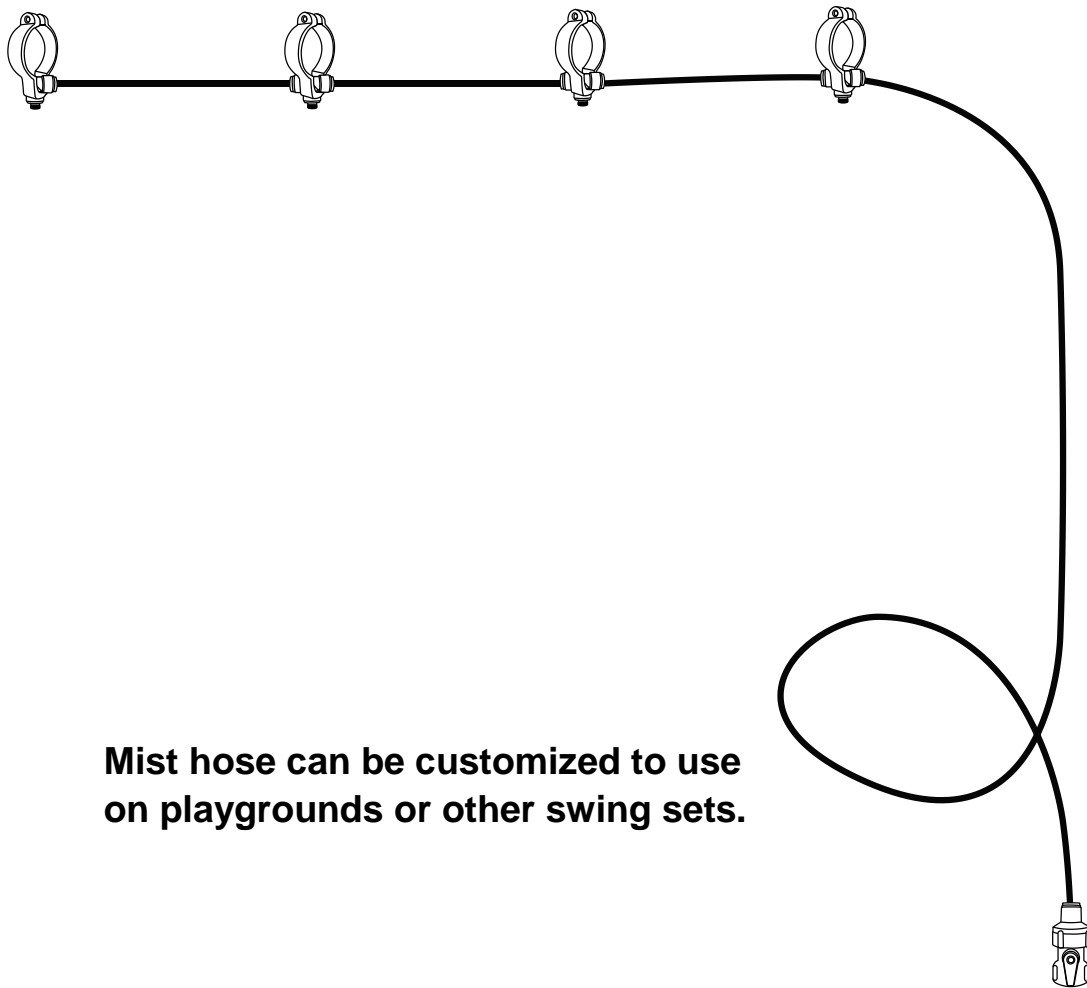

Mist hose can be customized to use on playgrounds or other swing sets.

OWNER'S MANUAL



IMPORTANT:

Read all instructions carefully before using this product. Retain this owner's manual for future reference. The specifications of this product may vary from this photo, subject to change without notice.



PLEASE DO NOT RETURN THIS PRODUCT TO THE STORE.

STOP. Contact customer service if you have any questions regarding assembly or proper operation of the machine.

Email us at:
Service@paradigmhw.com

Or call us at:
1-844-641-7920
Hours:
8:00 am to 5:00 pm (PST) Monday thru Friday

TABLE OF CONTENT

SERVICE-----	2
IMPORTANT SAFETY GUIDELINES-----	3
PARTS LIST-----	4
ASSEMBLY-----	5
WARRANTY-----	8
PARTS REQUEST FORM-----	9

SERVICE

IMPORTANT: FOR NORTH AMERICA ONLY

For damaged or defective product, questions, replacement parts or any other service support, please contact our customer service department (8:00 AM - 5:00 PM Pacific Standard Time, Monday thru Friday) by the below methods:

**For The Best Service, please Email:
service@paradigmhw.com**

Response Time: 1-2 Business Days

Emailing us with the information above will be the best method to receive a response during peak business hours

Website:

www.paradigmhw.com

Toll-Free:

1-844-641-7922

Response time may vary via calling

Refer to our email for the best response time

Please have the following information ready when requesting for service:

- Your name
- Phone number
- Model number
- Serial number
- Part number
- Proof of Purchase

For damaged or defective product please contact our customer service before returning to the store.

Paradigm Health & Wellness, Inc.

1189 Jellick Ave.

City of Industry, CA 91748, USA

IMPORTANT SAFETY GUIDELINES

Read all instructions carefully before assembling operating this product. Retain this owner's manual and keep the original purchase receipt for future reference.

1. To prevent serious injury, do not allow children to play with the Playground Mist Hose until it is completely installed.
2. Only adults should assemble or disassemble this Playground Mist Hose.
3. Teach and instruct children to NOT pull on the Playground Mist Hose when installed on the frame.
4. Warn children to NOT use the equipment without adult supervision or in any manner other than intended.
5. Do not place any part of the Playground Mist Hose near moving parts.
6. Ensure that the Playground Mist Hose is secured on the frame.
7. Do not use the Playground Mist Hose before reading manual.

⚠ CAUTION: Read all instructions carefully before operating this product.

Retain this Owner's Manual for future reference.

CARE AND MAINTENANCE

Check all bolts by monthly during the usage season for tightness and tighten as required. It is particularly important that all bolts are checked prior to the first use each season.

TOOL REQUIRED FOR ASSEMBLY

Please prepare the following tool prior to assemble this equipment.

- **Philips Screw Driver (NOT INCLUDED)**
- **Sharp Utility Knife (NOT INCLUDED)**

PARTS LIST

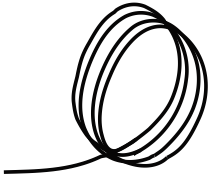
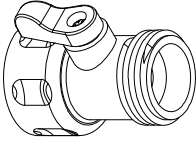
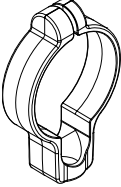
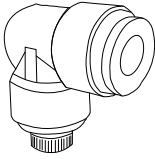
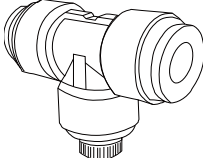
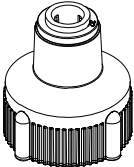
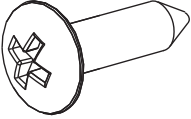
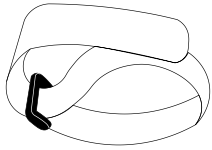
A		Tube (7.5 Meter)	1 PC
B		Hose Adaptor (Flow Control)	1 PC
C		Mist Nozzle Holder (2 Inch Diameter)	4 PCS
D		End Nozzle	1 PCS
E		Tee Nozzle	3 PCS
F		Adaptor	1 PCS
G		Screw	4 PCS
H		Velcro Strap	3 PCS

ASSEMBLY

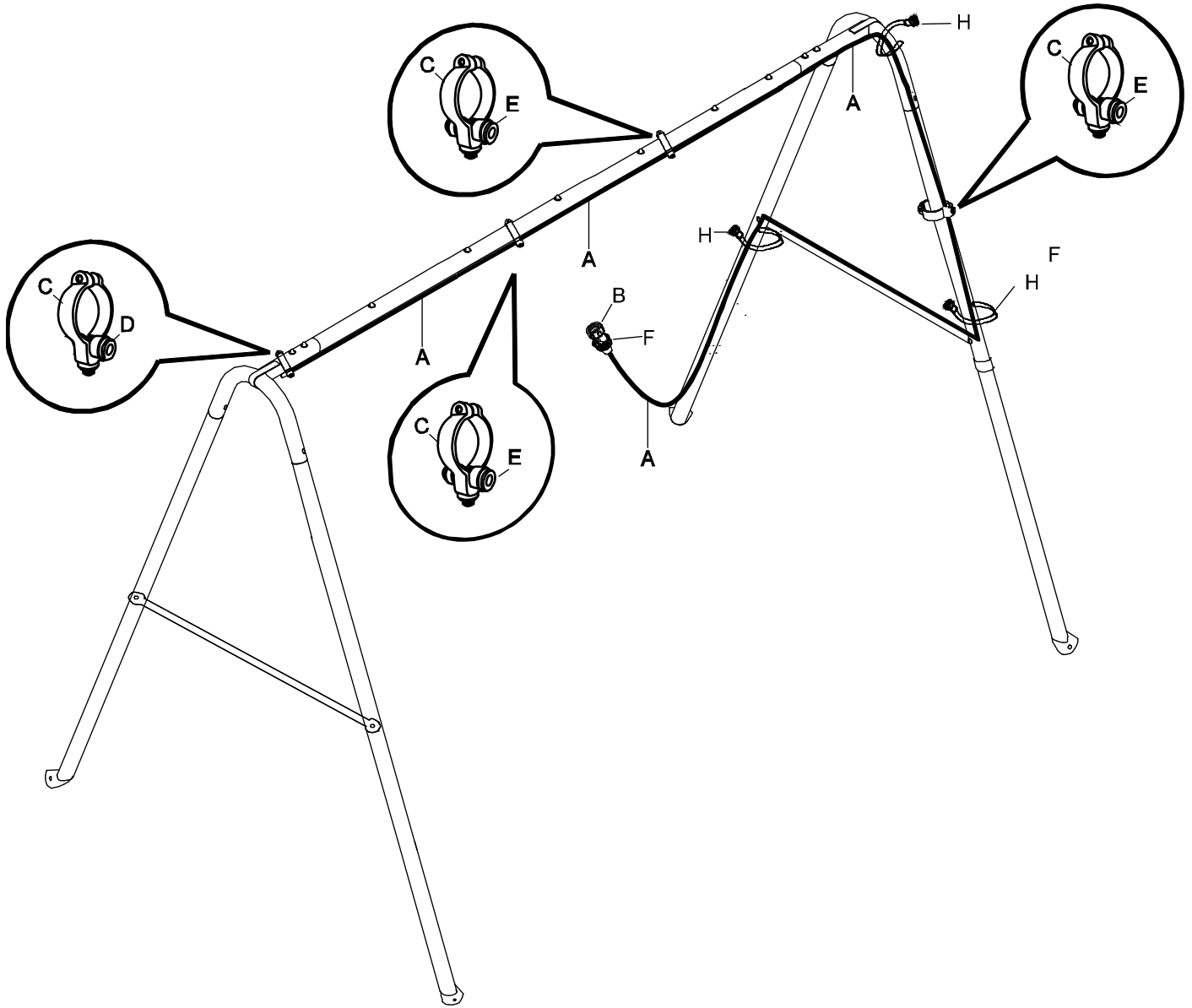

STEP 1: Planning Installation

1. Make sure no electronics or sources of electricity are near by.
2. Consider where the source of water is located to best position the **Tubing (A)** for running it up the frame. Is your hose long enough to reach the location of your playset?
3. Plan out the position for the nozzles. The image above is only one possible installation option.
4. Consider the 4 Cuts to the **Tubing (A)** you will have to make. The image above labels the four sections of the **Tubing (A)** that make up the misting system, from the **Hose Adaptor (B)** to the **End Nozzle (D)**.
 - a. **GOLDEN RULE:** Measure twice, cut once.
5. Consider your end point. The left most nozzle in the image above is the **End Nozzle (D)**. This nozzle must go at the end of the tubing system you layout.
6. Consider the nozzle positions. There are three **Tee Nozzles (E)** that allow water to flow to the connecting sections of the **Tubing (A)**.
7. Consider how to best make use of the **Velcro Straps (H)** in your tubing layout. The **Mist Nozzle Holders (C)** will hold sections of the tubing in place when install on the 2 inch frame of the playground. Use the **Velcro Straps (H)** to keep loose sections the **Tubing (A)** from hanging freely.

ASSEMBLY

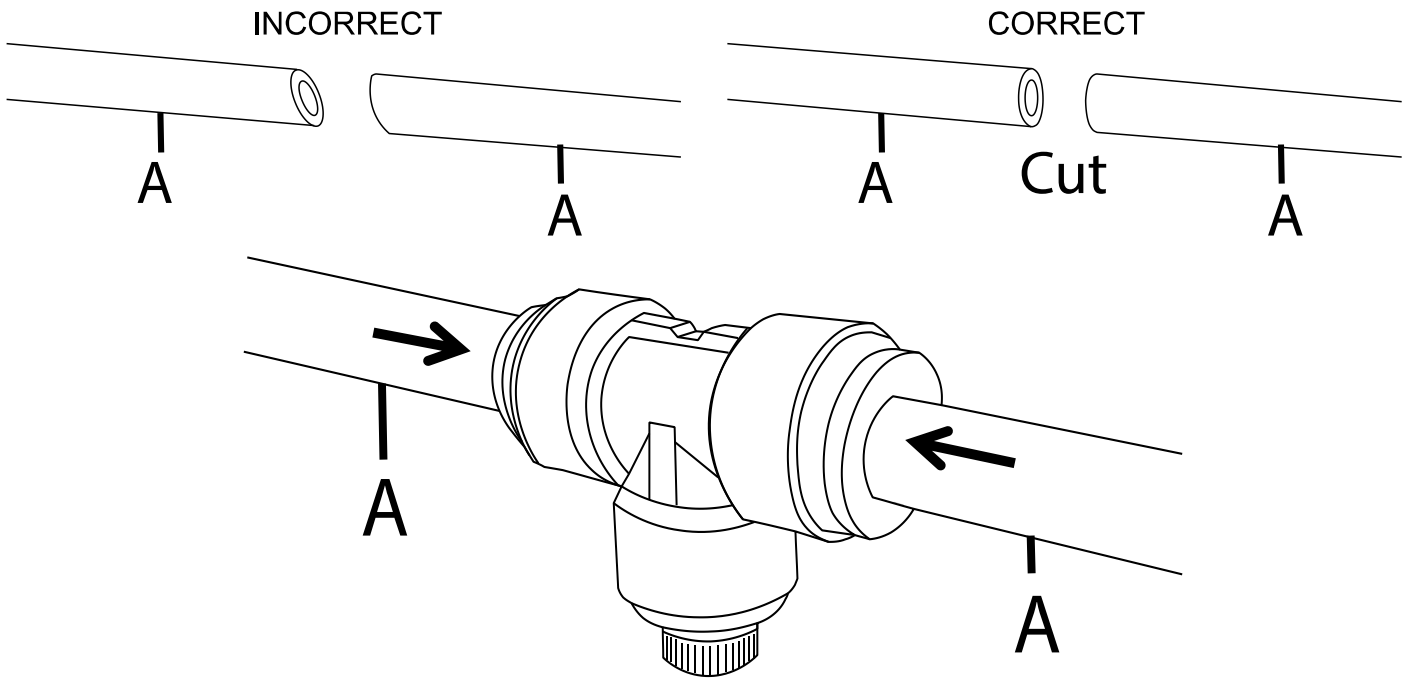

STEP 2: Inserting the Tubing

1. Cut the lengths of tubing needed to connect the nozzles placed at your desired locations.
2. Firmly insert the ends of the **Tubing (A)** into the three **Tee Nozzles (E)** and one **End Nozzle (D)**.

NOTE: Make the the section of **Tubing (A)** being inserted have a clean and flat 90 degree cut. If leaks occur at the connection points, remove the tubing and recut the end to improve the seal.

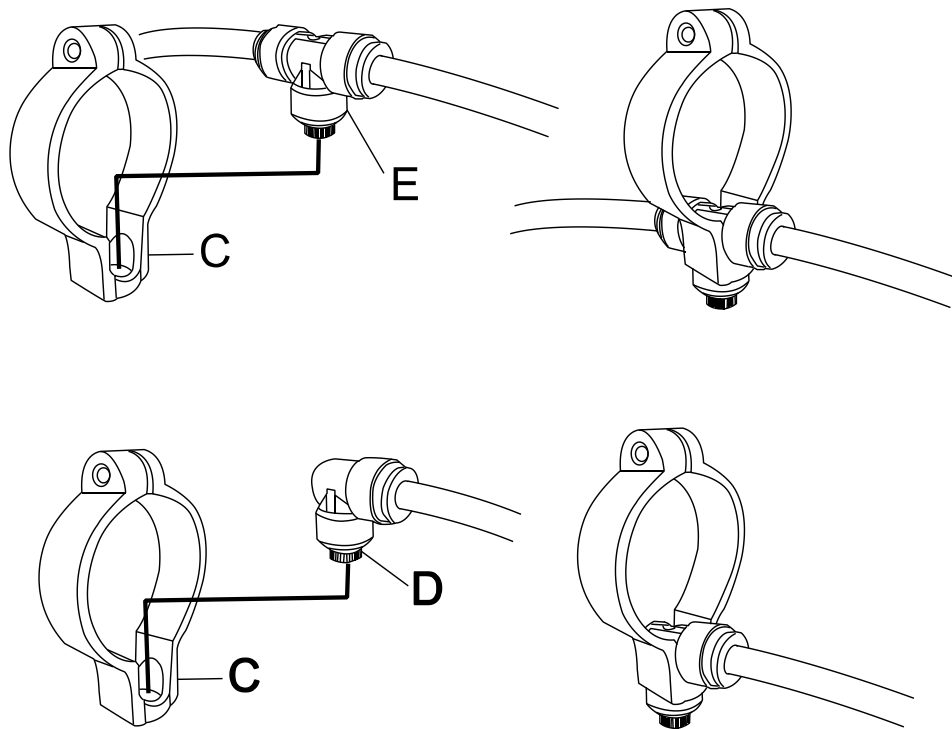

STEP 3: Assembling the Nozzles

1. Insert the three **Tee Nozzles (E)** into three **Mist Nozzle Holders (C)**.
2. Insert the one **End Nozzles (D)** into one **Mist Nozzle Holdes (C)**.

ASSEMBLY

Hardware:

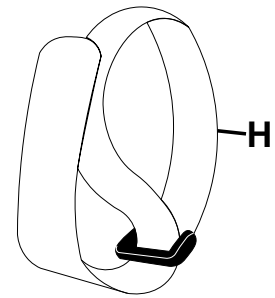
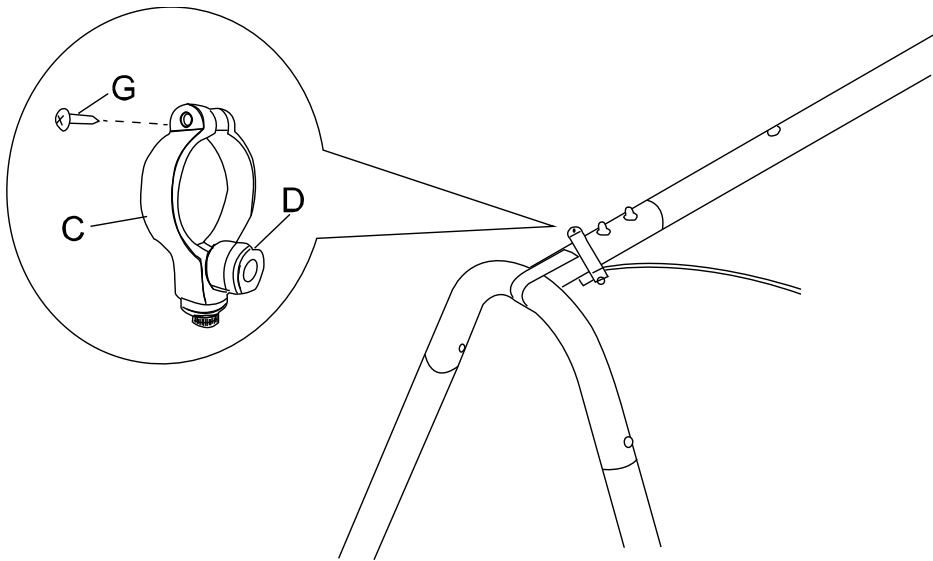

(H) Velcro Strap 3PCS

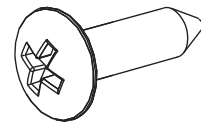

(G) Screw 4PCS

STEP 4: Attaching the Nozzles to the Frame

1. Spread the **Mist Nozzle Holders (C)** to wrap it around the 2 inch **Swing Set** frame tubing.
2. Use one **Screw (G)** to attach the **Mist Nozzle Holders (C)** to the frame. Thoroughly tighten the **Screw (G)** with a **Phillips Screwdriver**.
3. Repeat this for the three other **Mist Nozzle Holders (C)**.
4. Use the **Velcro Straps (H)** to support any **Tubing (A)** that is hanging loosely or to help guide the **Tubing (A)** at a bend in the **Swing Set** frame.

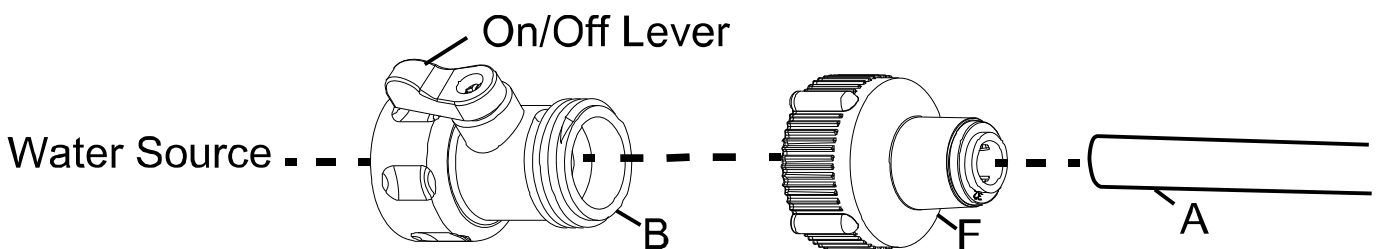

STEP 5: Connecting the Adaptors

1. Attach the **Hose Adaptor (B)** to the **Water source**.
2. Firmly insert the first end of the **Tubing (A)** into the **Adaptor (F)**.
3. Attach **Adaptor (F)** to the **Hose Adaptor (B)**.

NOTE: Make the the section of **Tubing (A)** being inserted has a clean and flat 90 degree cut. If leaks occur at the connection points, remove the tubing and recut the end to improve the seal.

WARRANTY

MANUFACTURER'S LIMITED WARRANTY

Paradigm Health & Wellness warrants to the original purchaser that this product is free from defects in material and workmanship when used for the purpose intended, under the conditions that it has been installed and operated in accordance with Paradigm's Owner's Manual. Paradigm's obligation under this warranty applies to the following:

<u>COMPONENT</u>	<u>LENGTH OF WARRANTY</u>
All Components	1 year For Home Use Only

(console display, electronics, upholstery, foam, ball bearings, pulleys, belts, cables, wires, shocks, covers, tension, internal mechanism, wheels, pedals, knobs, accessories and hardware)

Exclusions from Warranty Coverage:

Paradigm does not warrant against and is not responsible for, and no implied warranty shall be deemed to cover, any product failure, product malfunction, or damages attributable to:

1. Improper installation and/or failure to abide by Paradigm's installation guidelines;
2. Use of this product beyond normal home use, or in an application for which it was not designed;
3. Cosmetic items such as scratches, dents or discolorations;
4. Damage caused by normal wear and tear, vandalism, accidental, and by animals;
5. Any act of Nature (such as fire, flooding, snow, ice, hurricane, earthquake, lightning or other natural disaster), environmental condition (such as air pollution, mold, mildew, etc.), or staining from foreign substances (such as dirt, grease, oil, etc.);
6. Normal weathering due to exposure to sunlight, weather and atmosphere which can cause colored surfaces to, among other things, flake, chalk, accumulate dirt or stains.
7. Improper operation, alteration, handling, storage, abuse or neglect of the products.

Paradigm, using its sole discretion, will either repair or replace free of charge any part(s) proven to be defective under normal home use. Any repair or replacement shall provide no new warranty coverage, but shall retain only the remaining portion of the original product's warranty. This warranty is offered only to the original purchaser and is not transferable.

Proof of original purchase is required.

Ordering Replacement Parts

Replacement parts can be ordered by emailing our customer service department:

Service@paradigmhw.com

Open Monday thru Friday 8:00 AM - 5:00 PM (PST).

When ordering replacement parts please have the following information ready:

1. **Owner's Manual**
2. **Model Number**
3. **Description of Parts**
4. **Part Number**
5. **Date of Purchase**

