

SINCE 1889



Plasma Reactor

Model

PR300

Instruction Manual

- First Edition -

- Thank you for purchasing " Plasma Reactor, PR 300" of Yamato Scientific Co., Ltd.
- To use this unit properly, read this "Instruction Manual" thoroughly before using this unit.
Keep this instruction manual around this unit for referring at anytime.



WARNING!:

Carefully read and thoroughly understand the important warning items described in this manual before using this unit.

Yamato Scientific Co. LTD.

Contents

◆ Cautions in Using with Safety	1
• Explanation.....	1
• Table of Illustrated Symbols	2
• Fundamental Matters of “WARNING!” and “CAUTION!”	3
◆ Before Using this unit	4
• Requirements for Installation.....	4
• Requirements for Installation.....	6
◆ Description and Function of Each Part	7
• Main Unit	7
• Control Panel.....	8
◆ Installation Method	9
• Cable tube connection.....	9
• Principle of operation.....	10
• Preparation for operation.....	11
◆ Operation Method	12
• Operation Procedure	12
◆ Handling Precautions	17
◆ Maintenance Method	19
• Daily Inspection and Maintenance	19
◆ Long storage and disposal	20
• When not using this unit for long term / When disposing	20
◆ In the Event of Failure	21
◆ After Service and Warranty	22
◆ Specification	23
◆ Wiring Diagram	24
◆ Replacement Parts Table	25
◆ Reference	26
• List of Dangerous Substances	26

Explanation

MEANING OF ILLUSTRATED SYMBOLS

Illustrated Symbols

Various symbols are used in this safety manual in order to use the unit without danger of injury and damage of the unit. A list of problems caused by ignoring the warnings and improper handling is divided as shown below. Be sure that you understand the warnings and cautions in this manual before operating the unit.

 **WARNING!** If the warning is ignored, there is the danger of a problem that may cause a serious accident or even fatality.

 **CAUTION!** If the caution is ignored, there is the danger of a problem that may cause injury/damage to property or the unit itself.

Meaning of Symbols



This symbol indicates items that urge the warning (including the caution). A detailed warning message is shown adjacent to the symbol.



This symbol indicates items that are strictly prohibited. A detailed message is shown adjacent to the symbol with specific actions not to perform.



This symbol indicates items that should be always performed. A detailed message with instructions is shown adjacent to the symbol.

Cautions in Using with Safety

Table of Illustrated Symbols

Warning



Warning,
generally



Warning,
high voltage



Warning,
high temperature



Warning,
drive train



Warning,
explosive

Caution



Caution,
generally



Caution,
electrical shock



Caution,
scald



Caution,
no road heating



Caution,
not to drench



Caution,
water only



Caution,
deadly poison

Prohibit



Prohibit,
generally



Prohibit,
inflammable



Prohibit,
to disassemble



Prohibit,
to touch

Compulsion



Compulsion,
generally



Compulsion,
connect to the
grounding
terminal



Compulsion,
install on a flat
surface



Compulsion,
disconnect the
power plug



Compulsion,
periodical
inspection

Cautions in Using with Safety

Fundamental Matters of “WARNING!” and “CAUTION!”

WARNING!

Do not use this unit in an area where there is flammable or explosive gas

Never use this unit in an area where there is flammable or explosive gas. This unit is not explosion-proof. An arc may be generated when the power switch is turned on or off, and fire/explosion may result. (Refer to page26 “List of Dangerous Substances”.)

Always ground this unit

Always ground this unit on the power equipment side in order to avoid electrical shock due to a power surge.

If a problem occurs

If smoke or strange odor should come out of this unit for some reason, turn off the power key right away, and then turn off the breaker and the main power. Immediately contact a service technician for inspection. If this procedure is not followed, fire or electrical shock may result. Never perform repair work yourself, since it is dangerous and not recommended.

Do not use the power cord if it is bundled or tangled

Do not use the power cord if it is bundled or tangled. If it is used in this manner, it can overheat and fire may be caused.

Do not process, bend, wring, or stretch the power cord forcibly

Do not process, bend, wring, or stretch the power cord forcibly. Fire or electrical shock may result.

Substances that can not be used

Never use explosive substances, flammable substances and substances that include explosive or flammable ingredients in this unit. Explosion or fire may occur.

Do not disassemble or modify this unit

Do not disassemble or modify this unit. Fire or electrical shock or failure may be caused.

CAUTION!

During a thunder storm

During a thunderstorm, turn off the power key immediately, then turn off the breaker and the main power. If this procedure is not followed, fire or electrical shock may be caused.

Requirements for Installation

WARNING!

1. Always ground this unit



- Connect the power plug to a receptacle with grounding connectors.



- Do not forget to ground this unit, to protect you and the unit from electrical shock in case of power surge. Choose a receptacle with grounding connectors as often as possible.
- Do not connect the grounding wire to a gas pipe, or by means of a lightning rod or telephone line. A fire or electrical shock will occur.

2. Choose a proper place for installation



- Do not install this unit in a place where:
 - ◆ Rough or dirty surface.
 - ◆ Flammable gas or corrosive gas is generated.
 - ◆ Ambient temperature exceeds 35°C.
 - ◆ Ambient temperature fluctuates violently.
 - ◆ There is direct sunlight.
 - ◆ There is excessive humidity and dust.
 - ◆ There is a constant vibration.



- Install this unit on a stable place with the space as shown below.

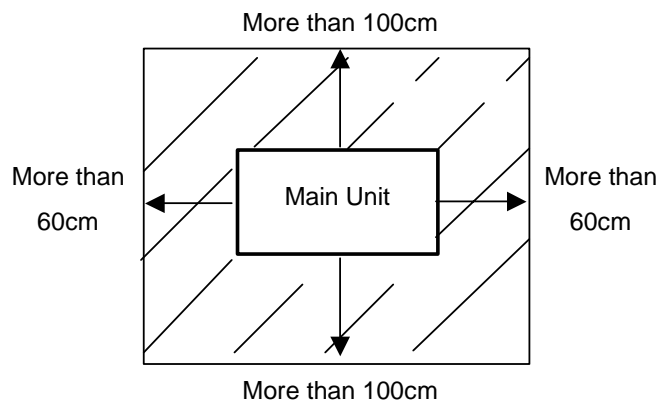

3. Do not use this unit in an area where there is flammable or explosive gas



- Never use this unit in an area where there is flammable or explosive gas. This unit is not explosion-proof. An arc may be generated when the power switch is turned ON or OFF, and fire/explosion may result.

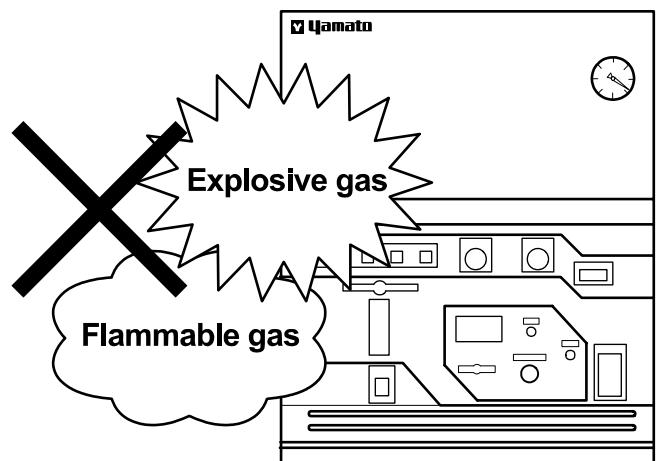

Requirements for Installation

4. Do not modify



- Modification of this unit is strictly prohibited. This could cause a failure.

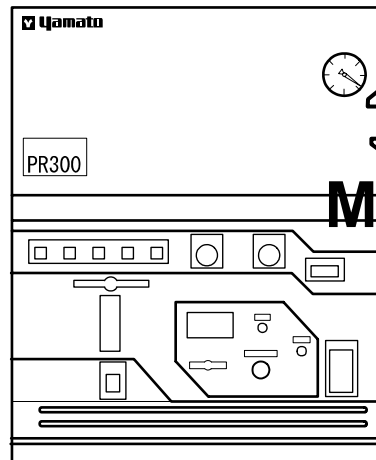

5. Installation on horizontal surface



- Set this unit to the flattest place. Setting this unit on rough or slope place could cause the vibration or noise, or cause the unexpected trouble or malfunction.

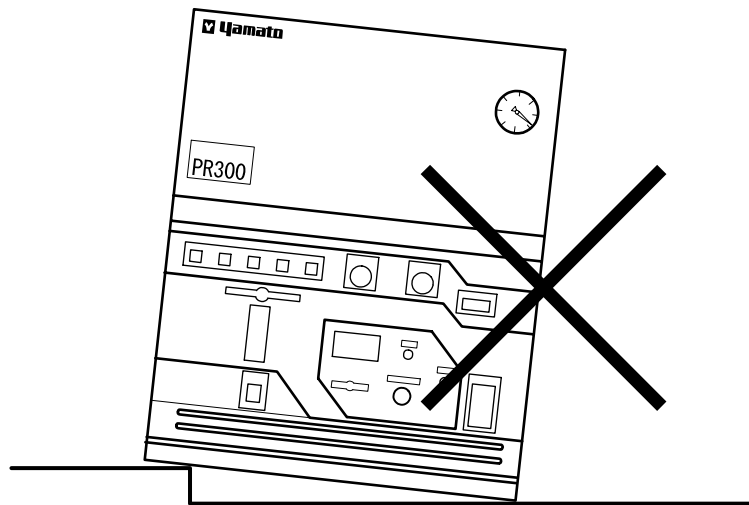

Requirements for Installation

CAUTION!

6. Choose a correct power distribution board or receptacle



- Choose a correct power distribution board or receptacle that meets the unit's rated electric capacity.

Electric capacity: 100V AC, 10A

NOTE)

There could be the case that the unit does not run even after turning ON the power. Inspect whether the voltage of the main power is lowered than the specified value, or whether other device(s) uses the same power line of this unit. If the phenomena might be found, change the power line of this unit to the other power line.

7. Before/after installing



- It may cause injure to a person if this unit falls down or moves by the earthquake and the impact. etc..To prevent, take measures that the unit cannot fall down, and not install to busy place.
- Touching the unit may cause a burn during and just after the operation. To prevent, take measures that putting up a notice of operating etc..

8. Connection to vacuum pump



- Use the vacuum pump with the displacement of 160 ℓ / min .

Description and Function of Each Part

Main Unit

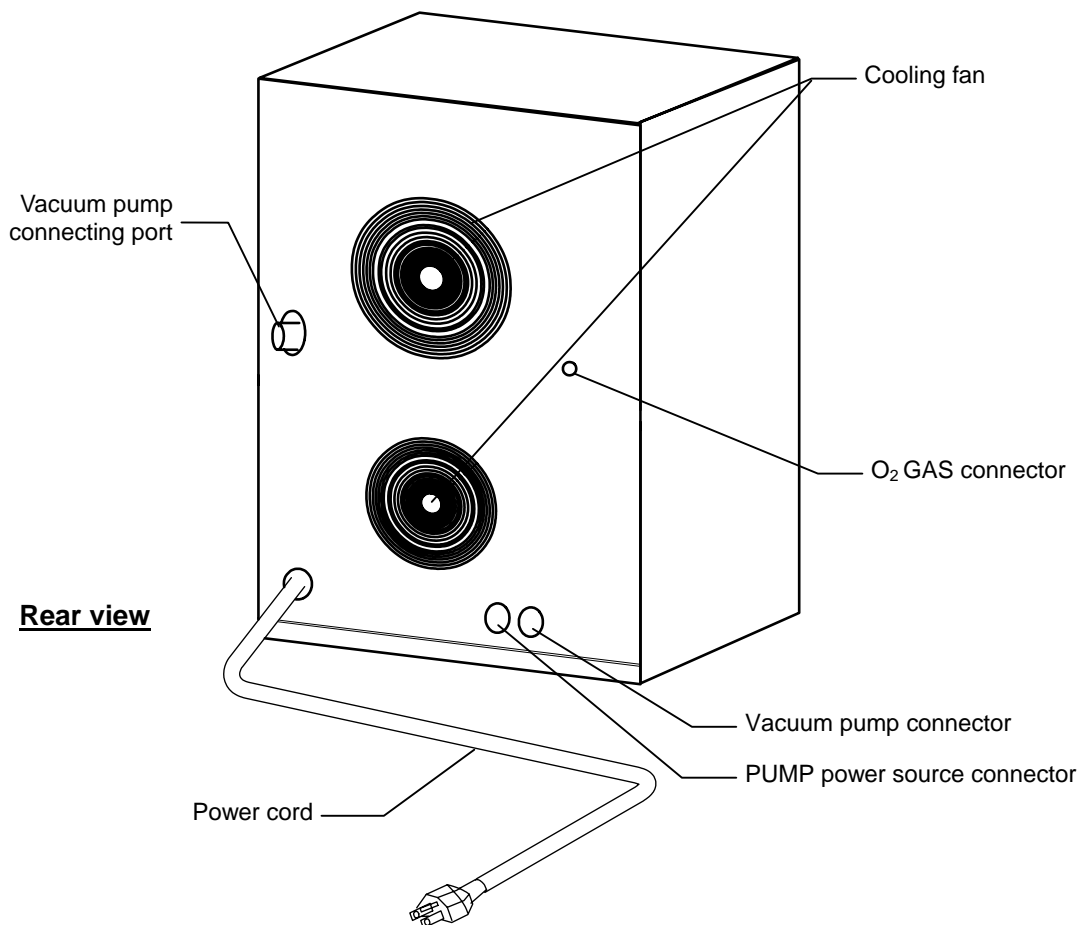
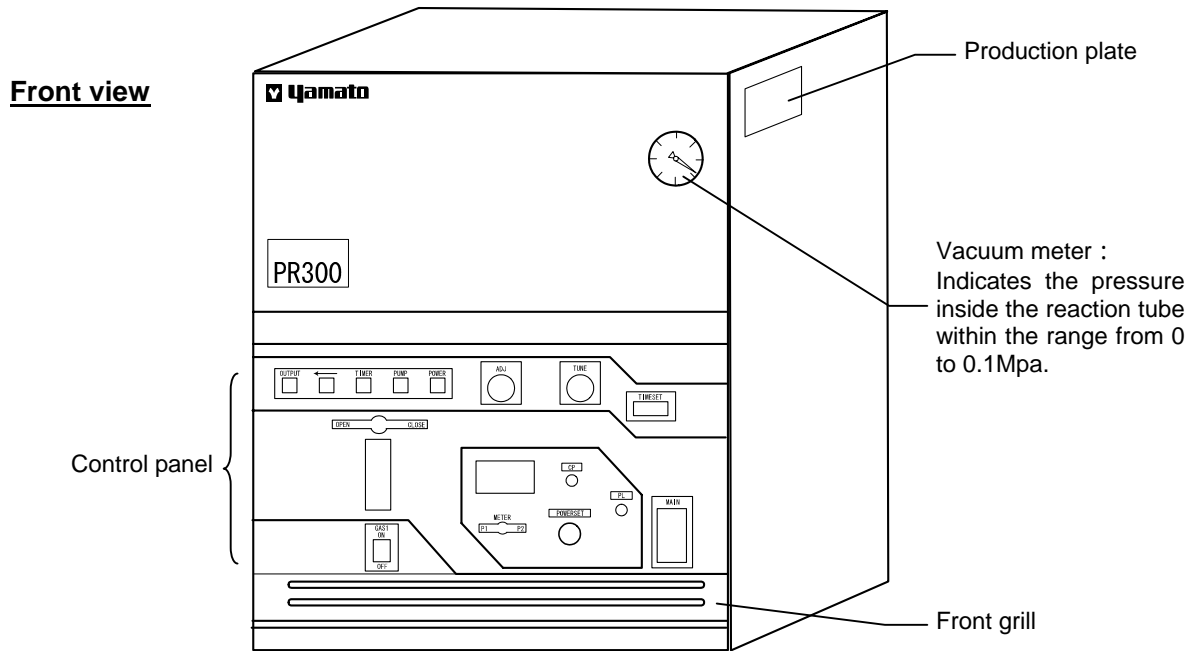

Description and Function of Each Part

Control Panel

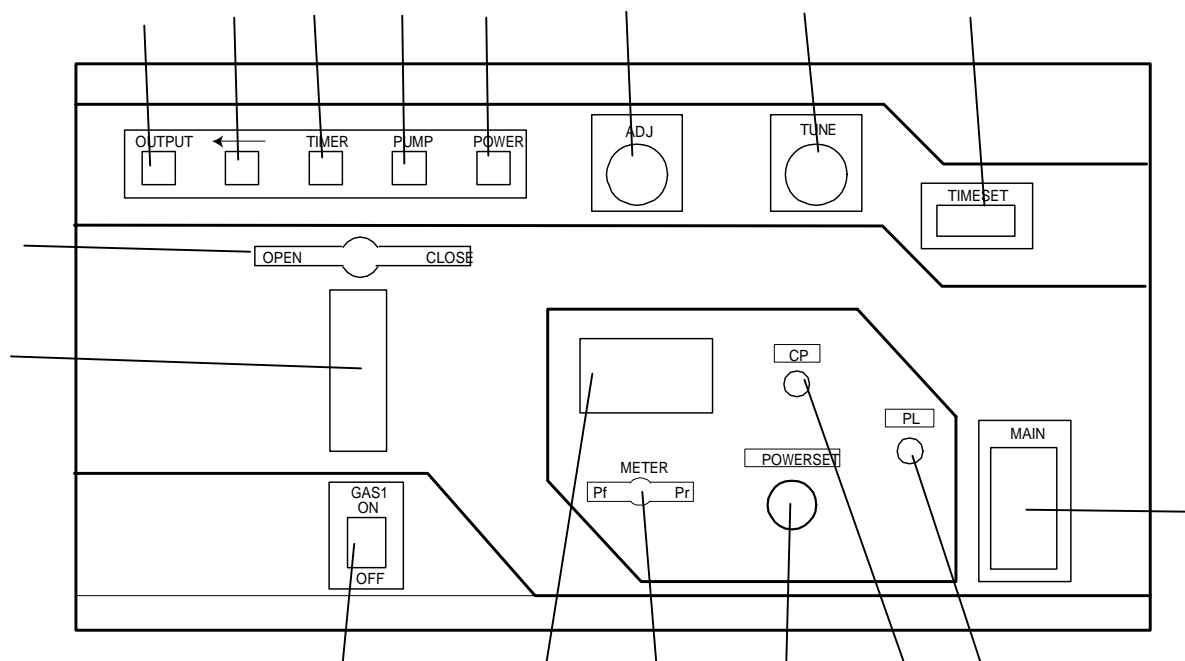

Main Switch:	Switches the main power supply and functions as a circuit protector, too. When over current is detected, it turns off the power supply.
Power Switch:	Starts to operate cooling fan when it is turned on. The lamps light on. The solenoid valve for leak is also turned on.
Pump Switch:	The switch to drive the vacuum pump. The pump starts to operate when this switch is turned on. At the same time the solenoid valve for leak is turned off. The lamp lights on.
Timer Switch:	Used to apply high-frequency power for definite period of time. Normally turn the switch to OFF.
Ready Lamp:	Lights on after three minute has passed since the pump switch ON. The output switch is possible to be set to ON after the lamp lights on.
Output Switch:	ON/OFF switch for high-frequency power.
Gas Valve 2 (O₂) switch:	ON/OFF switch for solenoid valve for supplying O ₂ gas.
Flow Meter (O₂):	Indicates the flow rate of O ₂ gas inside the reaction tune.
Needle Valve Knob (O₂):	Adjusts the flow rate of gas that is taken into the reaction tube while monitoring above.
CP (constant power) Lamp:	Lights on when the reflected power is large (around seven watts).
PL Lamp	Lights on when the main switch is turned to ON.
Output/Reflected Power Meter:	Indicates the output power (0 to 300W).
Meter Selector Switch:	Selects output power/reflected power display in .
Output Control Knob:	Controls the output power within the range from 0 to 300 watts.
TUNE Knob:	Tunes output and load (reaction tube) to minimize the reflected power.
ADJ Knob:	Tunes output and load (reaction tube) to minimize the reflected power.
Timer:	Sets the timer of high frequency applying period.

Cable tube connection

- Connect the cable tube according to the right figure.
- Refer to the connection of vacuum pump and gas piping for the page 11.
- ❖ The parts enclosed with the dotted line indicate optional accessories.

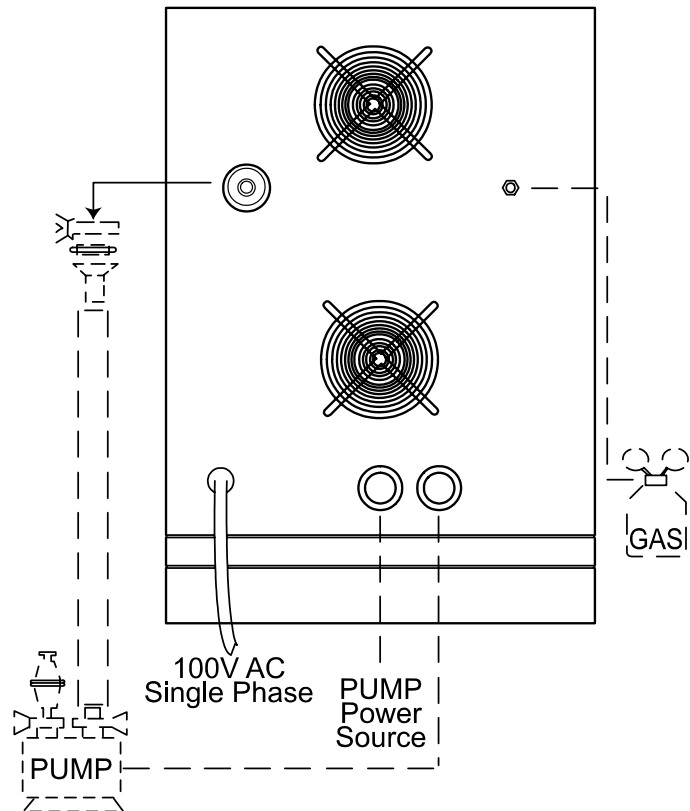

Piping System View

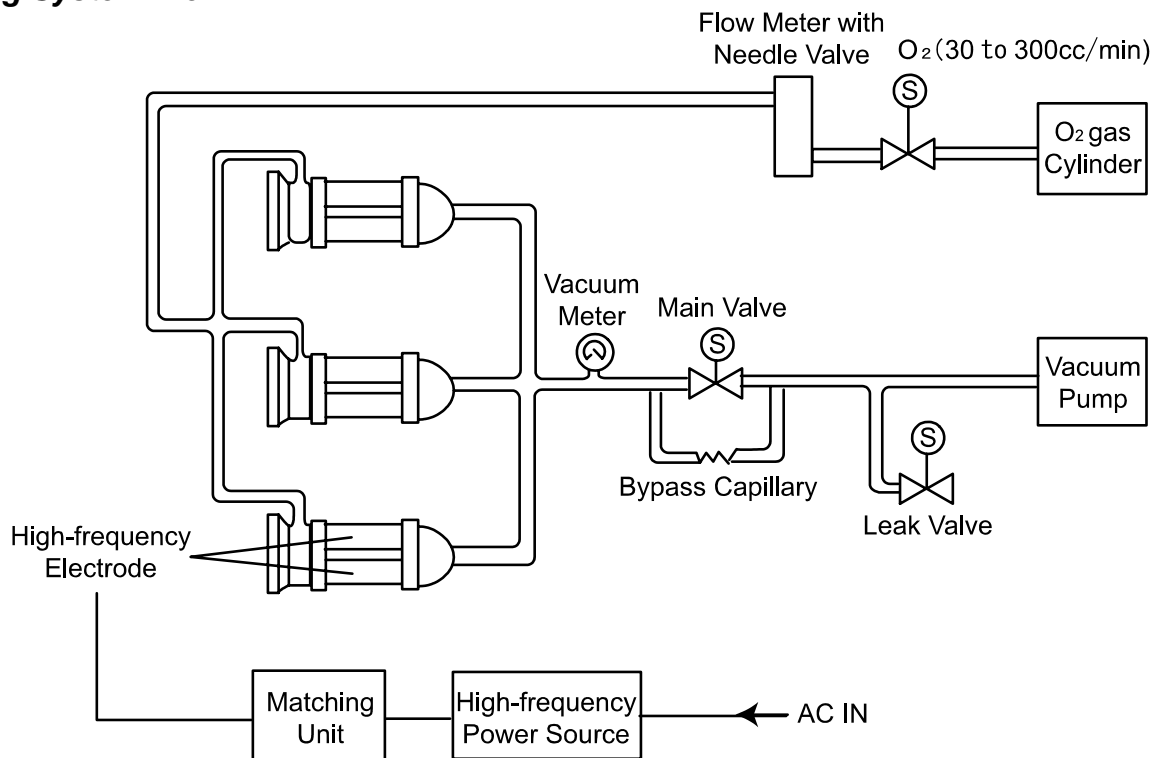

Principle of operation

(Refer to the operation flow chart below.)

- The controller supplies the high-frequency power of 13.56MHz generated by crystal oscillation to the reaction section. The output range is from 0 to 300W that can be set to desired value with the wattmeter attached.
- O₂ (30 ~ 300m ℓ /min) can be supplied to the reaction tube with the flow meter. The flow rate can be set to desired value.
- The gas is changed into plasma by high-frequency energy applied to the high-frequency supplying electrode.
- The gas exhaust is carried out through the main valve on vacuum meter, bypass, and leak valve. Turning the pump switch to ON starts pressure reduction through the bypass. After around 1 minutes, the main valve opens to increase the reduction speed. Turning the pump to OFF closes the main valve and opens the leak valve. The pressure in the reaction tube is intensified to normal pressure.
- In the high-frequency circuit without impedance matching, the reflected power generates, which may lead loss of electric power. Impedance matching is necessary to apply electric power to the reaction tube effectively.
- The matching unit consists of a coil and a variable capacitor, where the impedance matching is carried out inside the reaction tube and at high-frequency power source. Turn the control knob observing the output/reflected power meter at the controller. Then apply electric power with the TUNE and ADJ knobs to minimize the reflected power.

Operation flow chart

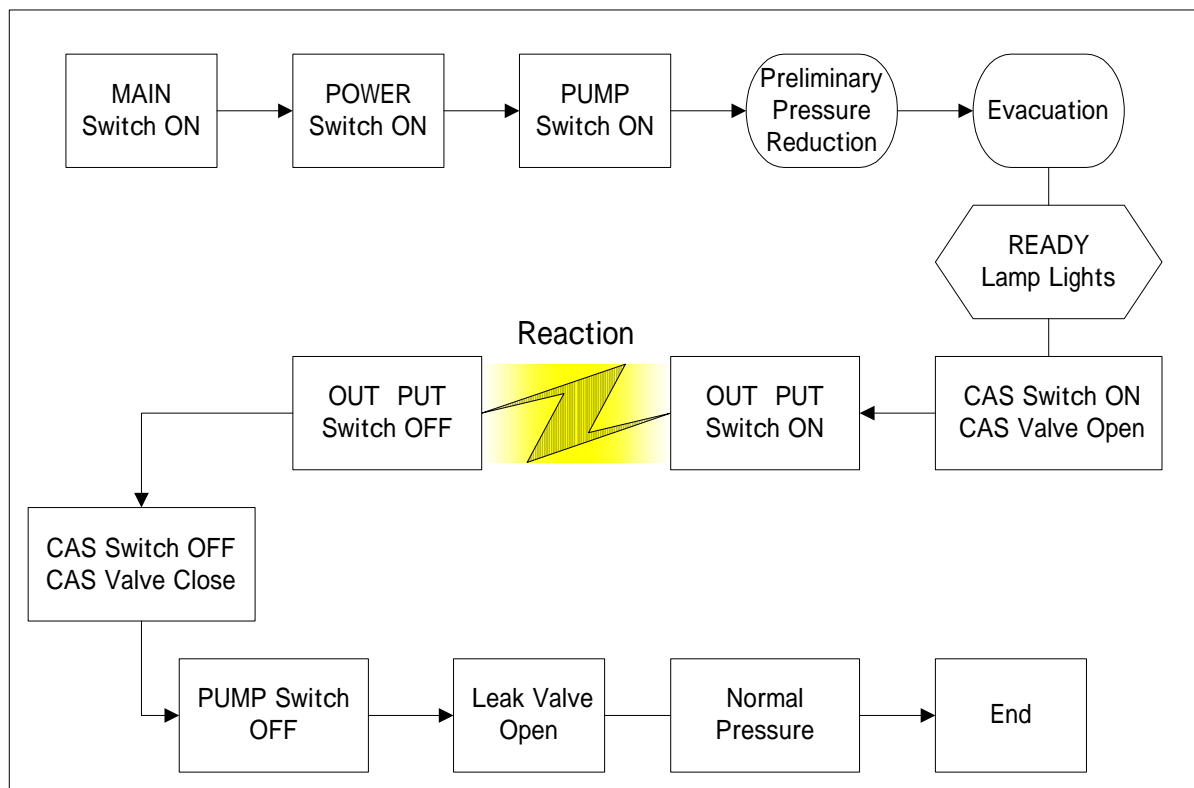

Preparation for operation

Connection to vacuum pump

- Use the vacuum pump with the displacement of 160 ℓ /min (5A or below).
- A NW 25 flange type is used to connect the unit and vacuum pump. In case a vacuum hose is used for connection, a rubber tube adapter, center ring and clamp are needed.
- Using an oil mist eliminator, such as a trap, at the exhaust opening of vacuum pump eliminates smoke. Note that the distance between the eliminator and pump should be 0.5 to 1 meter, and that exhaust gas should be exhausted outside room (hoses are not attached.)
- Relays for pump are inside the unit. Wire connect to the metal connector attached referring to the figure below for the connection to pump

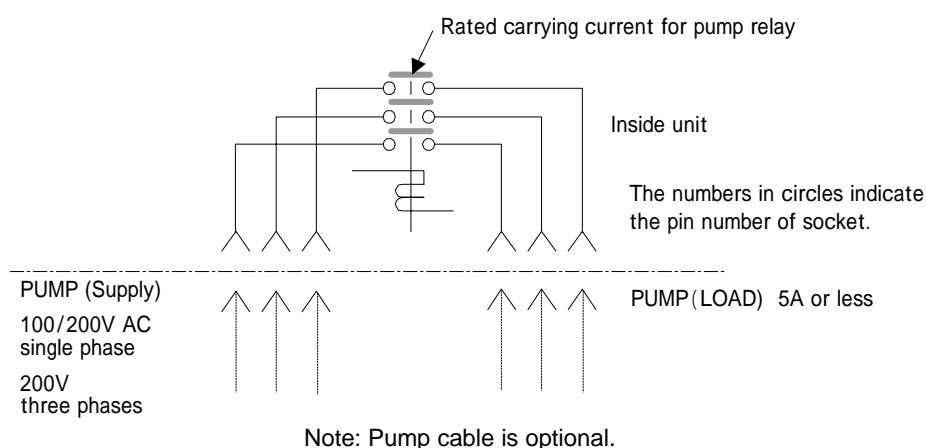

Gas piping

- The gas inlet uses 1/4" swage lock. Prepare the tube with outer diameter of 1/4" for connection. The type of gas used in the unit is O₂. Prepare the gas container with capacity of 1.5 to 7m³. The gas container with dual pressure adjuster is useful.
- Adjust the secondary pressure to 1Kg/cm² if used.

Sample setting

1. Place the samples on the sample tray so they are placed evenly as possible. Use the well-dried samples. If they contain much moisture or are wet, the vacuum degree becomes unstable, that may result in tuning failure.
2. Push the front door once to open it. Put the sample tray onto the center of reaction tube.
3. Apply attached silicon grease on the O ring at reaction tube. Fit the ring into the groove on the reaction tube. Do not apply too much grease on the ring. It may be removed from the groove.

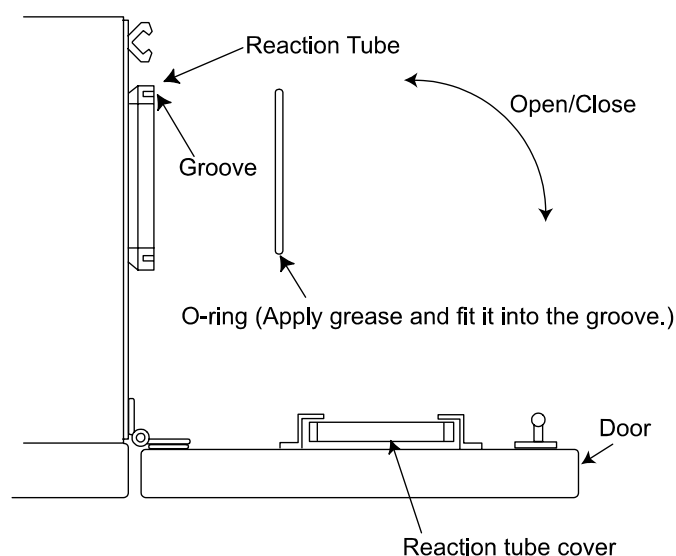

There is a possibility that silicone grease may be evaporated inside the reaction tube.

Operation Procedure

Check the followings before starting operation.

- Turn all switches and knobs to “OFF”, “MIN” or “CLOSE”.
- The ground of unit is surely connected.
- Gas piping is provided from the gas container to the inlet of O₂ gas. Adjust its secondary pressure to 1Kg/cm².
- Check that the power source to be used complies with specification of vacuum pump.
- Connect the power source of unit to 100VAC (50/60Hz).

1) Operation start

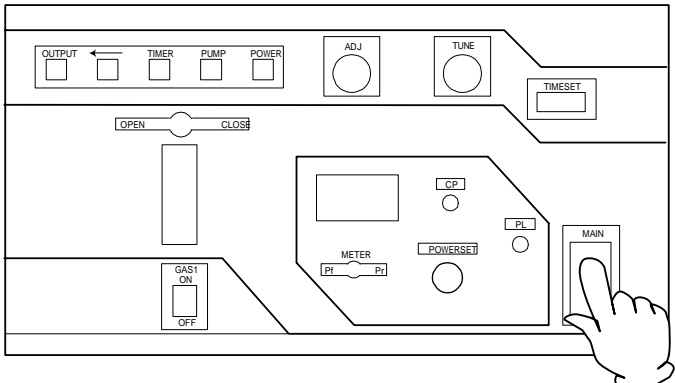
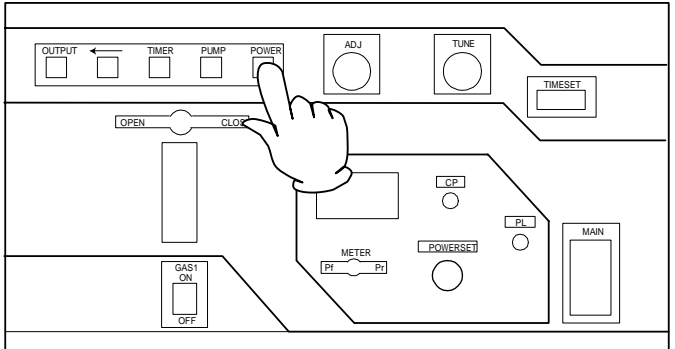
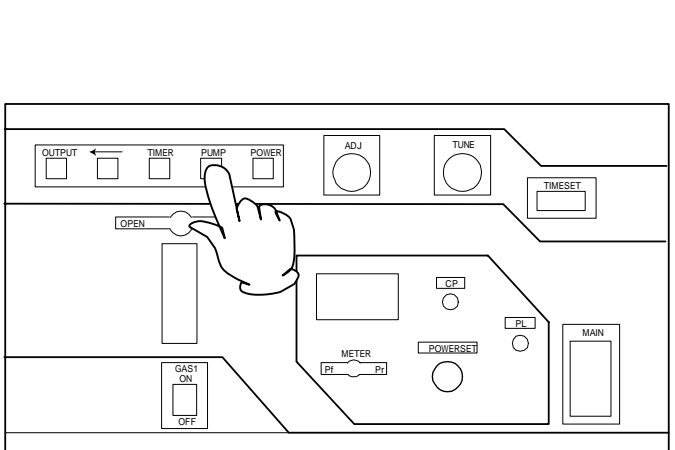
<p>1. Turn the MAIN switch to ON.</p>	 <p>The diagram shows the control panel with various switches and knobs. A hand is shown pointing to the MAIN switch, which is currently in the OFF position. Other visible components include the OUTPUT, TIMER, PUMP, and POWER switches, along with ADJ, TUNE, and TIMESET knobs.</p>
<p>2. The lamp lights on and the cooling fan starts to operate as the POWER switch is turned to ON. The solenoid valve for leak is turned to ON, too.</p>	 <p>The diagram shows the control panel with a hand pointing to the POWER switch, which is being turned to the ON position. The lamp and cooling fan are indicated to be active at this stage.</p>
<p>3. Evacuation starts and the lamp lights on as the PUMP switch is turned to ON. Pressure reduction is carried out at the glass capillary first, and then inside the reaction tube. After around one minutes, the main valve opens and reduction speed increase. After two minute, the yellow ready lamp lights on, where the OUTPUT switch is possible to be turned to ON.</p> <p>NOTE) In normal condition, the indicating needle on the vacuum meter swings as the PUMP switch is turned to ON. If the O-ring and cover on the reaction tube do not contact closely, it does not swing. In this case open the door and check that if the O-ring is fitted securely in the groove. If removed, apply grease on the ring and fit it to the groove again.</p>	 <p>The diagram shows the control panel with a hand pointing to the PUMP switch, which is being turned to the ON position. The vacuum meter is shown with a needle that has swung, indicating that the pump is operating.</p>

Operation Procedure

2) Generation of plasma

1. After the yellow ready lamp lights on, check that the vacuum meter reads around 0.1Mpa with the gas valve switch turned to OFF. Turn the gas valve switch to ON and needle valve knob to OPEN to adjust the setting flow rate (refer to the page 16).

NOTE) When a vacuum pump with low air displacement is used, the exhaust time may be longer.

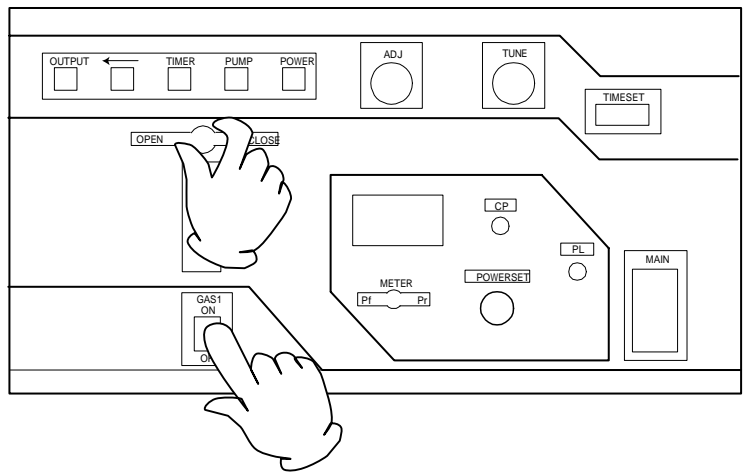

2. Turn the red OUTPUT switch to ON and meter selector switch to Pf. Generally turn the output control knob to MAX side.

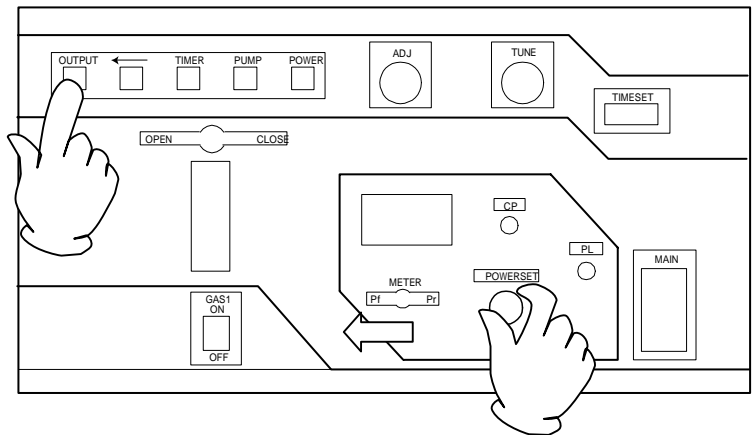

3. When the output reads around 40W, turn the meter selector switch to Pr, then TUNE and ADJ knobs to either right or left to minimize the meter. After that, turn the meter selector switch to Pf and adjust the output control knob to desired output. Then turn the meter selector switch to Pr and turn the TUNE and ADJ knobs to minimize the reflected power. Finally turn the meter selector switch to Pf to tune the output. Too large reflected power prevents the effective reaction. Refer to the table shown below for reflected power.

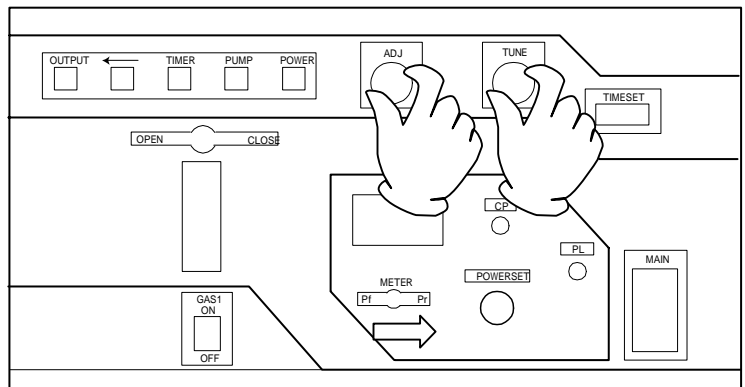

Output Power	Reflected Power
100W	4W
200W	8W
300W	12W

Operation Procedure

- ❖ The output and reflected power meter may read 1 to 2 watts after the output control knob is fully turned with the OUTPUT switch ON. This behavior is not abnormal, but sometimes occurs in normal condition because the output less than 2 watts is remained due to the characteristics of PWM control circuit.
- ❖ Check that plasma is generated at three chambers for tuning. Tuning may be difficult at the first stage of its generation. In this case turn up the output a little to make the tuning easier, or reduce the flow rate of gas to generate plasma easier. When the reflected power is larger than that in the table shown above depending on the flow rate of gas, turn the TUNE and ADJ knobs to either right or left to minimize the reflected power.

4. Timer

To apply high-frequency power for the definite period of time, set the desired period by setting the timer. Press the unit selector switch on the right edge to select the desired unit to be edited (hour/minute/second). Enter the numeric value with the switch. Turn the TIMER switch to ON after the setting is completed.

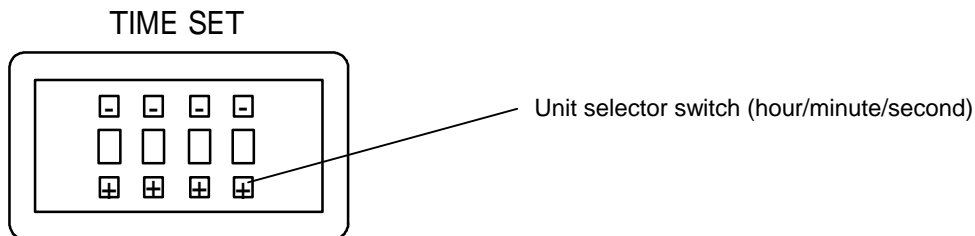

Press the unit selector switch to change the unit to be edited.
It changes in the order of "0.1s s 0.1m m 0.1h h 10h".

Operation Procedure

3) Sample unloading

The power of unit is turned to OFF and both the OUTPUT and ready lamps light off when the time is over if used.

The switches for vacuum pump and gas valve, however, remain to ON. Turn them to OFF and stop supplying gas before unloading the sample. The unloading procedures are as follows;

1. Turn the output control knob (OUTPUT) fully to the MIN and turn the OUTPUT switch to OFF.

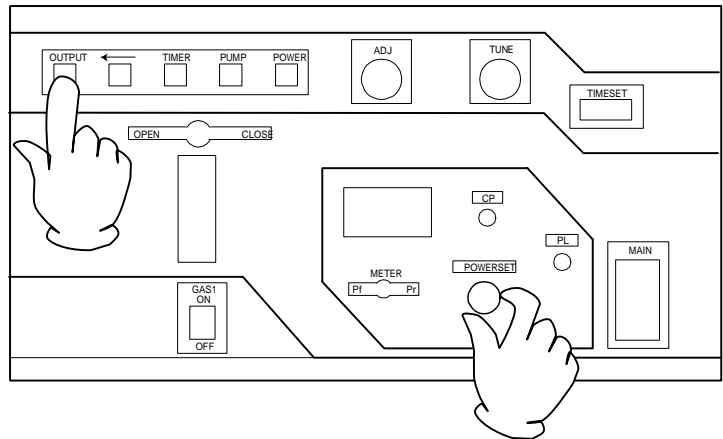

2. Turn the TIMER switch to OFF if used.
3. Turn the needle valve fully to CLOSE. Do not turn it too hard because the needle may be broken. Turn the O₂ gas valve switch to OFF.

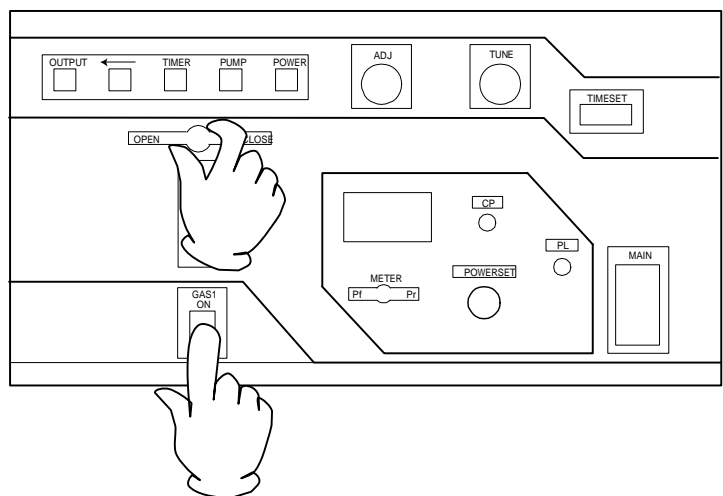

Operation Procedure

4. Turn the PUMP switch to OFF. The leak valve opens to reduce the pressure in the reaction tube to normal in 1 minute and 30 seconds.
5. After the pressure in the reaction tube is returned to normal, open the door of unit and unload the sample tray with tweezers. Be careful not to burn your skin because the temperature inside the unit is so high.

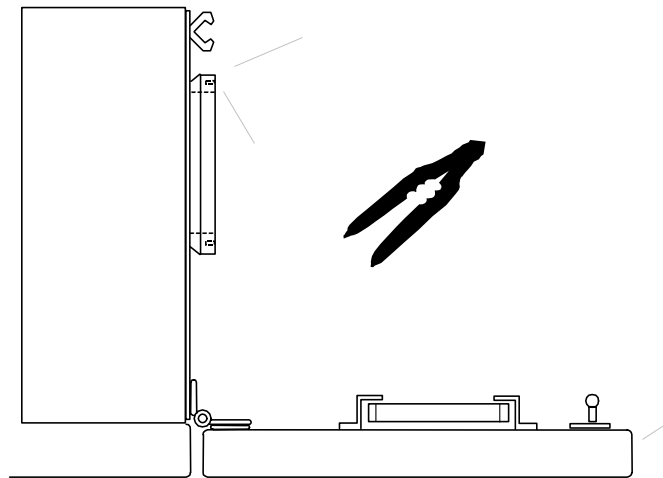

Be careful not to burn your skin because the temperature inside the unit is so high. Close the door after unloading the samples.

6. To treat other samples continuously, repeat the operation above. To end the operation, turn the POWER and MAIN switches to OFF.



The unit door is not open if the POWER switch is turned to OFF before the pressure inside the reaction tube completes to return to normal pressure because of the vacuum condition inside the tube. It may be broken if opened by force. In this case, turn the POWER switch to ON again and completely return the vacuumed pressure inside the tube to normal.

4) Sample treatment

1. Treatment possible:

This unit has a capability of ashing a large variety of organic matters such as rice, paper, yarn, meat, plastic, vinyl, fiber, cloth, plant, film, sludge, and dust.

Use the matter that is easy to be changed into the organic matter mentioned above under reduced pressure after providing reduced-pressure distillation. Use the matter with large water content after providing freeze dry. For explosives such as nitro compound or dyestuff, dispose them carefully and put into the unit by a little quantity.

2. Treatment impossible:

The matters easily to be melted or flied by high temperature inside the reaction tube, or sublimatics

3. Note:

There is a possibility that the samples expand or fly because the reaction is processed rapidly if a high electric power is applied at the first stage of treatment. The ashing speed may also decrease due to carbonization or compression. Please carry out ashing with low electric power at the first stage of treatment, and increase it after some time has passed. Refer to the table below for the optimum oxygen flow rate (around 1/3 of power output).

Output	Optimum Oxygen Flow Rate
300W	100CC
200W	70CC
100W	30CC

(Example)

WARNING!

If a problem occurs

-  If smoke or strange odor should come out of this unit for some reason, turn off the power key right away, and then turn off the breaker and the main power. Immediately contact a service technician for inspection. If this procedure is not followed, fire or electrical shock may result. Never perform repair work yourself, since it is dangerous and not recommended.

Substances that cannot be used

-  Never use explosive substances, flammable substances and substances that include explosive or flammable ingredients in this unit. Explosion or fire may occur. (Refer to page26 “List of Dangerous Substances”.)

CAUTION!

Overload capacity

-  Do not put too much samples in the unit in order to achieve its performance sufficiently. The load (sample quantity) should be 5% or less of chamber capacity.

Do not step on this unit

-  Do not step on this unit. It will cause injury if this unit fall down or break.

Do not put anything on this unit

-  Do not put anything on this unit. It will cause injury if fall.

During a thunder storm

-  During a thunderstorm, turn off the power key immediately, then turn off the breaker and the main power. If this procedure is not followed, fire or electrical shock may be caused.

Do not touch high-temperature parts

-  Some parts of this unit become hot during and just after operation. It may cause burns.

Adjust gas pressure

-  Adjust the gas pressure with a pressure controller so its secondary pressure be less than 1Kg/cm² when supplied from the gas container to the inlet.

Do not make impact

-  Do not make an impact on the reaction tube or unit with the tube vacuumed. The tube may burst.

Use oxygen gas only

-  This ashing unit uses oxygen gas. Using the other kinds of gas may result in unit failure.

CAUTION!

Effect of high-frequency wave



When operating other devices in parallel with this unit, they may be affected with high-frequency wave. Leave them as long distance as possible from this unit if unavoidable. Do not use the same power supply line as that for this unit.

As for gas to use



Depends on the use of gas ultraviolet rays will be send out because of plasma and there will be the possibility to have ozone evolution reacting against enzyme in air. In this case keep the room be well-ventilated or installing duct or other kind of equipment on this devise to exhaust the air outside.

Daily Inspection and Maintenance

WARNING!

- Disconnect the power cable from the power source when doing an inspection or maintenance unless needed.
- Perform the daily inspection and maintenance after returning the temperature of this unit to the normal one.
- Do not disassemble this unit.

CAUTION!

- Use a well-drained soft cloth to wipe dirt on this unit. Do not use benzene, thinner or cleanser for wiping. Do not scrub this unit. Deformation, deterioration or color change may result in.

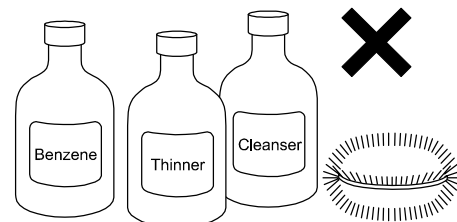

Monthly maintenance

- Check the earth leakage breaker function.
 1. Connect the power cord.
 2. Turn the breaker on.
 3. Push the red test switch by a ballpoint pen etc.
 4. If there is no problem, the earth leakage breaker will be turned off.

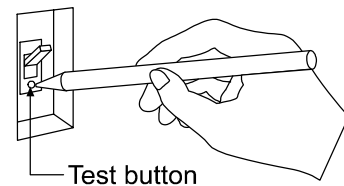

Oil exchange on vacuum pump

- Clean the vacuum pump and exchange the oil once in one or two months (the period depends on the frequency/pressure of use). If not, the performance of pump and its efficiency may degrade.

Sample tray cleaning

- Clean the sample tray after use with chromic acid mixture (recommended).

For any questions, contact the dealer who you purchased this unit from, or the nearest sales division in our company.

When not using this unit for long term / When disposing

CAUTION!

When not using this unit for long term...

- Turn off the power and disconnect the power cord.

WARNING!

When disposing...

- Keep out of reach of children.
- Treat as large trash.

Environmental protection should be considered

We request you to disassemble this unit as possible and recycle the reusable parts considering to the environmental protection. The feature components of this unit and materials used are listed below.

Component Name	Material
Parts of Main Unit	
Exterior	Iron steel plate
Interior	Stainless steel SUS304, Aluminum, Grass (Pylex)
Production plates	Polyethylene (PET) resin film
Knob	Resin Rubber, SUS304
Electrical Parts	
Switch, Relays	Resin, Composites of copper and other
Boards	Composites of grass fiber and other
Power Cord	Composites of synthetic rubber, copper, nickel etc.
Fan motor	Composites of synthetic aluminum, copper, resin etc.
Piping parts	Copper, Stainless steel, Teflon

Trouble Shooting

Condition	Check the following
Pump does not operate though PUMP switch is pressed.	<ul style="list-style-type: none">• Check if the power source for vacuum pump is turned to ON.• Check if the door of reaction tube is closed.• Check if the cable for pump is connected securely.
Degree of vacuum not good	<ul style="list-style-type: none">• Check if the reaction tube and cover contacts closely.• Check if vacuum leakage exists.
No RF output	<ul style="list-style-type: none">• Check if the door of chamber and/or top board is closed.
Matching is not provided.	<ul style="list-style-type: none">• Check if the degree of vacuum is good.

In the case if the error other than listed above occurred, turn off the power switch and primary power source immediately. Contact the shop of your purchase or nearest Yamato Scientific Service Office.

In Case of Request for Repair

If the failure occurs, stop the operation, turn OFF the power switch, and unplug the power plug. Please contact the sales agency that this unit was purchased, or the Yamato Scientific's sales office.

< Check following items before contact >

Model Name of Product	}	See the production plate attached to this unit.
Production Number		
Purchase Date		
About Trouble (in detail as possible)		

Minimum Retention Period of Performance Parts for Repair

The minimum retention period of performance parts for repair of this unit is 7 years after discontinuance of this unit.

The "performance part for repair" is the part that is required to maintain this unit.

Model	PR300
High-frequency power	0 to 300W continuous variable
Oscillation frequency	13.56MHz crystal oscillation
Output impedance	50
End element	FET (field effect transistor)
Timer	0.1sec to 999h can be set.
Attached instruments	Output/Reflected power meter (0 to 300W) Flow meter (O ₂ 30 to 300 ml / min) Vacuum meter (Bourdon gauge 0 to 0.1MPa)
Tuning method	Two axle manual tuning
Used gas	O ₂ , CF ₄
Gas inlet	1/4" swage lock
Protection circuit	Protection of build-in power supply (shut down) at load unconformity (power down) and at over power of circuit breaker
Power supply	100V AC (1 50/60Hz) 10A
Reaction tube	Pylex
Reaction tube dimensions	64 × 160mm, three tubes
Structure of electrodes	Capacitor type, two-divided
Control system	Automatic pressure reduction, auto leak valve
Piping material	SUS304 and 316, Copper, Copper alloy, Teflon piping
Vacuum pump inlet	NW25 flange type
External dimensions	438(W) × 520(D) × 556(H) mm
Weight	Approx. 36Kg
Standard accessories	Vacuum grease(1), O ring for reaction tube(6), Sample tray(large and small), Shelf, Plug for pump cable(2)Instruction manual,

Optional Accessories

		Displacement	Power supply
Vacuum pump	Standard	2008A 160 ℓ / min	AC100/200 3
	Chemical	2008AC 160 ℓ / min	AC100/200 3
Vacuum hose	Silicon: 20 × 40 × 1m Flexible tube: NW25 flange equipped 0.5/1.0/1.5/2m		
Rubber tube adapter	NW25		
Center ring	NW25	Neopullen	- A ℓ
	NW25	Byton	- SUS304
Clamp	NW25		

Peripheral devices

- Oxygen gas container: 7000 ℓ including gas
- Oxygen pressure control device
- Motor lorry to carry gas container: (large size: 7000 ℓ)
- Gas container frame

Wiring Diagram

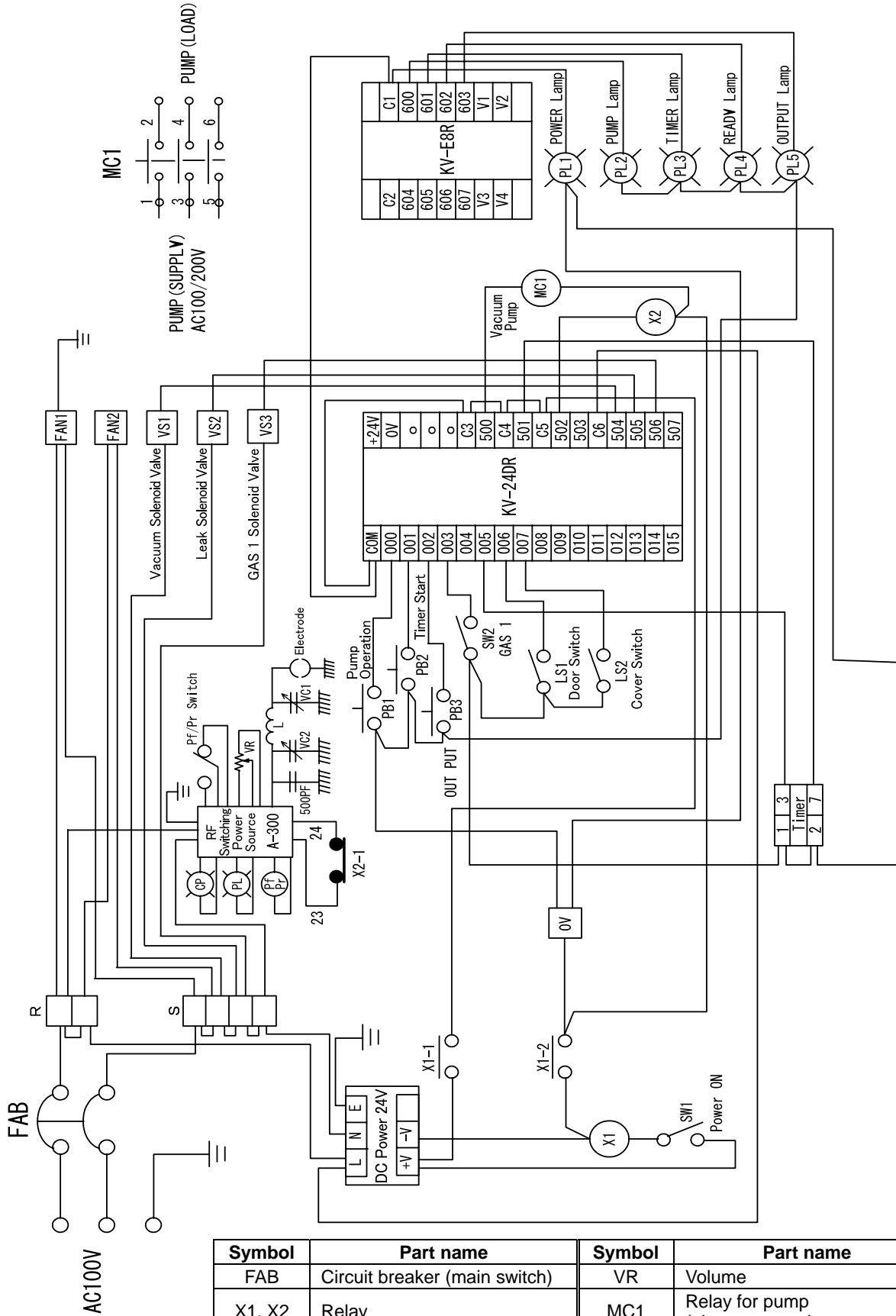

Symbol	Part name	Symbol	Part name
FAB	Circuit breaker (main switch)	VR	Volume
X1, X2	Relay	MC1	Relay for pump (electromagnetic contactor)
FAN1 FAN2	Fan	VC1 VC2	Variable condenser
Pf	Output display	L	Coil
Pr	Reflected wave display		

Replacement Parts Table

Part Name	Code No.	Specification	Manufacturer
Reaction tube	1027	Pylex	Yamato Scientific
Capillary (1)	1029	Pylex	Yamato Scientific
Capillary (2)	1030	Pylex	Yamato Scientific
Gas branch pipe	1031	Pylex	Yamato Scientific
Exhaust branch pipe	1032	Pylex	Yamato Scientific
Vacuum meter	1034	DU-1/4B 50 × 0.1MPa	Toyo Keiki Kogyo
Solenoid valve	1021	HBV41-8N-5 AC100V	CKD
Solenoid valve	1022	HBV112-6N-5 AC100V	CKD
Fan	3030	MB630-B	Oriental
Limit switch	3034	D4MC-5000	Omron
High-frequency power source	3051	RF-300Y	Yamato Scientific
DC power source	3002	KV-U3	Keyence
Flow meter	1136	RK1200-12-SS-1/4-O2 300mL/min 1K-O-U	KOFLOK
Digital timer	3008	H 3CA-8 DC24V	Omron
Command switch	3038	A3SA-90D1-24EW	Omron
Command switch	3039	A3SA-90D1-24ER	Omron
Locker switch	3042	JW-S11RKK	Nickai
Circuit breaker	3043	BAM2-15-031	Matsushita
Matching variable condenser	3052	800PF	Tokyo High Power
Matching variable condenser	3053	180PF	Tokyo High Power
Relay	3023	MY2N-DC24V	Omron
Contactactor	3004	J7AN-E3 DC24V	Omron
Limit switch	3035	V-56-1A4	Omron
O-ring	4031	G 75	Yamato Scientific
Reaction tube cover	1028	Pylex	Yamato Scientific

Refer to the described code No. for the part to be replaced.

List of Dangerous Substances



Never use explosive substances, flammable substances and substances that include explosive or flammable ingredients in this unit.

EXPLOSIVE

EXPLOSIVE:	Ethylene glycol dinitrate (nitro glycol), Glycerin trinitrate (nitroglycerine), Cellulose nitrate (nitrocellulose), and other explosive nitrate esters
	Trinitrobenzene, Trinitrotoluene, Trinitrophenol (picric acid), and other explosive nitro compounds
	Acetyl hidroperoxide (peracetic acid), Methyl ethyl ketone peroxide, Benzyl peroxide, and other organic peroxides

FLAMMABLE

IGNITING:	Lithium (metal), Potassium (metal), Sodium (metal), Yellow phosphorus, Phosphorus sulfide, Red phosphorus, Celluloid compounds, Calcium carbide, Lime phosphate, Magnesium (powder), Aluminum (powder), Powder of metals other than magnesium and aluminum, Sodium hydrosulfite
OXIDIZING:	Potassium chlorate, Sodium chlorate, Ammonium chlorate, and other chlorate
	Potassium perchlorate, Sodium perchlorate, Ammonium perchlorate, and other perchlorate
	Potassium peroxide, Sodium peroxide, Barium peroxide, and other inorganic peroxide
	Potassium nitrate, Sodium nitrate, Ammonium nitrate, and other nitrate
	Sodium chlorite and other chlorites
	Calcium hypochlorite and other hypochlorites
INFLAMMABLE LIQUID:	Ethyl ether, Gasoline, Acetaldehyde, Propylene chloride, Carbon disulfide, and other flammable substances having a flash point of lower than -30
	Normal hexane, ethylene oxide, acetone, benzene, methyl ethyl ketone, and other flammable substances having a flash point of -30 or higher but lower than 0
	Methanol, Ethanol, Xylene, Pentyl acetate (amyl acetate), and other flammable substances having a flash point of 0 or higher but lower than 30
	Kerosene, Light oil (gas oil), Oil of turpentine, Isopentyl alcohol (isoamyl alcohol), Acetic acid, and other flammable substances having a flash point of 30 or higher but lower than 65
FLAMMABLE GAS:	Hydrogen, Acetylene, Ethylene, Methane, Propane, Butane, and other flammable substances which assume a gaseous state at 15 and 1 atm

(Source: Appendix Table 1 of Article 6 of the Industrial Safety and Health Order in Japan)

Responsibility

Please follow the instructions in this document when using this unit. Yamato Scientific has no responsibility for the accidents or breakdown of device if it is used with a failure to comply. Never conduct what this document forbids. Unexpected accidents or breakdown may result in.

Note

The contents of this document may be changed in future without notice. Any books with missing pages or disorderly binding may be replaced.

Instruction Manual for

**Plasma Reactor
Model PR 300**

First Edition Mar.. 30, 2001

Yamato Scientific Co., Ltd.

2-1-6 Nihonnbashi Honcho, Chuo-ku,
Tokyo, 103-8432, Japan

<http://www.yamato-net.co.jp>