

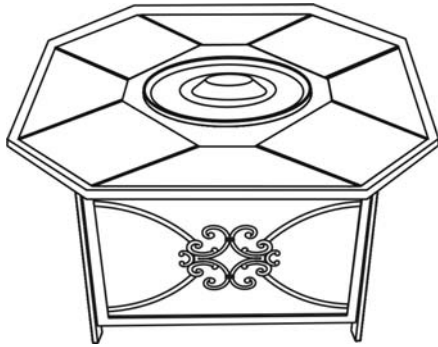

**LOWELL BAY W6003FIRE (ARH10600)  
 HEX KD FIREPIT W/PORCELAIN TILE  
 TOP & SIDE W/LAVA ROCK  
 RUSSET FINISH  
 ASSEMBLY INSTRUCTIONS**



**CSA Model 99000**

Installer: Leave these instructions with consumer.

Consumer: Keep these instructions for future reference.

**⚠ DANGER**

**If you smell gas:**

1. Shut off gas to the appliance.
2. Extinguish any open flame.
3. If odor continues, keep away from the appliance and immediately call your gas supplier or fire department.

**⚠ WARNING:**

**Improper installation, adjustment alteration, service or maintenance can cause injury or property damage. Read the installation, operating and maintenance instructions thoroughly before installing or servicing this equipment.**



**WARNING: For Outdoor Use Only**

**⚠ WARNING**

**Do not store or use gasoline or other flammable vapors and liquids in the vicinity of this or any other appliance. An LP-cylinder not connected for use shall not be stored in the vicinity of this or any other appliance.**

**FOR USE WITH 20LB (9KG) PROPANE CYLINDER WITH TYPE 1 CONNECTION OR FOR USE WITH NATURAL GAS AFTER CONVERSION KIT IS INSTALLED (MUST BE PROFESSIONALLY INSTALLED) ALSO THE LP REGULATOR MUST BE SUPPLIED BY THE MANUFACTURER.**

**WARNING:**

**USE FACTORY APPROVED REPLACEMENT PARTS AND ACCESSORIES ONLY. USE OF UNAPPROVED PART OR ACCESSORIES CAN VOID THE WARRANTY ON THIS PRODUCT AND RESULT IN AHAZARDOUS CONDITION. PLEASE CONTACT US FOR INFORMATION REGARDING REPLACEMENT HOSES, THERMOCOUPLES, ELECTRODES, IGNITION MODULES, LAVAROCKS, LOGS, FIRE ICE, ETC.**

**⚠ DANGER**

**CARBON MONOXIDE HAZARD**



**This appliance can produce carbon monoxide which has no odor. Using it in an enclosed space can kill you. Never use this appliance in an enclosed space such as a camper, tent, car or home.**

# TABLE OF CONTENTS

Important Safety Information	3
Important About Propane	4
Specification	4
Parts Identification List	5-6
Installation	7-11
Batteries	12
Lighting Instructions	12
Maintenance	13
Troubleshooting Guide	13

## IMPORTANT SAFETY INFORMATION

The installation must conform with local codes or, in the absence of local codes, with the National Fuel Gas Code, ANSI Z223.1/NFPA 54; International Fuel Gas Code. ; Natural Gas and Propane Installation Code, CSA B149.1; or Propane Storage and Handling Code, B149.2, as applicable).

The appliance must be isolated from the gas supply piping system by closing its equipment shutoff valve during any pressure testing of the gas supply system at test pressure equal to or less than 1/2 psi (3.5kPa).

The appliance area must be kept clear and free from combustible materials, gasoline and other flammable vapors and liquids.

Do not use this appliance if any part has been under water. Immediately call a qualified service technician to inspect the appliance and to replace any part of the control system and any gas control which has been under water.

**Children and adults should be alerted to the hazards of high surface temperatures and kept at a safe distance to avoid burns or clothing ignition.**

**Young children should be carefully supervised when they are anywhere near the appliance.**

**Clothing or other flammable material should not be hung from the appliance, or placed on or near the appliance.**

**Any screen or guard removed for servicing an appliance must be replaced prior to operating the appliance.**

**Installation and repair should be done by a qualified service person. The appliance should be inspected before use and at least annually by a professional service person. More frequent cleaning may be required as necessary. It is imperative that the control compartments, burners and circulating air passageways of the appliance be kept clean.**

Do NOT burn solid fuels in this gas fireplace.

**CAUTION:** The propane gas pressure regulator provided with this appliance must be used. This regulator is set for an outlet pressure of 11 inches water column.

This outdoor gas appliance is not intended to be installed in or on recreational vehicles and/or boats.

Before each use of this gas appliance, open the LP (Liquid Propane) Tank Drawer and inspect the LP Hose. If there is evidence of excessive abrasion or wear, or the hose is cut, it must be replaced prior to the gas appliance being put into operation. Use only the replacement hose assembly specified in this manual. Inspect the burner before each use of the appliance. The burner must be replaced prior to the appliance being put into operation if it is evident that the burner is damaged. Use only the burner listed in these instructions.

Keep the fuel supply hose away from any heated surfaces.

## IMPORTANT SAFETY INFORMATION ABOUT PROPANE (LP) GAS

A self contained LP-gas cylinder for use with this appliance must have a capacity of 20 lbs. and must be equipped with a Type 1 connector and an OPD (overfill protection device). See Figure 1.

The LP-gas supply cylinder to be used must be constructed and marked in accordance with the specification for LP-gas cylinders of the U.S. Department of Transportation (DOT) or the National Standard of Canada, *CAN/CSA-B339, Cylinder, Sphere and Tubes for the Transportation of Dangerous Goods*.

- The cylinder supply system must be arranged for vapor withdrawal.
- The cylinder used must include a collar to protect the cylinder valve.
- This appliance shall be used only outdoors in a well-ventilated space and shall not be used in a building, garage or any other enclosed space.
- When this appliance is not in use, the gas must be turned off at the supply cylinder.
- Storage of this appliance indoors is permissible only if the cylinder is disconnected and removed from the appliance.
- Cylinders must be stored outdoors in a well-ventilated area out of the reach of children. Disconnected cylinders must have threaded valve plugs tightly installed and must not be stored in a building, garage or any other enclosed areas.

CSA (Canadian Standards Association) certified to ANSI Z21.97•CSA 2.41-2012  
“Outdoor Decorative Gas Appliances”

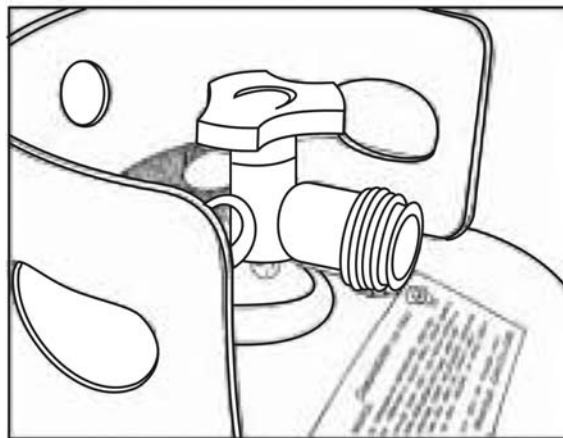











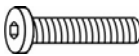



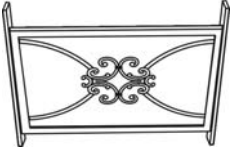

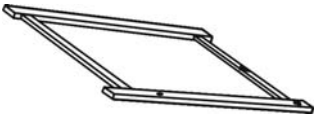
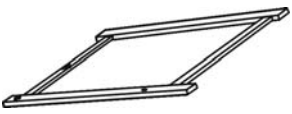

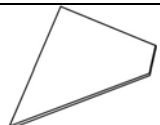
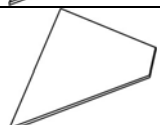
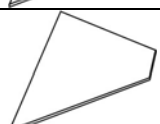
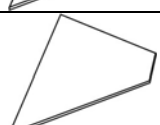
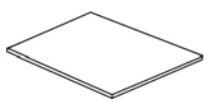

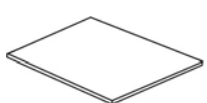
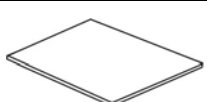

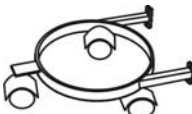
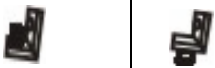

Figure 1

## SPECIFICATIONS

INPUT	40,000 Btu/hr	30,000 Btu/hr Low fire
Propane Regulator Pressure	11 inches water column	
Clearances to combustible surfaces	Sides 24in./61cm	Top: 72 in. / 183 cm

## PARTS IDENTIFICATION LIST

	PART	DESCRIPTION	PART#	QTY
A		CONTROL KNOB	FP0245	1
B		GAS VALVE	FP0307	1
C		THERMOCOUPLE	FP0004	1
D		LP REGULATOR HOSE	FP0308	1
E		ELECTRODE	FP0003	1
F		ORIFICE ELBOW	FP0310	1
G		IGNITION MODULE	FP0006	1
H		PROPANE ORIFICE	FP0312	1
I		HEX WRENCH	HW0008	1
J		HEX BOLT DRIVER	HW0006	1
K		FOOTCAP	FC0559	8
L		1/4" X 15 MM BOLT	HW0034	12
M		1/4" X 40 MM BOLT	HW0086	4
N		NUTS	HW0719	2
O		BOLT COVER	HW0105	18
P		Ø6.5 X 1.0MM WASHERS	HW0004	18
Q		FIRE PIT TABLETOP	FP1237	1
R		BACK PANEL	FP1238	1

S		LEFT SIDE PANEL	FP1239	1
T		RIGHT SIDE PANEL	FP1240	1
U		DOOR PANEL	FP1241	1
V		TILE-1	FP1242	1
W		TILE-2	FP1242	1
X		TILE-3	FP1242	1
Y		TILE-4	FP1242	1
Z		TILE-5	FP1243	1
AA		TILE-6	FP1243	1
BB		TILE-7	FP1243	1
CC		TILE-8	FP1243	1
DD		MIDDLE SUPPORT	FP1244	1
EE		LP SUPPORT	FP1245	1
FF		BOTTOM / TOP CONNECTOR	FP0677 / FP0678	1
GG		LAVA ROCKS	FP0002	1

# INSTALLATION

1. Identify parts packed in carton against the parts list. Remove all protective materials and set parts on a flat, non-abrasive surface.

2. Attach the back panel to side panels by using four 1/4"x40 mm bolts and washers as shown in Figure 2. Guide bolts through holes in back panel, into pre-drilled holes in the side panels. **Hand tighten only.**

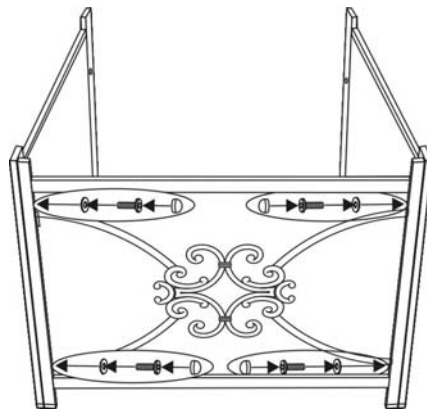

Figure 2

3. Attach the middle support to side panels by using four 1/4"x15 mm bolts and washers as shown in Figure 3. Guide bolts through holes in middle support, into pre-drilled holes in the side panels. **Hand tighten only.**



Figure 3

4. Attach the bottom connector to right side panel by using a 1/4"x15 mm bolt and washer as shown in Figure 4. Guide the bolt through hole in bottom connector, into the pre-drilled hole in the right side panel. **Do not over tighten.**

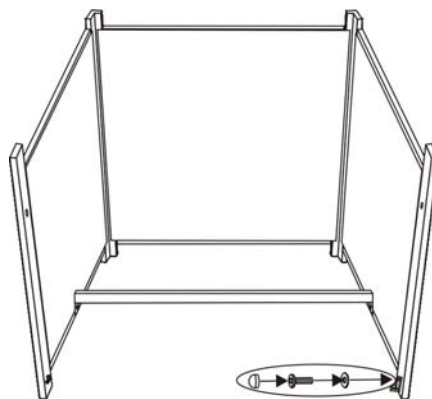

Figure 4

5. Put the door onto the bottom connector by guiding the pin in the bottom connector into the hole under the door. Then guide the pin in the top connector into the hole on the top of the door. Use a 1/4"x15 mm bolt and washer to attach the top connector to the right side panel as shown in Figure 5. **Do not over tighten.**

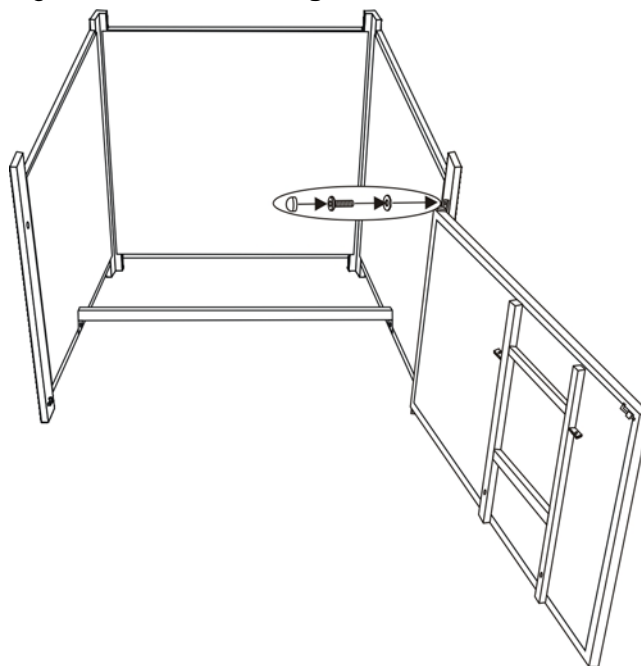

Figure 5

6. With the help of another person, carefully place the table top onto the table base. After making any necessary adjustments to the alignment of the table top and the assembled base, use four 1/4"x15 mm bolts and washers as shown in Figure 6. Guide the bolts through the holes in the side panels, into the pre-drilled holes in the table top. **Do not tighten completely.**

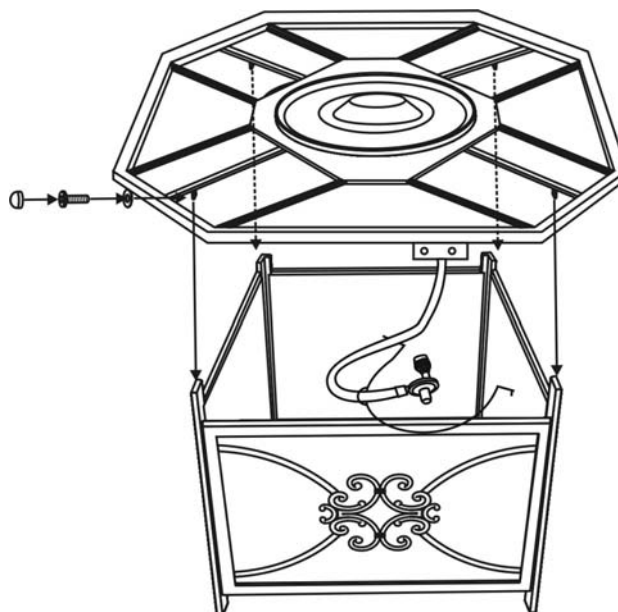

Figure 6



7. Attach the LP support to door panel by using four 1/4"x15 mm bolts and washers as shown in Figure 7. **Do not over tighten.**

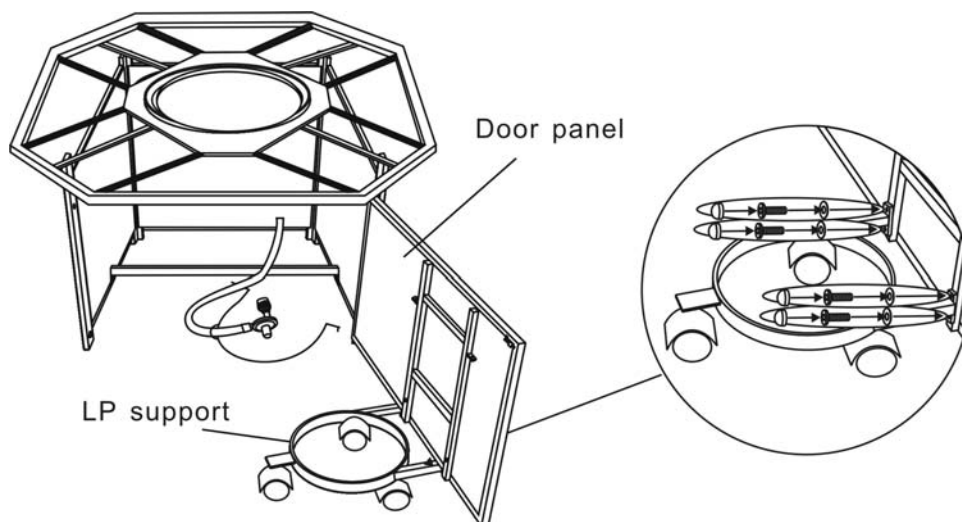

Figure 7

8. Place gas tank onto the LP support as shown in Figure 8.

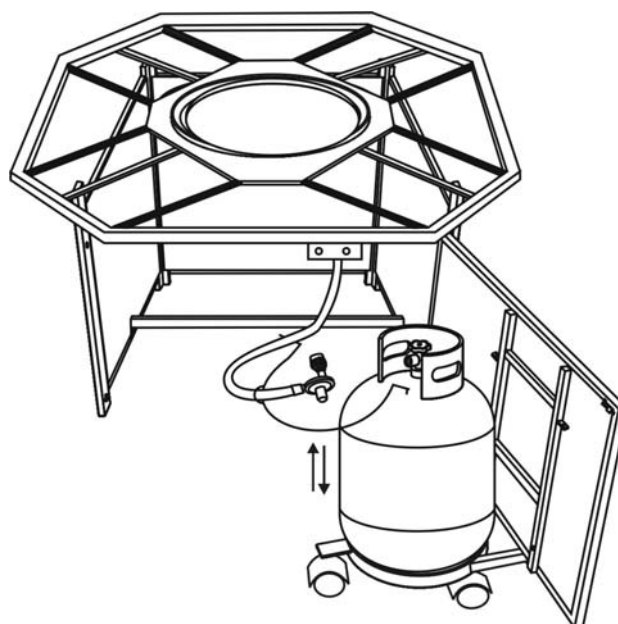

Figure 8

9. Attach the metal ring ( as shown in Figure 9) pre-fitted with gas hose which is connected to the table top , into the hole of the door panel, then use hex bolt driver to tighten the 1/4"x5mm nut , the gas tank has fixed as shown in Figure 9a. Connect the regulator as shown in Figure.10. Turn the black handle clock-wise to tighten. Turn the handle counter clock-wise to remove. The hose must point down. Check that the valve is turned all the way clockwise to the "OFF" position.

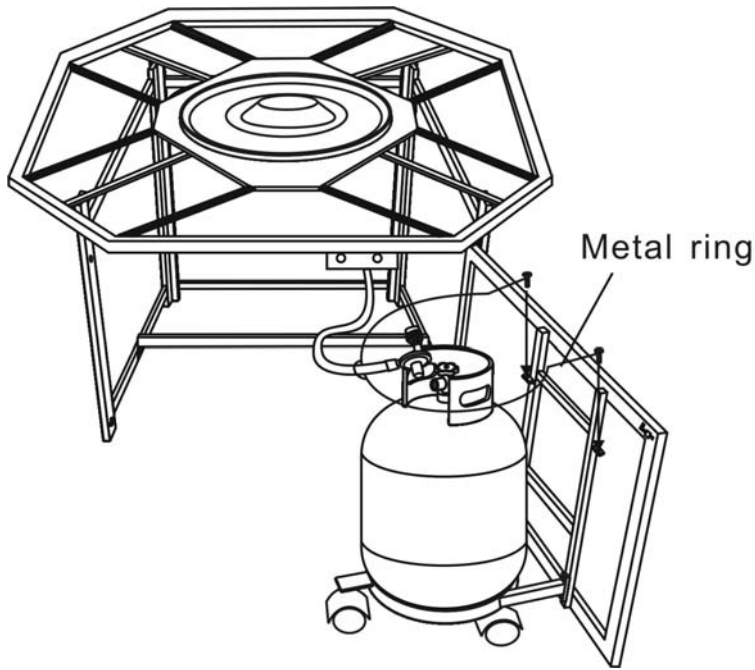

Figure 9

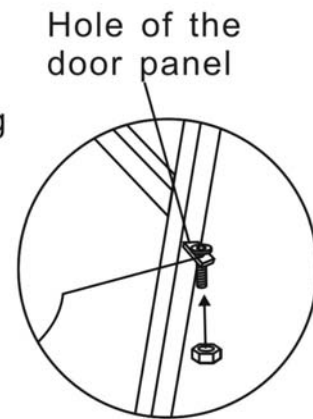

Figure 9a

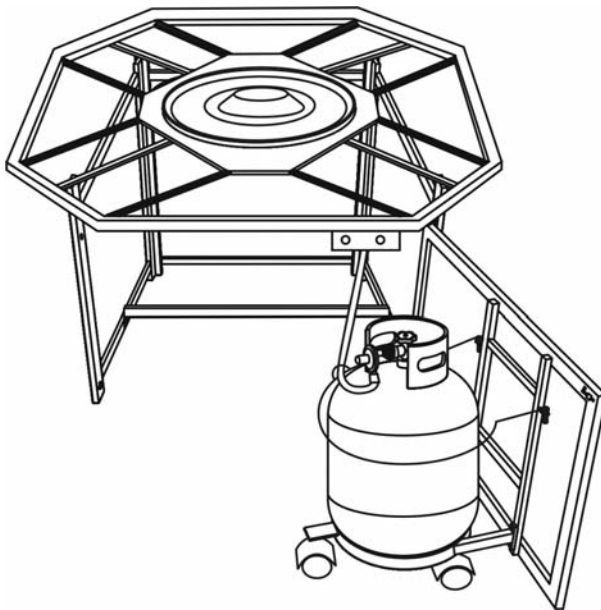
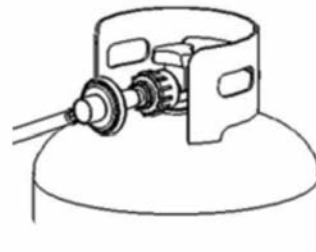

Figure 10



10. After making any necessary adjustments to the parts, use the hex bolt driver to tighten all bolts. Note: each bolt must be tightened a few revolutions at a time. Repeat until all bolts are tight. Do not over tighten. Over tightening may strip bolts. Cover all bolts with covers.

11. Note the clear bumpers spaced evenly throughout the inside of the table top. Carefully place the tiles inside the table top, resting on the clear bumpers as shown in Figure 11.

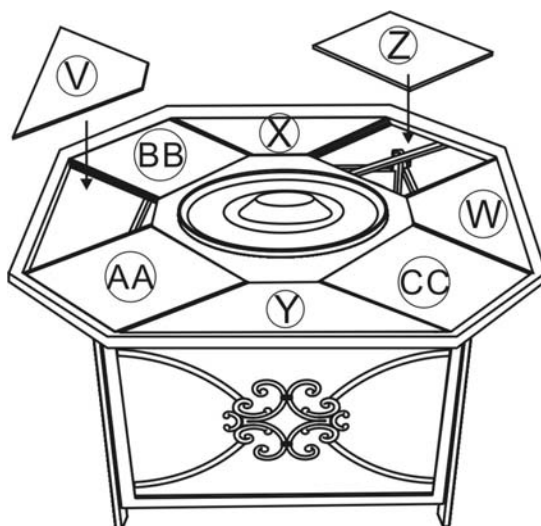

Figure 11

12. Pour the lava rocks into the burner pan completely covering the burner. See Figure 12.

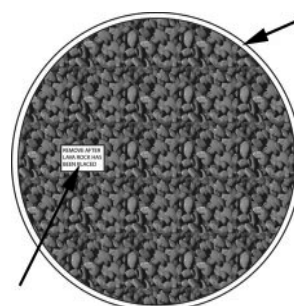
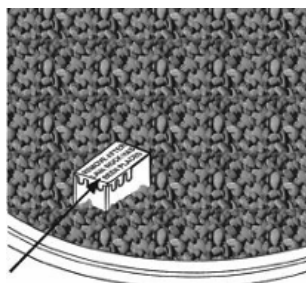

Figure 12

**Ignition Well**

13. Remove the cardboard cover from the ignition well as shown in Figure 13. Remove any lava rock or fire ice on top of ignition well.



**Cardboard Cover**

Figure 13

14. Open the tank valve. Apply a solution of soapy water to the tank-regulator connection and to the valve-hose connection to check for leaks as shown in Figure 14. If soap bubbles continue to form, the connection has a leak. If a leak is found, close the tank valve and tighten all connections.

**NOTE: NEVER USE A FLAME TO CHECK FOR LEAKS.**

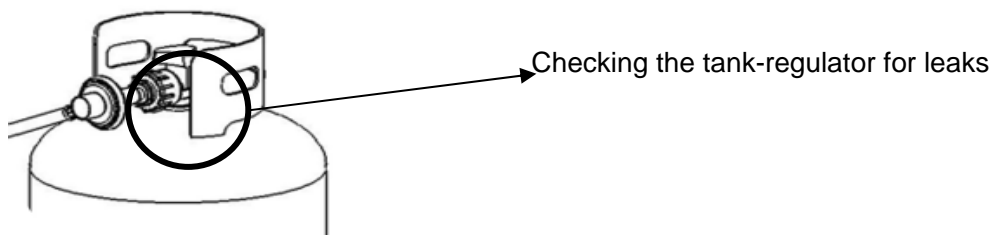

Figure 14

# BATTERIES

Make sure the control knob is in the "OFF" position.

Unscrew the push button cap on the ignition module located on the control panel to access the battery compartment. The ignition module requires one Alkaline AAA size battery (1.5V). The negative (-) end goes in first. See Figure 15.

Dispose of battery safely. May explode or leak if charged or disposed of in fire. Make sure of the polarity. Mercury and cadmium free.

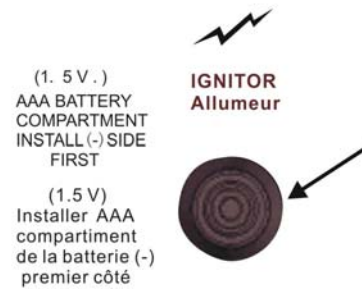

Figure 15

# LIGHTING INSTRUCTIONS

Warning: If these instructions are not followed exactly, a fire or explosion may result causing property damage, personal injury or loss of life.

1. Make sure the control knob is in the "OFF" position. See Figure 16 Open the tank valve all the way.



IGNITER BUTTON

Figure 16

CONTROL KNOB

2. Push in the igniter button. You will hear a slight clicking sound. With the igniter button pushed in, push and turn the control knob to the "ON" position. the fire should light within a few seconds. Once the flame is lit, release the igniter button and continue to hold the control knob in for 10 to 15 seconds. Release the control knob. The control knob should pop back out and then remain lit.

Note: If the fire does not light, turn the knob to the "OFF" position and wait five (5) minutes before trying again.

3. To turn down the flame, push the control knob in slightly and turn to Medium (medium or Low (small flame)).

4. To shut down the fire pit, turn the control knob to the "OFF" position and turn off the tank valve.

## MAINTENANCE

The flames should look like those in Figure 17. To clean the burner, use a soft brush after the burner has cooled completely. Never use a vacuum cleaner on the burner. It is recommended that the fire pit be stored indoors during the winter if it will be subjected to freezing temperatures. The LP cylinder must be disconnected and removed from the appliance before the appliance can be stored indoors.



Figure 17

Always purchase the correct size and grade of battery most suitable for the intended use. Replace all batteries of a set at the same time. Clean the battery contacts and also those of the device prior to battery installation. Ensure batteries are installed correctly with regard to polarity (+ and -). Remove batteries from equipment which is not to be used for an extended period of time. Remove used batteries promptly.

## TROUBLESHOOTING GUIDE

PROBLEM	CAUSE	REMEDY
Burner won't light	No Propane Gas at Burner	Check that gas tank valve is open. Turn control knob to "ON" and push control knob in. Make sure tank has propane gas.
	No Spark at Electrode	Check that AAA battery is installed with negative (-) end first and has a charge. Check that the wire is connected to the ignition module. Check that the electrode is not cracked or broken.
	Lack of oxygen	Remove excess lava rocks or fire ices from around the ignition well.
Burner won't stay lit after lighting	Thermocouple not in flame	Check that the tip of the thermocouple is even with the top of the ignition well. Remove any lava rocks from the ignition well.
	Thermocouple connection at the main control valve is loose	Tighten the thermocouple nut at the back of the valve.
	No Lava Rocks on Burner	Cover the burner with lava rocks per the instructions