

bartolini

1E and 4E TRIPLE COIL BASS PICKUPS

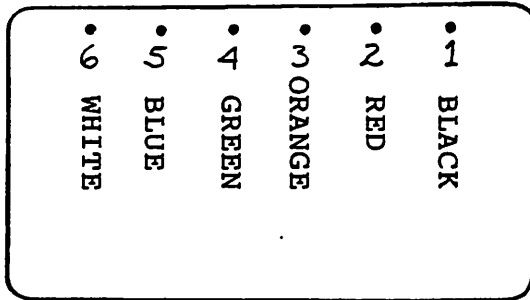

- 1. } string sensing coil
- 2. } (South polarity)
- 3. } hum cancelling coil
- 4. }
- 5. } string sensing coil
- 6. } (North polarity)

The 1E pickup is a large humbucker size, triple coil pickup. The 4E is larger (1½ x 3 inches) and is intended for the wider string width of long scale basses. Each pickup has 2 string sensing coils and 1 passive hum cancelling coil that can be connected to give different tonal qualities without hum. The pickup is factory wired in the humbucker series mode. Both sensing coils are wired in series to form a wide aperture humbucking system.

Each sensing coil can be connected to the hum canceller to achieve hum-free single coil sound. Any coil pair can be wired in series (more output) or in parallel (brighter sound).

HUMBUCKER (wide aperture) MODES

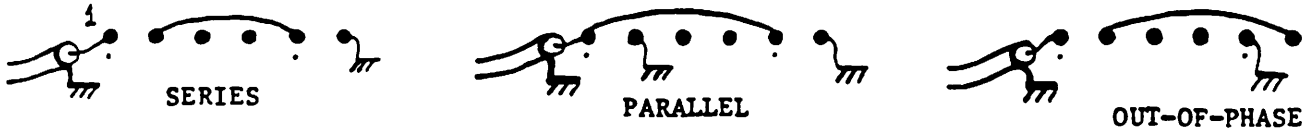

SINGLE COIL (narrow aperture) MODES

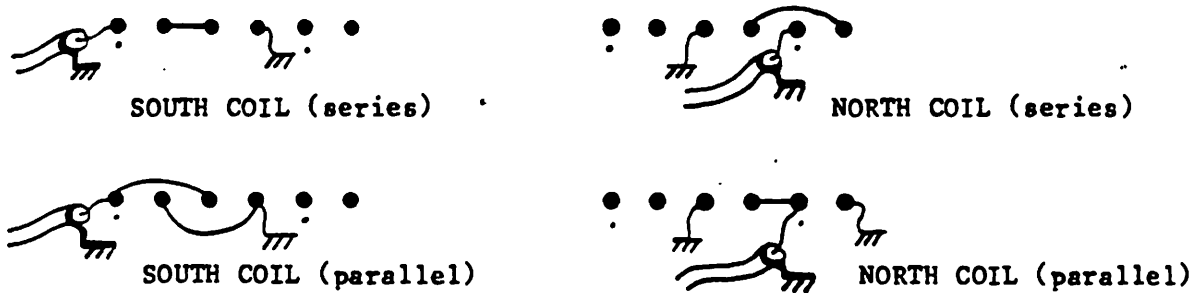

HUMBUCKER to SINGLE COIL switching (DPDT switches)

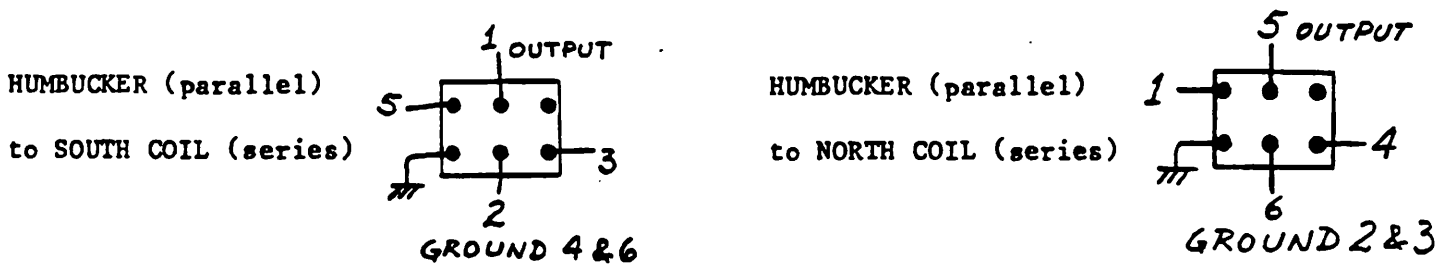

Both sensing coils in parallel will give approximately the same output level as one sensing coil plus the hum cancelling coil in series.

"Music Man" is a registered trademark of Music Man, Inc. Bartolini Guitars is not in any way affiliated with Music Man, Inc.

HUMBUCKER to SINGLE COIL switching (DPDT switches)

HUMBUCKER (series)
to SOUTH COIL (series)

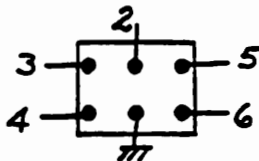

OUTPUT = 1

Both sensing coils in series will give approximately twice the output level of one sensing coil plus the hum cancelling coil in series.

All single coil wirings shown are fully hum cancelled. They sense a very short section of the string giving the highest accuracy and definition to the sound. The humbucker modes sense a very long section of the string giving more emphasis to the lower harmonics and higher output.

All wiring from the pickup to the control cavity of the instrument should be fully shielded. See the accessories section of the price list for multi-conductor cable.

DO NOT TEST COIL RESISTANCE WITH VOLTAGES GREATER THAN 1.5 VOLTS. If in doubt use another voltmeter to test the voltage present at your voltmeter/ohmmeter probes. DO NOT OVERHEAT THE PINS OR THE COPPERFOIL SHIELDING. Use a low wattage (25 watts maximum) or thermostatically controlled soldering iron and good grade electronic solder. Apply the least amount of heat for the shortest time necessary to make a good connection.

DO NOT USE ACID FLUXES OR ACID CORE SOLDER.

Damage to the pickup arising from failure to follow these instructions is not covered by our warranty.

Bartolini pickups are designed and manufactured by
BARTOLINI GUITARS, P.O. Box 934, Livermore, California 94550
U.S. Pat. Nos. 39837777 and 39837778

SINGLE COIL switching (DPDT switches)

SOUTH COIL (series)
to NORTH COIL (series)

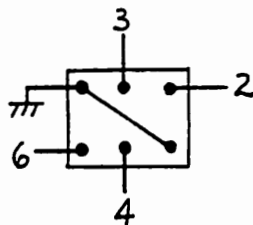

output = 1
link 1 to 5

S coil ←→ N coil
TOGGLE

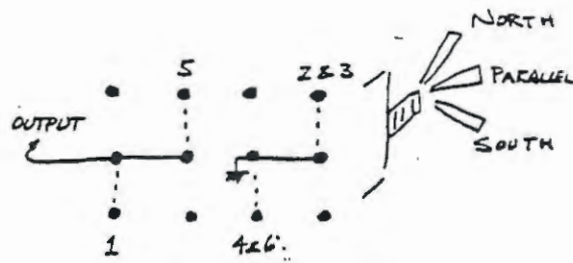
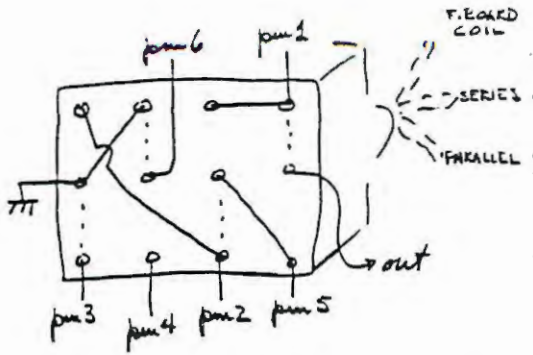

WIRE PINS 2 & 3 TOGETHER
 " * 4 & 6 "

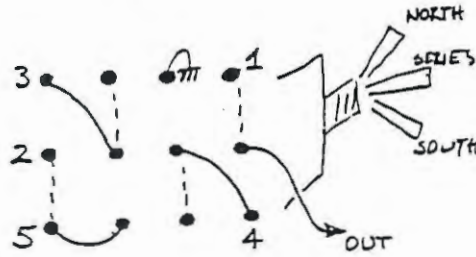
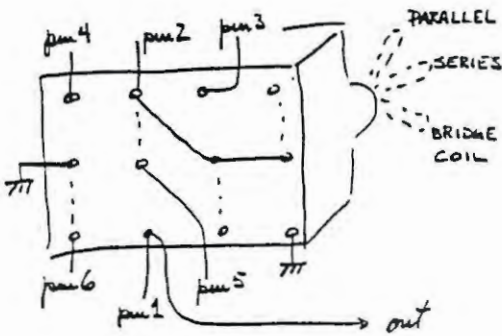

PIN 6 IS GROUNDED.

SWITCH IS 4PDT (ON-ON-ON) ALCO MTA 4067A OR C&K 7411

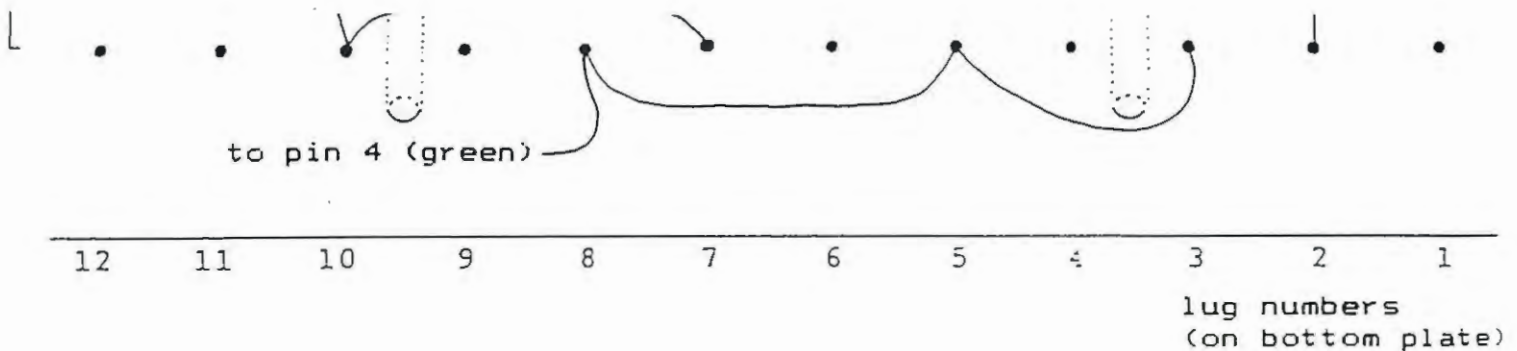

- Position 1: bridge and neck coils in series (humbucker - series)
 fullest tone - maximum output
- 2: neck coil series (hum-cancelled single coil - series)
 output level: 6 dB below Pos. 1
- 3: bridge coil series (hum-cancelled single coil - series)
 output level: 6 dB below Pos. 1
- 4: bridge and neck coils in parallel (humbucker - parallel)
 output level: 6 dB below Pos. 1
- 5: bridge coil parallel (hum-cancelled single coil - parallel)
 brightest tone - least output
 output level: 12 dB below Pos. 1

To omit Position 5 set the locating pin so that only the first four positions are available.

Check the manufacturer instructions on the other side of these instructions before setting the locating pins or wiring the switch.

GRAYHILL
Series 71 ROTARY SWITCH
2 - 6 positions - shorting

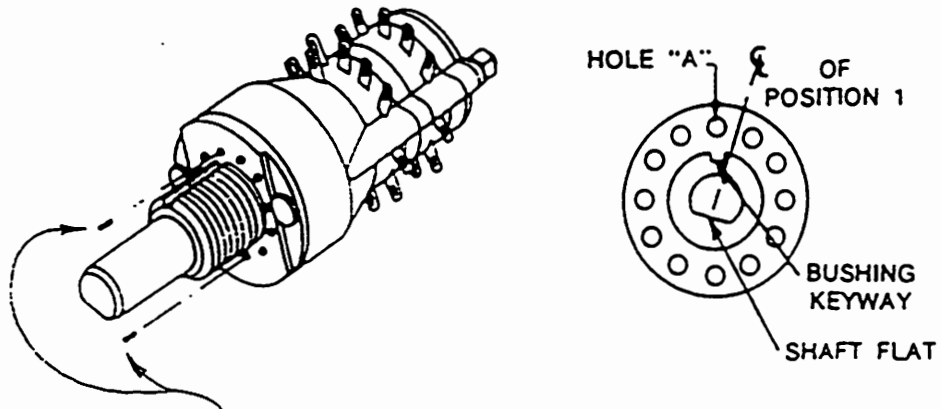

The stop pins are inserted into the front plate of the switch to limit the rotation of the switch. The stop pins are very small and easy to lose. Keep them on an adhesive surface such as masking tape until they are ready to install.

1. Orient the shaft flat as shown and turn one position clockwise.
2. Insert one stop pin in hole "A" to limit counter-clockwise rotation of the switch.
3. Insert the other stop pin in the hole immediately clockwise of the number of positions desired. The switch positions are numbered on the back plate of the switch.
4. The stop pins are hardened steel, they should not be replaced by soft wire which may deform with use and may not be removable if badly deformed.
5. The adhesive washer fits over the bushing and keeps the stop pins from falling out.