









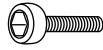

ASSEMBLY INSTRUCTIONS

**ATTENTION: THIS PRODUCT IS NOT FOR COMMERCIAL USE
INTENDED FOR RESIDENTIAL USE ONLY.**

TGS60LC

PARTS LIST

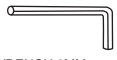
PART NO.	MATERIAL CODE	PART	Q'TY
1	TGS60LC-CS01	 TABLE TOP	1
2	TGS60LC-CS02	 LEG	2
3	62TGS60LCI101	 SUPPORT	2
4	TGS60LC-CS03	 CENTER CONNECTOR	1
5	17C02A0717001Y4	 BOLT M6*50	10
6	17C01A0706002Y4	 BOLT M6*16	8

PART NO.	MATERIAL CODE	PART	Q'TY
7	17C01A0709002Y4	 BOLT M6*25	2
8	17FA05040301-Y4	 WASHER d6.5*D13*1.0	10
9	18000337002	 BOLT CAP M6	10
10	18000337006	 BOLT CAP M6	10
11	17KAA0201----Y4	 HEX KEY WRENCH 6MM	1
12	1422	 TOUCH UP PAINT	1

Attention:

Make sure that each bolt needed for all steps matches the corresponding figure to ensure proper assembly.

Step 1:

Place the table top (#1) onto a non-abrasive surface, such as a carpet, with its underside facing upwards. Fasten the legs (#2) to the underside of the table top (#1) rim by using bolts (#5). Keep the bolts loose. See Figure 1.

Note:

The arrow marks on the legs (#2) should coincide with Figure 1 to ensure proper assembly.

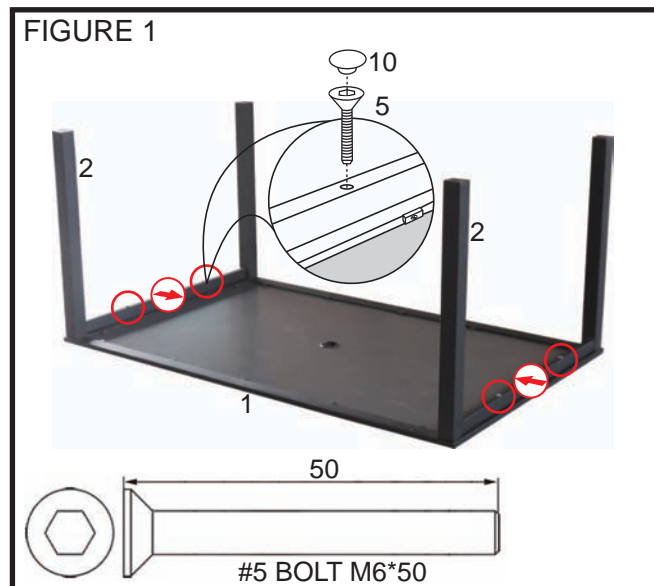







-  Use the correct bolts as indicated. Do not tighten any of the bolts until the table is completely assembled.
-  Do not sit or stand on this table.
-  A weighted umbrella base must be used when using an umbrella with this table.
-  Do not discard any of the packaging until you have checked that you have all of the parts and fittings required.
-  Keep children away during assembly. This item contains small parts that can be swallowed by children. Children should always be under direct adult supervision while using this product.
-  Retain these assembly instructions for future reference.

FIGURE 2



Step 2:
Fasten the supports (#3) to the legs (#2) by using bolts (#6) and washers (#8). Keep the bolts loose. See Figure 2.

- Note:**
1. The arrow marks on the supports (#3) must coincide with Figure 2 to ensure proper assembly.
 2. The tabs on the supports (#3) should be facing inside to ensure proper assembly.

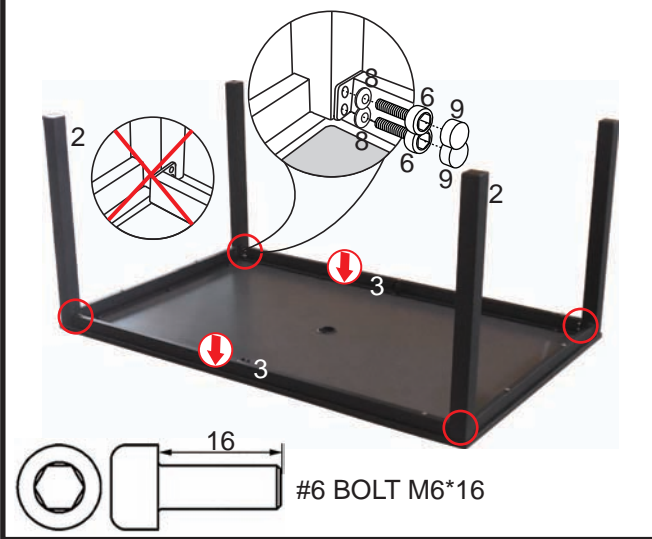
FIGURE 3

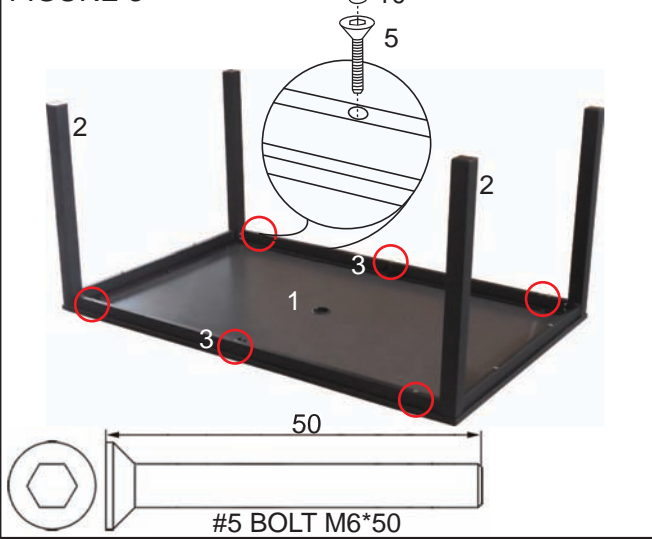

Step 3:
Fasten the supports (#3) to the table top (#1) by using bolts (#5). Keep the bolts loose. See Figure 3.

FIGURE 4

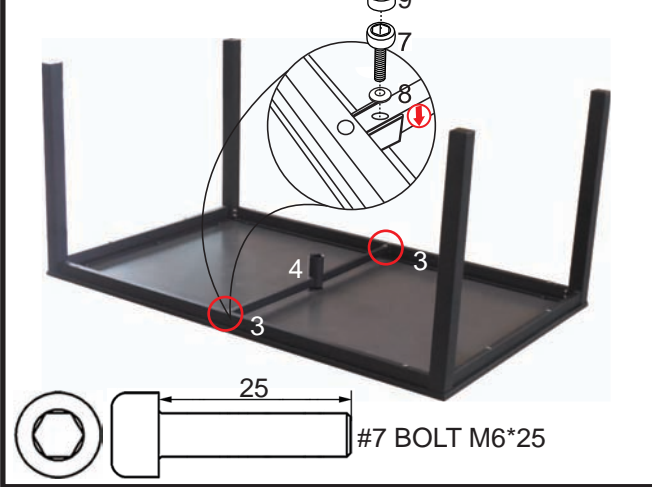

Step 4:
Fasten the center connector (#4) to the supports (#3) by using bolts (#7) and washers (#8). Make sure that all of the bolts have been tightened completely and cover them with bolt caps (#9 and #10). See Figure 4.

FIGURE 5



Step 5:
Turn the table to its upright position. See Figure 5.

- Note:**
1. To use an umbrella with this table, remove the plastic center plug and put the umbrella pole through the table top and center connector ring.
 2. To repair any scratches on the frame, use the touch-up paint (#12) provided.

Cleaning and Maintenance

- Wash frame parts with mild soap and water, rinse thoroughly, and dry completely. Do not use bleach, acid, or other solvents on the frame parts.
- Wash glass with mild soap and water, rinse thoroughly, and dry completely.
- Inspect and tighten all bolts and fasteners on a regular basis to ensure the proper performance and safety of your table.
- When moving the table, remove the umbrella and lift. Do not drag this table.
- We recommend the use of furniture covers when not in use.
- In order to prolong the life and beauty of your table, we recommend that it be stored in a dry and protected area during off season periods.
- Tempered glass has been used for increased strength and safety of your table. However, during windy conditions the umbrella should be lowered and/or removed.