



IS420W
User Manual

Table of Contents

Product Features	2
Safety Precautions.....	4
Package Contents.....	6
Optional Accessories	7
Camera Controls.....	8
Getting Started.....	12
Installing Your Camera.....	14
External GPS Module.....	16
Basic Camera Operation	19
Camera Modes	20
Camera Settings	24
Transferring Files	30
Video Output	30
Firmware Update.....	31
DOD Video Player	31
Specification	32

Product Features



SONY Exmor Sensor- ISO Sensitivity Up to ISO 3200

With SONY Exmor sensor, light sensing capability of ISO 3200, capture night videos just as clear as day time.



1080p FULL HD Video Recording

1080p High-definition video recording & CMOS sensor. No matter day or night, IS420W can perfectly record all the time.



High Speed External GPS Receiver

Record your driving speed and location accurately. Visualize your route on a map with DOD Player (free software)



Advanced WDR Technology - Stunning Videos in Any Light

WDR technology, well-balanced exposure for any condition. It makes night shots brighter; prevent overexposure and to create the clearest image.



DOD GPS Player

The DOD GPS Player generates 1080p video recordings with real-time driving data clearly at a glance.



140° Wide View Angle

Wide angle, wide view, without distortion. The brand-new-designed optical lens captures images with ultra wide fields of view, covering up to 140 degrees, without pincushion or distortion.



f/1.8 Large Aperture Glass Lens - Super Low Light Performance

IS420W possesses the *f/1.8* large aperture, capturing the better night shots than *f/2.0*, and records clearly sophisticated details such as the license plate and others.



6G Sharp Glass Lens

6-Element sharp lens, made up of 6 layers of glass, provides stunning clear and non-deformed images.



G-Sensor Automatic Trigger for File Protection

When an impact, emergency brake occurred or the car tilted, the device will lock the current video files automatically. Important files will not be overwritten by loop recording.



Loop Recording

When the storage space is full, it can automatically overwrite the un-protected files.



Path Analysis

Calculate the distance, time and average speed of your journey from location A to B. It's a very economical and practical way to save your time and fuel consumption.



Parking surveillance

Ensure your peace of mind by recording continually even when you have parked and left your car. Record and lock a file if unusual shock or movement is detected.

**DOD DP4 hardwiring kit required*

Safety Precautions

Product

- Do not disassemble, repair, modify your camera or power related accessories. For warranty service, please contact DOD Tech Support.
- Do not adjust camera while driving.
- Avoid exposing your camera to extended periods of humidity and/or heat.
- Prolonged exposure may reduce the product's lifespan.
- Do not spray water or cleaning agents directly onto the camera.
- Fluids may cause fire, electric shocks, or malfunctions.
- Avoid installing camera where it may obstruct the driver's view or airbag deployment.

Car Power Adaptor

- Use ONLY the power adapter supplied with your unit.
- Other power adapters may create a safety hazard or damage the unit.
- Do not use damaged power adapters or cords. If damaged, please disconnect the power adapter and contact DOD Tech Support for assistance.
- Do not pull, insert, or bend the power cable using excessive force.
- Do not operate or handle power cable with wet hands.
- In specified cars, the power may be constantly supplied to the device even the engine is turned off. This may run out the vehicle battery. The optional DOD DP4 kit equipped with low-voltage protection design to prevent battery drain.

Battery

- Keep the device away from heaters or other hot objects.
- Store the camera at lower temperatures to reduce the rate of self-discharge and preserves the initial energy stored in the battery. The battery in the device self-discharges over a period of time naturally whether the battery is used or not.
- Charge the dash camera for 5 minutes if you are unable to turn on the camera.

Others

- Test the MicroSD memory card regularly as the memory card is a consumable item, and needs to be replaced periodically.
- Reformat the memory card every two weeks to prolong its lifetime. You should only do this AFTER you've download any files from the card that you would like to keep, since formatting the memory card will clear all files.
- DOD does NOT responsible for any malfunctions occurred from the use of disingenuous, modified, or unauthorized parts and accessories.
- DOD does NOT guarantee the recording of accidents which may cause the device malfunction and faulty.
- The working temperature of this product is $-20^{\circ}\text{C}\sim 65^{\circ}\text{C}$ ($-4^{\circ}\text{F}\sim 149^{\circ}\text{F}$). Please ensure the device is stored within the temperature range; or the device may be damaged by the heat and work incorrectly, which will not be covered by warranty.
- DOD is NOT responsible for the loss of any recorded video during operation due to unexpected factors or force majeure when driving.
- The video recordings made by this Dash cam are intended for personal use ONLY.

Package Contents

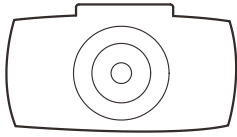

Dash Cam

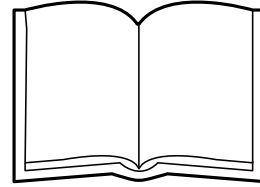

User Guide

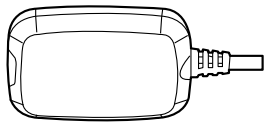

External GPS Module

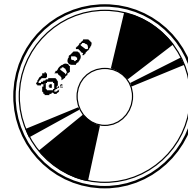

DOD Player Installation CD

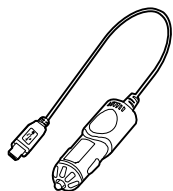

Car Power Adaptor

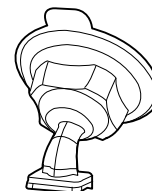

Bracket

Note: Supplied accessories may vary by region.

Optional Accessories

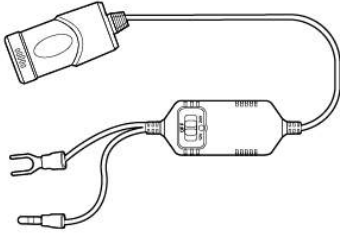

DP4

DP4 hardwiring kit offers constant source and prevent battery drain with low-voltage protection.

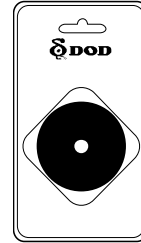

DA2S

DA2S Suction Savior provides a long lasting adhesion to suction cups.

Camera Controls

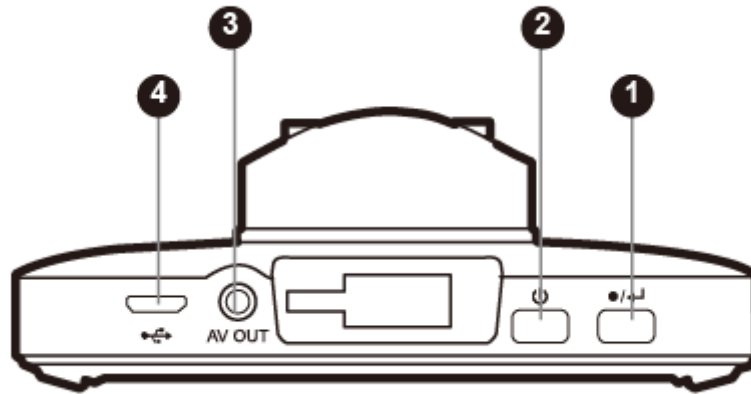

① Record/Shutter/OK [●/←]

Video Mode: Start/Stop recording

Camera Mode: Take a photo

Video Playback Mode: Play / pause Video

Settings Mode: Select highlighted item.

② Power Button ON/OFF [⏻]

Turn on/off the unit.

③ AV Out: A/V Video Output Port

For use with an AV cable to output the video content external display device.

④ USB Port

For use with the supplied Car Power Adaptor or USB data cable.

Camera Controls

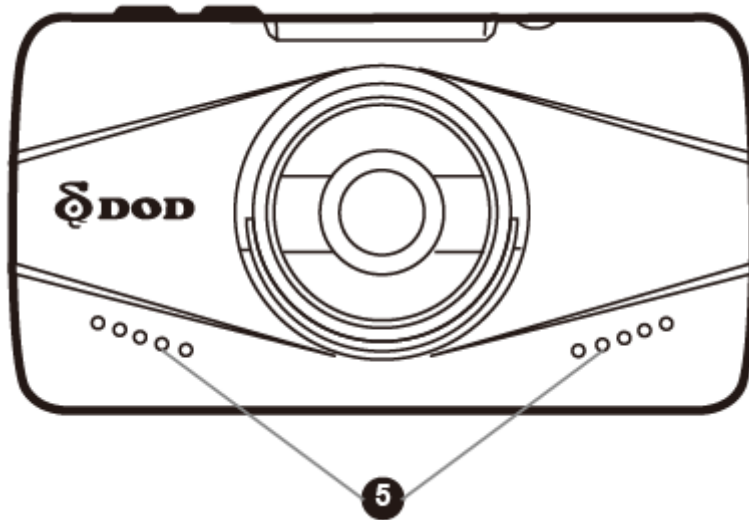

⑤ Speaker

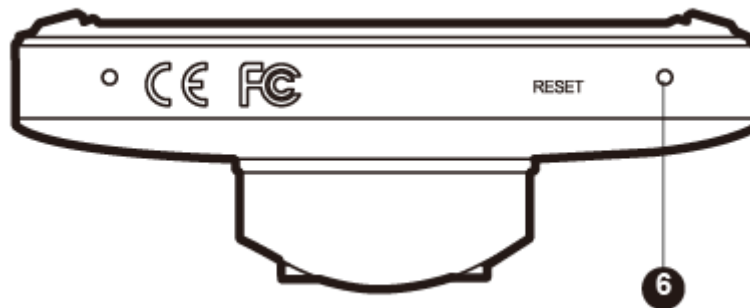

⑥ Reset Button

Reset to factory settings.

Press to force the device to reboot.

Use a small pin to press the button.

Camera Controls

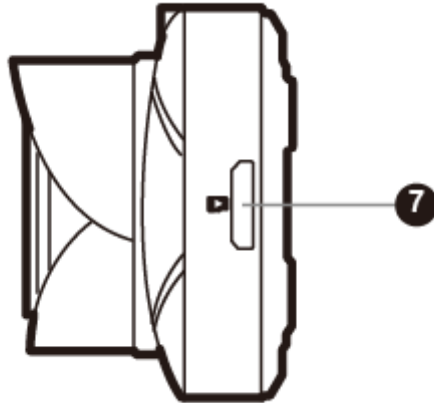

⑦ MicroSD Slot

Required a microSDHC/SDXC card, class 6 or above. Support 8~32GB.



⑧ Arrow Keys [▲/▼]

Used to navigate through menus and select videos for playback.

⑨ Menu/SOS Emergency File Lock [■/▲]

- While recording, this button locks the current file from being over written.
- When recording has stopped, this button will access the settings menu. To stop recording, press the Record/Select button [●/←] .

Camera Controls

⑩ Mode/Mute **[M/🔇]**

- Reset to factory settings.
- While recording, press and hold this button to turn on/off the microphone.
- Change camera modes when not recording videos.

⑪ Operation Status LED

- Steady blue - Unit is powered off and is charging.
- Steady pink - Unit is Standby Mode, Camera Mode or Playback Mode.
- Steady red - Unit is at Standby Mode but not charging.
- Flashing red - Unit is on Recording but not charging.
- Flashing between blue and pink - Unit is on Recording and charging.

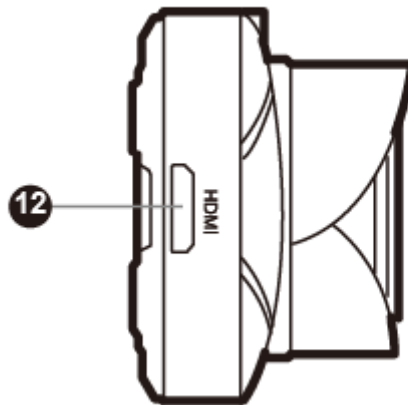

⑫ HDMI Output Slot

Getting Started

Setting Up Your Camera

Set up your camera inside your vehicle to ensure easy access to power.

1. Insert the MicroSD Card.

Format the MicroSD card before initial use.

To save recorded videos stably, DOD Tech recommends formatting your SD card every two weeks.



Note: Requires the MicroSD card up to 32GB

Note: After formatting the SD card, all of your data will be lost. Be sure that you have backed up the important files.

Video Recording Length

Storage/Quality	1080p Recording length	720p Recording length
16GB	140minutes	320minutes
32GB	280 minutes	650minutes

**Video recording length may vary depending on environmental conditions.*

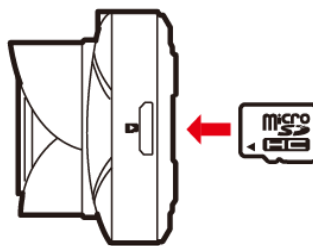

2. Connect the Power Adapter.

Plug the DOD power adapter into your vehicle's power outlet.

Insert the USB plug into the USB port.

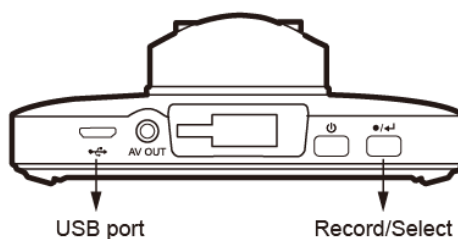

Getting Started

3. Turn on Your Vehicle.

Power from your vehicle through the outlet will automatically turn on your camera and when power is turned off your camera will shut off automatically. The camera automatically begins recording every time it is turned on and stops recording when it is turned off.



Note: In specified cars, the power may be constantly supplied to the device even the engine is turned off. This may run out the vehicle battery. The optional DOD DP4 kit equipped with low-voltage protection design to prevent battery drainage.

4. Turn on/off Your Camera.

Press 【】 to turn on or turn off the unit.

5. Select Language→Set the Time Zone→Select the Speed Unit of Your Choice

Upon powering up the camera for the first time or after upgrading the firmware on the device, you will need to go through the Settings below.

Select Language

- Select the language of your choice by pressing 【▲/▼】.
- Press 【●/←】 found on the top of your unit to confirm your selection.
- Set the time zone
- Scroll down and select your respective time zone.
- Press 【●/←】.
- Your camera will automatically sync with the time and date to the atomic clock once the time zone is correctly set.

Note: The time zone must be manually adjusted for daylight savings.

- Select the speed unit of your choice

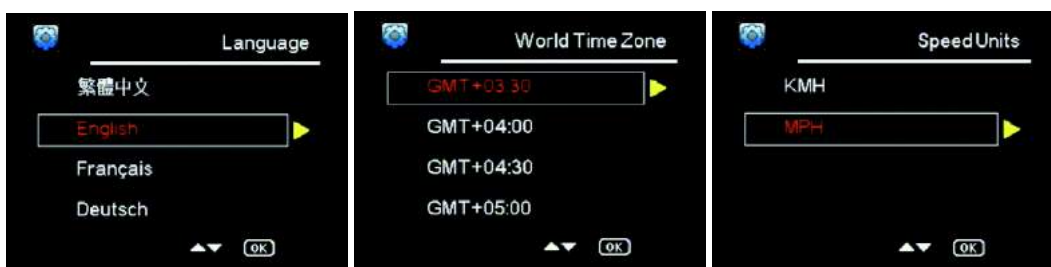

Installing Your Camera

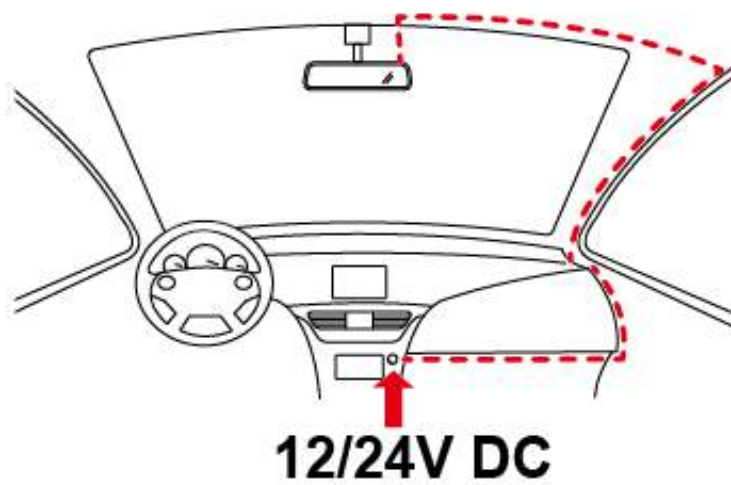
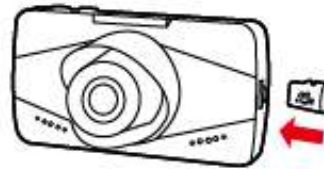

Installing Your Camera

1. Clean Windshield

- Wipe down both the interior and exterior glass for the best image quality.
- Keep the mount secured to the windshield.

2. Attach the Mount to Your Camera

- Keep the mount secured to the camera.
- Please insert MicroSD card to the unit.

3. Prepare the Camera for Installation

- Peel off the protective mount cover.
- Find a location which does not obstruct your view when driving.
- It is recommended to place the camera behind the rear view mirror without obstructing either lenses or camera functions.

4. Adjust the Angle

- The mount has an adjustable ball joint which can be loosened using the plastic locking nut.
- Angle your camera slightly below the horizon line to minimize glare.
- Press the mount firmly against the glass and turn the mount arm to secure the mount.

5. Install the Car Power Adaptor

- If you have not done so previously, plug the car power adaptor into your vehicle's power outlet.
- Insert the USB plug (on top side of the unit) into the USB port on the camera, and insert the power adaptor into the cigarette lighter socket of your car.
- The wiring can be hidden in the headliner, seams and rubber strips around the perimeter of the windshield.
- Remove the protective lens cover.

6. Remove the Lens Protector Film

Your camera is now installed and ready for daily use.



Note:

- *Always use the supplied car power adaptor to avoid the unexpected damage.*
- *If grease, fingerprints, or blots are found on the external/internal windshield of the car, please wipe it clean or install the unit on an unaffected area. Blots may worsen the recording quality or may cause the bracket to be unstable.*
- *Do not turn on Motion Detection unless your vehicle is parked. If Motion Detection is enabled while driving, the camera may not continuously record.*
- *DOD Tech recommends setting the G-Sensor to low.*

External GPS Module

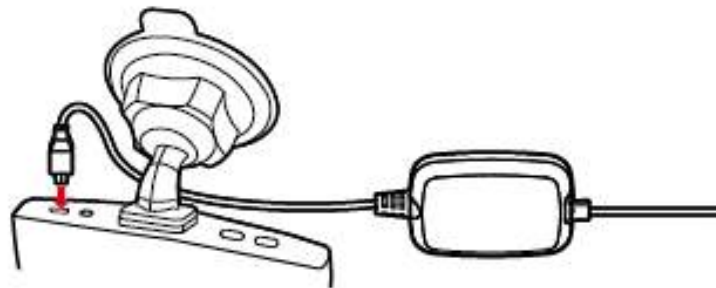

Note: Please point the adhesive side upwards. DOD Tech suggests to place GPS module on windshield for best signal reception.

External GPS Module

Clean Windshield

Wipe down both the interior and exterior glass to ensure firm installation.

Install at Desired Position

- Peel off the protective mount cover.
- Find a location which does not obstruct your view when driving.
- DOD Tech recommends placing the camera behind the rear view mirror without obstructing either lenses or camera functions.

Connect External GPS Module and Power to Dash Cam

Plug in the micro USB connector from external GPS module to dash cam, the GPS module function as power bypass in addition to GPS functions.

1. Turn on Your Vehicle

- In most vehicles, this will send power to the outlet and automatically turn on your camera.
- In some vehicles, the power outlet is continuously powered even when the vehicle is off.

Turn on/off Your Camera

Press [] to turn on or turn off the unit.

2. Adjust the Angle

- The mount has an adjustable ball joint which allows angle adjustment to aim at desired angle.
- DOD Tech suggests to aim your camera slightly below the horizon line for maximum front view.

3. Install the Cigarette Adapter

- If you have not done so previously, plug the cigarette adapter into your vehicle's power port. Insert the USB plug (opposite end of the power) into the USB port on the camera, and insert the power adapter into the cigarette lighter socket of your car.
- The wiring can be hidden in the headliner, seams and rubber strips around the perimeter of the windshield.

4. Remove the Protective Lens Cover

External GPS Module

Your camera is now installed and ready for daily use.

Tips:

- If grease, fingerprints, or blots are found on the external/internal windshield of the car, please wipe it clean or install the unit on an unaffected area. Blots may worsen the recording quality or may cause the bracket to be unstable.
- Do not turn on Motion Detection unless your vehicle is parked. If Motion Detection is enabled while driving, the camera may not continuously record.
- DOD Tech recommends setting the G-Sensor to low.

Basic Camera Operation

Everyday Operation

Your dash camera will automatically turn on and start recording when it starts receiving power. By default, the camera will record over the oldest videos when the memory card is full (loop recording).

Continuously Powered Electrical Outlet

If your camera is continuously powered, the camera will not automatically shut down when your vehicle is turned off. To turn off your camera, the USB cable can be pulled out or the power button can be pressed (see the below section).



The camera may be left on while parked to capture video while you are away. “Continuously-Powered-Electrical-Outlet” operation will slowly drain your vehicle’s battery and may eventually prevent your car from starting.

Manually Turning On/Off Your Camera

- Press **【⏻】** to turn on/off your camera.
- Press **【●/⏪】** to begin recording.

Video Directory:

Videos will be saved in the memory card, normal videos are in the root directory and the protected files will be saved in the “RO” directory.

File-naming format: 2016_0725_180946_002

Year/month/day, time, sequence of the video recorded at the same day.

Camera Modes

When the camera is not recording video, you can switch between three modes by pressing the **[M]** :

1. Video Recording
2. Photo
3. Video Playback







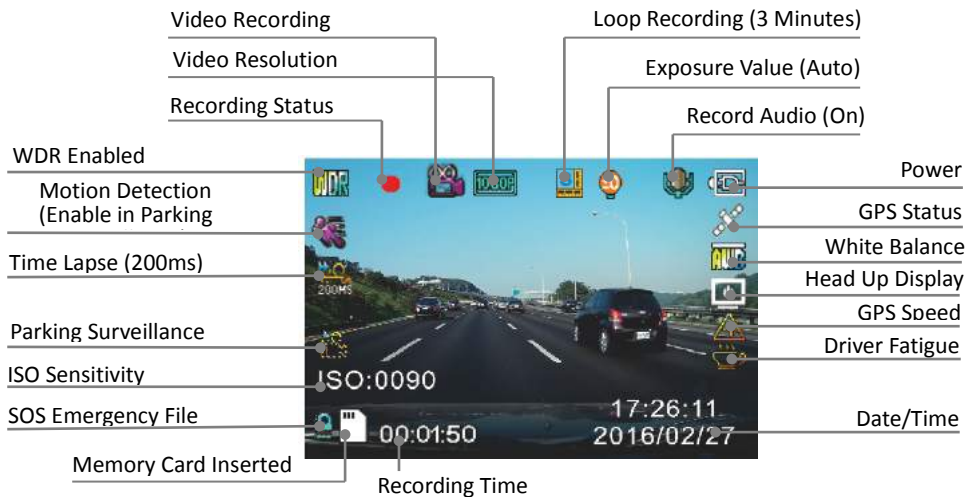













1. Video Recording Mode

The camera defaults to video recording when the camera is first turned on.

- Recording Mode: Press **[●]** to start/stop recording.
- Standby Mode: Press **[M]** to access two Modes: Photo Mode and Playback Mode.



Note: GPS Icon keeps flashing when it has not received the GPS signal. HUD and Speed Warning only work when received the GPS signals.

	WDR	Indicates the WDR function is on.
	Recording Status	Flashes red when recording video.
	Video Recording Mode	Indicates the device is in video mode.
	Resolution	Indicates the current recording resolution.
	Loop Recording	Indicates the current video recording length per file.
	Exposure Value	Indicates the current exposure value setting.
	Audio	Indicates if the audio recording is on or off.
	Power Status	Indicates the power source and the battery status if external power is not connected.
	Motion Detection (Enable in Parking Surveillance)	Indicates if motion detection is on.
	Time Lapse	Indicates the Time Lapse setting.
	Parking Surveillance	Indicates if the Parking Surveillance is on, for details please check page 25.
	ISO Sensitivity	Indicates the current ISO value.
	SOS Emergency File Lock	Appears when a file is locked by G-sensor or by pressing the file lock button.
	Memory Card Inserted	Indicates if a memory card is inserted.
	Time Elapsed	Indicates the length of current recording.
	GPS Status	Flashes whilst the device is searching satellites. Once the positioning is done, the flashing will stop.
	White Balance	Indicates the White Balance setting.
	Head up Display	Indicates if the HUD function is on.
	GPS Speed Warning	Indicates if the GPS speed warning is on.
	Driver Fatigue Warning	Indicates if the driver fatigue function is on.
	Date/Time	Set current time.







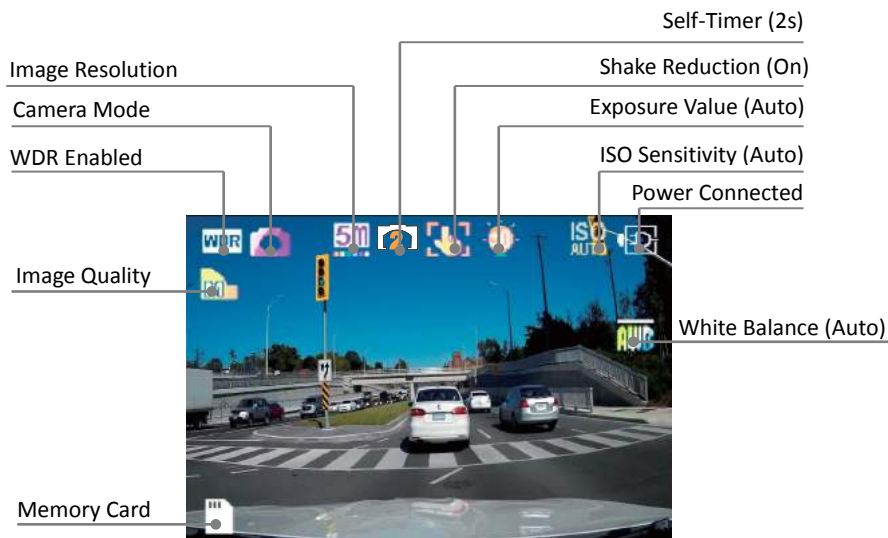

Camera Modes

2.Photo Mode

- Press **【M】** once to enter the Photo Mode during the Standby Mode.
- Press **【●/←】** to take a photo.

Note: Photo Mode is only accessible during the Standby Mode.



	WDR	Indicates the WDR function is on.
	Camera Mode	Indicates the device is in camera mode.
	Resolution	Indicates the current picture resolution.
	Self-Timer	Indicate the self-timer setting.
	Shake Reduction	Indicates if the shake reduction function is on.
	Exposure Value	Indicates the current exposure value setting.
	ISO Sensitivity	Indicates the current ISO value.
	Power Status	Indicates the power source and the battery status if external power is not connected.
	White Balance	Indicates the white balance setting.

Camera Modes

3. Playback Mode

You can watch previously recorded videos in Playback Mode.

Press **[M]** twice to enter the Playback Mode during the Standby Mode.

● Play the Video

- Press **[●/◀]** to play and pause.
- Press **[▲/▼]** to move or back forwards and press **[M]**
- To enter the Playback Mode.

● Delete Files from the card (This cannot be undone).

- Press **[E]** to enter Playback Menu during Playback Mode.
- Press **[▲/▼]** to delete the file and press **[●/◀]** to confirm.

● Protect the current file from being overwritten or erased

- Press **[E]** to enter Playback Menu during Playback Mode.
- Press **[▲/▼]** to lock the file.
- Press **[●/◀]** to confirm. If protected, a blue padlock icon will appear at the top of the screen.
- Press **[E]** to exit.

Note: The "Format" setting will erase all files including locked files.

● Slideshow

- Press the menu button and navigate to slideshow.
- Photos and the first frame of each video will be shown in order.



Camera Settings

Each mode has a unique set of settings. See the description below.

Two Camera Settings pages are accessible:

- Functional Settings
- System Settings

The menu settings can be switched by pressing **【】**.

If you move the cursor before pressing **【】**, you must exit and try again.

*Note: Press **【/←】** to enter the camera settings when recording.*

Video Recording: Functional Settings Page

Accessed by pressing **【】** once.

● **WDR (Wide Dynamic Range)**

Cannot be changed.

Shows WDR processing is enabled.

● **Exposure Value**

Sets the brightness /darkness of the video.

Video too bright? Set between -1 to -3.

Video too dark? +1 to +3.

Recommended setting: 0

● **Record Audio**

Switches the microphone on/off.

Can be used during recording by pressing button **【】**.

● **Loop Recording**

Can be set to 2, 3 or 5 minutes. Video recordings of the selected length will be recorded onto the memory card. When the memory card is full, the oldest files will be overwritten, excluding locked clips. Turning off loop recording will prevent the camera from writing new files when the memory card is filled.

● **Resolution**

Changes the video resolution. Lower the resolution for smaller file sizes but this reduces video quality.

Recommended setting: 1080p FHD.

Camera Settings

● White Balance

Present the true color image under different lighting condition by select Auto/Daylight/Cloudy/Tungsten/Fluorescent

Recommended setting: Auto.

● Date Stamp

Imprints the time and date on the recorded video.

● G -Sensor

Measures shock forces. The settings from “low to high” determine the amount of force needed to lock the file from being overwritten. Once the function is triggered, the current recording video will be locked and the file will be saved in the “RO” directory.

Recommended setting: low.

Functional Settings (Video recording mode)

Accessed by pressing **[F1]** once.

● Parking Surveillance (Default: Off)

When function is enabled, dashboard camera will automatically switch to Parking Surveillance if vehicle is stationary for over 10 minutes.

1. Automatically records a 15-second video when motion detected within view range of camera.
2. Automatically records and locks a 1-minute video when excessive force of impact is detected by G-sensor.
3. Unit will return to normal recording mode if vehicle moves continuously for 3 seconds or longer.



Note:

Parking Surveillance requires consistent power supply via vehicle battery. (It is recommended to use optional DOD DP4 kit equipped with low-voltage protection design to prevent battery drainage.)

Please ensure to enable G-sensor function in setting menu before switch to Parking Surveillance. (G-sensor sensitivity Default: Medium)

Parking Surveillance will automatically shut down GPS locating, and will resume when switched to normal recording mode.

Camera Settings

● Plate Stamp

Imprints a customized set of 8 digits to the recorded video. Add license plates or other identifying features to watermark your video.

● GPS Logging

- On/Off.
- Default: On.

● Set Time Zone

Sets the current time zone for GPS time and date calibration. Not the time zone must be manually adjusted for daylight savings

● Speed Units

Select metric or imperial units.

● Driver Fatigue Warning

Sets a timed delay before showing a visible alert reminding the driver to take a break.

● Speed Warning

Shows a visual warning on the head-up display when the set speed has been exceeded.

● Password Settings

Set a password lock which will prevent files from being deleted or the settings changed on the device.

Note: This does not prevent other users from extracting the memory card or changing the files. This feature should be turned off during regular driving.

● Image Rotation

Rotates the recorded image 180° when dash cam is mounted on the dashboard instead of windshield.

Camera Settings

Functional Settings (video recording mode)

Accessed by pressing **[≡]** once.

● Time-Lapse

The time-lapse function is used to create a sped-up video. When set, the camera will record one frame every 200ms (milliseconds)/500ms/1 second/5 seconds.

● Head Up Display

After a customized period of time a new screen will appear showing speed and direction. If enabled, the GPS speed warning will appear on this screen.

● Path Analysis

Calculates the total distance, travel time, and average speed of your journey from the beginning of your trip to the end (when camera is turned on to when turned off). If Path Analysis is set to “on”, the results will be displayed when the unit is turned off.

The default setting is “off”.

● ISO Stamp

- On/Off
- Default: On.

Camera Settings

Functional Settings (photo mode)

Accessed in “Photo Mode”.

- **WDR (Wide Dynamic Range)**

Cannot be changed. Shows WDR processing is enabled.

- **Color**

Apply a color filter to the photo.

- **Capture Mode**

Sets a timed delay before taking a photo.

- **ISO**

Change the ISO settings. Higher ISO reduces motion blur at night but lowers video quality.

- **Date Stamp**

Imprints the date at the captured photo.

- **Image Size**

Adjusts the size of the image. Higher megapixels increase file size and details.

- **Anti-Shaking**

Helps reduce the effects of shaking when taking a photo.

- **White Balance**

Present the true color image under different lighting conditions by select Auto/Daylight/Cloudy/Tungsten/Fluorescent.

Recommended setting: Auto.

- **Exposure Value**

Sets the brightness/darkness of the video.

Photo too bright?

Set between -1 to -3.

Photo too dark? +1 to +3.

Recommended setting: 0.

Camera Settings

System Settings

Accessed by pressing **[]** twice.

- **Format**

Completely deletes all files including locked footage on the memory card and optimizes the card for recording.

- **Date/Time**

Sets year/date/time format.

- **Beep Sound**

Turns on/off notification sounds.

- **TV Mode**

Switches between the NTSC and PAL video output standard.

- **Default Settings**

Sets all settings back to the original settings.

- **Language**

Sets the language.

- **Frequency**

Adjusts the camera's frequency setting to minimize flickering and banding in the recorded video.

- **Screen Saver**

Turns off the screen after the set time.

- **Version**

Shows the model name and current firmware version.

Transferring Files

Video files can be transferred to your electronic device for viewing and storage.

USB Cable

1. Connect a USB cable from the camera's USB port to computer.
2. Turn on your camera. A black screen should appear showing "Mass Storage".
3. Press the **【●/←】** button. A blue screen should appear labeled "Mass Storage".
4. Your computer should now detect a new device. The memory card and videos can be accessed similar to a USB flash drive.

Card Reader/MicroSD Slot

Use a memory card reader (separately purchased) or a compatible electronic device with a MicroSD slot (ex: tablet). Follow the manufacturer's instructions.

Video Output

Choose one of the methods below to install the output connection.

HDMI (TV)

Connecting a mini-HDMI to HDMI from your camera to a compatible television/monitor will automatically output the camera's screen. Recording functions are disabled while streaming video.

AV Port

Using a 2.5mm AV cable, plug the 2.5mm connector into the camera's AV port. Plug the RCA end into a compatible port on your television or monitor.

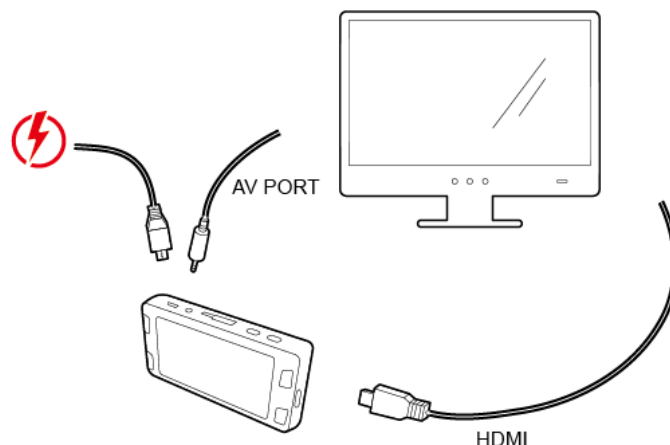

Firmware Update

See the support section on DOD Tech's website for any available firmware updates and instructions.

DOD Video Player



Specification

Video Resolution	1920x1080@30fps 1280X720@60fps 1280X720@30fps
Sensor	SONY Exmor CMOS sensor
Wide-Angle Lens	140°
Aperture	<i>f</i> /1.8
ISO Sensitivity	up to ISO 3200
Display	2.7" 16:9 TFT LCD
Video Format	H.264 MOV
Recording Media	micro SDHC/SDXC Card (Up to 32GB)
Audio	Mic and Speaker(Mono)Equipped
Battery	3.7V 140mAh Lithium-ion Battery
Power Input	5V 1.5A
Size	85.5 (L) x 46(W) x 39.5 (H)mm
Weight	65g (0.14lbs)
Operating Temperature	-20°C ~65°C

Copyright ©2016 DOD Tech

All Rights Reserved

Under the copyright laws, this manual may not be copied,
in any way, shape, or form, without the written consent of DOD Tech.