

BMW X5



The Ultimate Driving Machine

www.bmw.co.za



THE BMW X5.

BMW EFFICIENT DYNAMICS.
LESS CONSUMPTION. MORE DRIVING PLEASURE.

**THE NEXT
100 YEARS**







The BMW X5

MASTER OF MULTI-TASKING.

- 06 Exterior**
Perfectly poised for every journey.
- 12 Driving dynamics**
Adaptive suspension packages, the BMW xDrive intelligent four-wheel drive system.
- 14 Cockpit**
Intuitive and intelligent.
- 16 Aerodynamics**
Setting new standards.
- 18 Interior**
Exclusive atmosphere.
- 20 The BMW X5 xDrive40e iPerformance¹**
Electrifying drive concept: BMW eDrive.

Technology

INNOVATIONS THAT SET TRENDS.

- 22 BMW ConnectedDrive**
So connected, you're free.
- 26 BMW EfficientDynamics**
Technology package for reduced fuel consumption and emissions.
- 28 BMW TwinPower Turbo engines**
Maximum performance from minimum fuel consumption.
- 30 The BMW X5 xDrive40e plug-in hybrid**
- 32 M Performance**
M Gene included.
- 34 Suspension and safety**
Innovations for greater pleasure.

Equipment

AS INDIVIDUAL AS YOU ARE.

- 38 BMW X5**
- 40 Pure Experience design**
- 42 Pure Excellence design**
- 44 M Sport package**
- 46 BMW Individual**
- 48 Colours, upholstery and interior trims**
- 52 Standard / Optional equipment**
- 63 Original BMW Accessories**

Overview

THE VERSATILITY OF THE BMW X5 AT A GLANCE.

- 64 Technical data and information on fuel consumption and CO₂ emissions**
- 66 BMW Service**
BMW Service, BMW Financial Services and BMW Experience.

Editorial

DESIGNED TO OUTDO ITSELF. YET AGAIN.

Since its launch, the BMW X5 has been setting milestones in its class – a class of which it was the founding member. And now it's back: The third generation X5 has again surpassed its own benchmarks – as a Sports Activity Vehicle (SAV) that delivers outstanding luxury and unparalleled comfort in every regard and never fails to exceed expectations.

It features a huge array of intelligent technologies that take efficiency and dynamism (not to mention comfort and safety) to a whole new level – even when it goes off-road. The BMW X5's superiority is also evident in its two design worlds– Pure Experience and Pure Excellence. No matter whether you want to make a powerful impression, or prefer a look of understated sophistication, there are plenty of design options for expressing your own personal style through the exterior and luxurious interior. The striking curves on the BMW X5 signify a personality that never fails to announce its one overriding attribute: supremacy.

www.bmw.com/X5

Further information on fuel consumption and CO₂ emissions can be found on pages 64/65.

**Specifications of model shown:
BMW X5 xDrive50i with the Pure Experience exterior design
and Pure Excellence interior design.**

Engine:	BMW TwinPower Turbo eight-cylinder petrol engine	Exterior colour:	Sparkling Brown metallic
Power output:	330kW (450hp)	Upholstery:	Exclusive extended Nappa leather Ivory White
Wheels:	19" light alloy wheels Star-spoke style 449	Interior trim:	American Oak fine-wood trim

**Equipment of model shown:
BMW X5 xDrive40e iPerformance with exterior design Pure Excellence
and interior design Pure Excellence.**

Engine:	BMW TwinPower Turbo 4-cylinder petrol engine	Exterior colour:	Glacier Silver metallic
Power output:	180kW (245hp)	Upholstery:	Exclusive extended Nappa leather Ivory White
System output:	230 kW (313 hp)	Interior trim:	Piano finish Black
Wheels:	19" light alloy wheels Star-spoke style 490, BMW EfficientDynamics		



In 2016 the BMW brand will be celebrating its 100th anniversary. Find out more at www.next100.bmw



¹ Planned availability of iPerformance equipment: December 2016.

TRUE LUXURY
& A POWERFUL
PERSONALITY.





THE ULTIMATE ALL-ROUNDER.

Every day presents different challenges. Luckily, the BMW X5 has what it takes to tackle just about anything: versatility. Its two-part tailgate provides easy access to smaller items of luggage and the lower section opens up to create a platform capable of supporting up to 250 kg. The rear seat backrest can be reclined in a 40:20:40 split and when it's completely folded down the luggage compartment capacity is increased to a massive 1,870 litres. The optional third row of seats can accommodate two additional passengers, so there's room for up to seven people. In short: the BMW X5 has a clever solution for whatever challenge comes its way.

Just as impressive as the BMW X5 is the latest incarnation of the iconic BMW R 1200 GS travel enduro motorcycle. Tough, dynamic and unmistakable – this machine's innovative design and cutting-edge technologies make it the most reliable companion for biking adventures on all kinds of terrain.



The very first moment you come face-to-face with the BMW X5, your eyes will be instinctively drawn to its compelling design. Its expressive front with optional Adaptive LED Headlights and the athletic side contours generate a masculine look that's beyond compare. No matter when and where you encounter the BMW X5, one thing is certain – its exclusive appearance will take your breath away.

REIGN SUPREME.





RULES THE ROAD.
AND YOUR HEART.

All the expectations aroused by the masterly presence of the BMW X5 will be confirmed and surpassed when you see it in action. From supremely sporty to comfortable, the optional adaptive suspension packages ensure optimal roadholding for every style of driving. When combined with the intelligent BMW xDrive four-wheel drive system, the X5 delivers an unforgettable driving experience regardless of the road surface or weather conditions, all while providing outstanding safety and the ultimate in driving pleasure. And it doesn't matter which direction you're headed, as the BMW X5 knows one way to go: its own.



In the cockpit of the BMW X5, this is easier than ever: all the controls, such as the optional iDrive Touch Controller, are fully geared towards the driver and the overall clarity of the design is a pleasure to behold. The various BMW ConnectedDrive assistance systems are also clearly focused on one overriding goal: your comfort and safety. Should you find yourself stuck in a traffic jam, for instance, the optional Traffic-queue assistant assumes control of the vehicle, automatically moving forward, maintaining a safe distance to the car in front and steering. After all, sometimes you just need to sit back and relax to really take charge.

SIT DOWN AND
RISE ABOVE IT ALL.

EVEN BLOWS THE WIND AWAY.

Air resistance is no match for the sophisticated aerodynamics of the BMW X5. The car's designers came up with innovative features that greatly improve the air flow. For example, wind turbulence at the front wheel arches is greatly reduced thanks to the Air Curtain on the front apron and the Air Breather at the front wheel arches. Aerodynamically enhanced exterior mirrors and the aeroblade on the rear also play a role in delivering the lowest drag coefficient (C_d value) in its class.





When you take a seat in the BMW X5, one thing becomes instantly clear: perfection is the culmination of an unerring attention to detail. Prepare to be awed by the overall sense of spaciousness in the BMW X5, which is also available with an optional third row of seats, and the meticulously selected premium materials and excellent craftsmanship. Opulence has found a new home: where the aroma of exquisite leather meets the sensory pleasure of fine woods and elegant trims. Combined with the striking atmosphere generated by the ambient lighting design, you'll enjoy an ambience of supreme exclusivity. And the optional Bang & Olufsen High End Surround Sound System takes perfection to a whole new level. The BMW X5 offers a feast for the senses, no matter where you decide to sit.

ENJOY THAT FRONT-ROW FEELING –
NO MATTER WHERE YOU SIT.



POWER, UNITED.

As a plug-in hybrid model, the BMW X5 xDrive40e iPerformance¹ affords equal prominence to athletic design and sustainability. Its intelligent drive concept combines a BMW TwinPower 4-cylinder petrol engine with BMW eDrive components: The interplay between the electric motor, high-voltage lithium-ion battery and intelligent energy management ensures efficient driving pleasure which produces zero local emissions when powered exclusively by electricity. The intelligent BMW xDrive all-wheel drive continuously provides the optimal traction and agility, even when driven in the electric mode. To ensure that it's always fully powered-up, conveniently charge your BMW at home with the charging cable provided via any domestic power socket or using your very own BMW i Wallbox. And while on the go, public charging stations allow you to quickly fill it up with new energy. Experience a whole new dimension in the fusion of breathtaking dynamics and ultimate efficiency – in the BMW X5 with eDrive.

¹ Planned availability of iPerformance equipment: December 2016.



BMW ConnectedDrive

So connected, you're free.

Our world is becoming more closely connected every day. BMW drivers are used to the fact that their vehicle and their world are connected – that they can request information, communicate via telephone or email and always be up to date while they're on the go. The BMW ConnectedDrive concept encompasses all the services and innovative technologies that network BMW vehicles and their passengers with the world outside and the traffic around.



BMW ConnectedDrive encompasses a wide range of intelligent services and assistance systems, allowing everybody to choose just what they need. The BMW ConnectedDrive Services & Apps provide greater flexibility by networking the driver, car and the outside world. The BMW ConnectedDrive driver assistance systems make every drive in a BMW both safer and more convenient. Intelligent systems make the driver's job easier and minimise the risk of accidents.

More information is available at

➔ www.bmw.com/ConnectedDrive

CONNECTED DRIVE SERVICES.

The equipment option **ConnectedDrive Services***¹ forms the basis for BMW ConnectedDrive functions, which provide the driver with a wide range of information, entertainment and service features while on the road.

The offer includes access to current location-based information such as weather and news, as well as an online search powered by Google™ and practical office functions. Services and features such as parking information, as well as travel and hotel guides can be accessed directly in the car without a smartphone via the ConnectedDrive menu.



The secure and comfortable use of selected smartphone applications is also included for an unlimited period of time. The ConnectedDrive Services option also includes access to the **BMW ConnectedDrive Store**, in which services and apps can be booked, extended and selected according to individual needs, at any time and from any place. The ConnectedDrive Services option also offers much more to make each journey in a BMW into a real experience.

* May not be available in all countries, please consult your BMW partner.

¹ For further information on BMW ConnectedDrive, please visit www.bmw.com/connecteddrive

Image shows features that are only available for the German market.

BMW CONNECTED DRIVE SERVICES & APPS – INTELLIGENT CONNECTIVITY.

The **BMW ConnectedDrive Services & Apps*** – configuring them according to your individual needs is now quicker and easier than ever before. Want to listen to your favourite music on every journey? No problem with Online Entertainment.



ONLINE ENTERTAINMENT – MUSIC, WHEREVER YOU GO.

With Online Entertainment, a flat-rate account can be opened with any BMW music partner, such as Napster or Deezer, which can also be used with any other device supported by the provider.*¹ That means unlimited access to over 30 million songs. The Navigation System Professional in conjunction with ConnectedDrive Services is required for use.



INTERNET – INFORMATION AT YOUR FINGERTIPS.

Whether you need to check the balance in your bank account, place a bid on eBay or look something up in Wikipedia, the BMW ConnectedDrive Internet option ensures that you can do whatever you need to do online. To enable you to surf to your heart's content, the iDrive Controller in the centre console doubles as a computer mouse.



BLUETOOTH OFFICE – ALWAYS IN TOUCH.

Bluetooth Office enables BMW office functions such as emails, appointments, tasks, contacts and text messages to be shown on the Control Display or read aloud over the audio speakers using the read-aloud function. All compatible mobile end devices are listed at www.bmw.com/bluetooth.

BMW CONNECTED DRIVE DRIVER ASSISTANCE – A CO-PILOT YOU CAN COUNT ON.

BMW ConnectedDrive driver assistance comprises a host of innovative functions for greater safety and convenience, which make every trip even more enjoyable. Want to know where your next turn is? The full-colour BMW Head-Up Display has the answer. Improved safety in the dark? BMW Night Vision takes care of it.



BMW HEAD-UP DISPLAY² – KEEP YOUR FOCUS ON THE ROAD.

The optional full-colour BMW Head-Up Display projects information relevant to the journey directly into the driver's field of vision, thereby allowing them to fully concentrate on driving. The display includes information such as the current speed, navigation directions, Speed Limit Info incl. no-overtaking indicator, along with telephone and entertainment lists.



TRAFFIC JAM ASSISTANT* – RELAX AND LEAVE THE ROAD TO YOUR BMW.

The Traffic jam assistant eases the burden on the driver during monotonous driving situations on the motorway. At speeds of up to 60 km/h, the system lets the car simply "glide along" with the other cars in dense traffic situations, making traffic jams less stressful. It automatically maintains the distance from the vehicle ahead and regulates the car's speed down to a standstill – as well as providing steering support. This system is only available in conjunction with the optional Driving Assistant Plus package.



BMW NIGHT VISION – THE BENEFIT OF FORESIGHT.

An optional infrared camera in the double kidney grille detects people and animals up to a distance of 300 metres, displaying images on the Control Display. Pedestrian recognition also gives a visual warning to indicate if people are moving close to the road, up to a distance of 100 metres ahead. This means that the driver can recognise potential danger significantly earlier and react more quickly. The new Acute Warning system helps in imminently critical situations, thereby offering even greater safety.

The images shown here merely serve as examples, as the systems are different in each model. The Control Display and the way content is displayed may vary depending on the model.

² Display readability is reduced when wearing polarized sunglasses. The exact content shown on the BMW Head-Up Display will depend on the equipment options chosen. Further optional equipment is required for content to be displayed.

* May not be available in all countries. Please consult your BMW partner.
¹ May vary by country.

▶ **BMW EFFICIENT DYNAMICS.**
LESS EMISSIONS. MORE DRIVING PLEASURE. ◀



BMW EFFICIENT DYNAMICS – MAKING A LITTLE GO A LONG WAY.

At BMW, our focus is always firmly fixed on delivering quintessential BMW “driving pleasure”. To achieve this goal, the pioneering BMW EfficientDynamics strategy is rigorously implemented in all vehicles. This strategy involves the deployment of innovative technologies aimed at both minimising the car’s fuel consumption and emissions while simultaneously maximising the dynamism and exhilarating ride it delivers.

It is a comprehensive technology package that includes the drive system, energy management and the vehicle concept – and is standard in every BMW. The latest generation of the BMW TwinPower Turbo engine family is responsible for reducing emissions and increasing driving pleasure – in both petrol and diesel-powered cars. Optimised aerodynamics and BMW EfficientLightweight both make a huge contribution to boosting efficiency. Intelligent lightweight construction at BMW means using the right material at the right place, resulting not only in a low weight, but also in the ultimate in rigidity and agility.

This is a powerful testament to the innovative leadership of BMW, which is also the only mass-production manufacturer to use ultralight, high-strength carbon (CFRP) in its vehicles. BMW also focuses on pioneering drive concepts, such as BMW eDrive technology with a 100% electric drive, as well as plug-in hybrids.

Overall, the technology package comprises a myriad of systems in every BMW. Features and equipment such as ECO PRO mode, the Automatic Start/Stop function, 8-speed Steptronic transmission and Brake Energy Regeneration are also deployed with the express purpose of lowering fuel consumption and reducing CO₂ emissions, but while simultaneously boosting performance and driving pleasure. All this as standard in every BMW X5 (Steptronic Sport transmission standard with the X5 M50d).

THE BMW EFFICIENT DYNAMICS FEATURES IN THE BMW X5 AT A GLANCE.

In a plug-in hybrid model such as the BMW X5 xDrive40e iPerformance¹, **BMW eDrive** technology delivers the best of both worlds: purely electric, locally emissions-free driving – in towns and cities, for instance – and dynamic driving with a long range. Intelligent energy management regulates the interplay between the electric motor and the engine, deploying both with impressive efficiency.

Intelligent lightweight construction at BMW means using the right material for the right parts of the car. For every single component, the most suitable material is selected; every material has specific qualities that must be considered. The **BMW EfficientLightweight** philosophy is now integral to BMW EfficientDynamics and applied to every BMW. Various materials such as aluminium, high-tensile steel, magnesium and the most high-tech of plastics all contribute to the massive, targeted reduction in vehicle weight, while at the same time increasing vehicle stability. The results can be experienced on any drive in a BMW: faster acceleration, improved agility, greater driving dynamics, optimised road holding, as well as lowered fuel consumption, in combination with increased passive safety thanks to maximum rigidity and strength.

Aerodynamics. Thanks to a range of optimised aerodynamic elements, the BMW X5 xDrive30d delivers an excellent drag coefficient (C_d value) of 0.31. This in turn has a positive effect on overall efficiency and fuel consumption. These elements include air vent control, the Air Curtain in the front apron, the Air Breather in the front wheel arches, as well as the combination of an active rear spoiler and aeroblade.

The **8-speed Steptronic transmission** makes changing gears and driving significantly more convenient, thanks to fast engine speed transitions and shorter shift times. It unites outstanding comfort with palpable dynamics and increased fuel efficiency.

The **ECO PRO mode** helps drivers reduce their fuel consumption by up to 20 percent, depending on their driving style – according to an internal BMW fuel consumption study. Additional functions such as coasting, Route-ahead assistant and ECO PRO route have the potential for an additional five percent reduction in consumption. The coasting function decouples the drivetrain from the engine and the vehicle rolls without additional power input. The car “coasts” when the driver takes their foot off the accelerator between 50 and 160 km/h and does not apply the brakes. Based on data from the navigation system, the Route-ahead assistant recognises bends, built-up areas, speed limits and motorway exits, and gives the driver advance tips when to stop accelerating. ECO PRO route shows the most efficient route based on the traffic situation, driving style and road conditions. The on-board computer displays the percentage of fuel that can be saved by driving along the route selected by ECO PRO route.

BMW BluePerformance technology reduces the nitric oxide (NO_x) generated by diesel engines to a minimum. It has no impact on the actual combustion process and does not adversely affect the diesel engine’s high degree of efficiency.

The **Automatic Start/Stop function** switches off the engine when the vehicle comes to a temporary standstill (e.g. at traffic lights or in a traffic jam) to further reduce overall fuel consumption. When the driver presses down on the clutch (manual transmission) or takes their foot off the brake (Steptronic transmission), the engine automatically starts up again in a fraction of a second.

¹ Planned availability of iPerformance equipment: December 2016.

PEAK PERFORMANCE UNDER PRESSURE. BMW TWIN POWER TURBO TECHNOLOGY.

BMW TwinPower Turbo. The innovative BMW TwinPower Turbo petrol engines are among the core elements of the BMW EfficientDynamics strategy and have already been honoured with numerous awards. They combine the latest fuel injection systems with fully variable power distribution and innovative turbo charger technology.

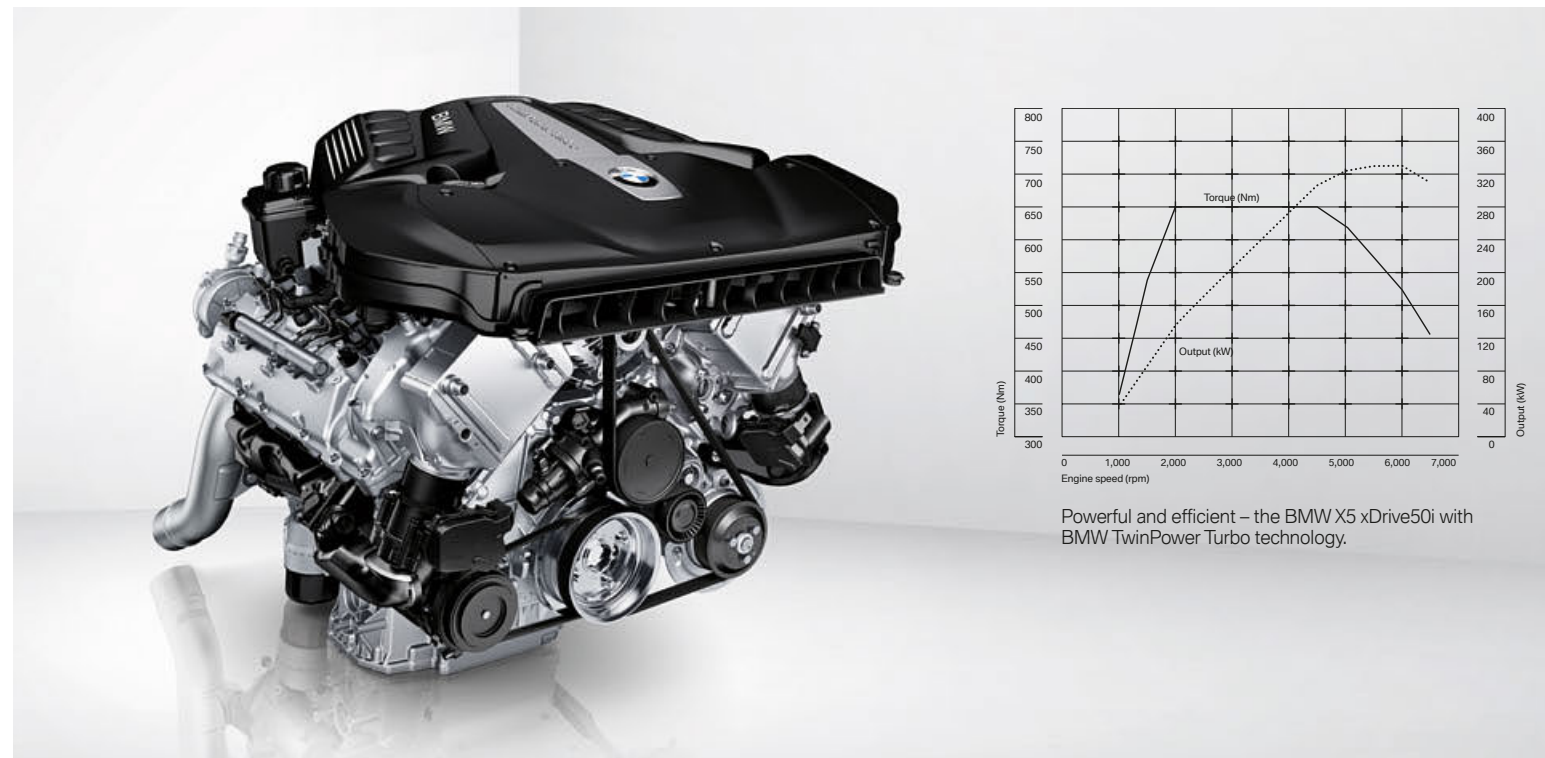

BMW X5 xDrive35i.

The BMW TwinPower Turbo six-cylinder in-line petrol engine combines a TwinScroll turbocharger with Valvetronic, Double-VANOS and High Precision Injection. Responsive acceleration, smooth running and a torque of 400 Nm are the defining hallmarks of this power house, which delivers an output of 225 kW (306 hp) and takes just 6.5 seconds to sprint from 0 to 100 km. This intelligent package of technologies significantly reduces average fuel consumption to 8.5 l/100 km¹ with CO₂ emissions of 197–199 g/km¹.

BMW X5 xDrive40e iPerformance².

With an output of 230 kW (313 hp), the BMW X5 xDrive40e iPerformance² combines the efficient eDrive hybrid drive with the BMW xDrive all-wheel drive system, while also delivering the utmost in traction and agility – even when running in pure electric mode. The drive's key components consist of a 180 kW (245 hp) 4-cylinder petrol engine with BMW TwinPower Turbo technology, an 83 kW (113 hp) electric motor³ along with the variable BMW xDrive all-wheel drive.

BMW X5 xDrive50i.

The BMW TwinPower Turbo V8 engine combines two turbochargers with Valvetronic, including Double-VANOS and High Precision Injection. The result is a massive maximum torque of 650 Nm at engine speeds of between 2000–4500 rpm. With an output of 330 kW (450 hp), it can accelerate from 0 to 100 km/h in an incredible 4.9 seconds. And High Precision Injection ensures extremely efficient fuel consumption.

¹ Fuel consumption and CO₂ emission figures are dependent on tyre format and selected special equipment (higher figures refer to models with optional wheels). Further information on fuel consumption and CO₂ emissions can be found on pages 64 | 65.

² Planned availability of iPerformance equipment: December 2016.

³ Top performance of the electric synchronous motor.

BMW TwinPower Turbo. In diesel engines, BMW TwinPower Turbo technology includes state-of-the-art fuel injection technologies for enhanced efficiency, as well as fully variable power distribution and innovative turbocharging technology for a more dynamic ride. All diesel models feature lightweight aluminium construction and are equipped with a zero-maintenance particle filter.

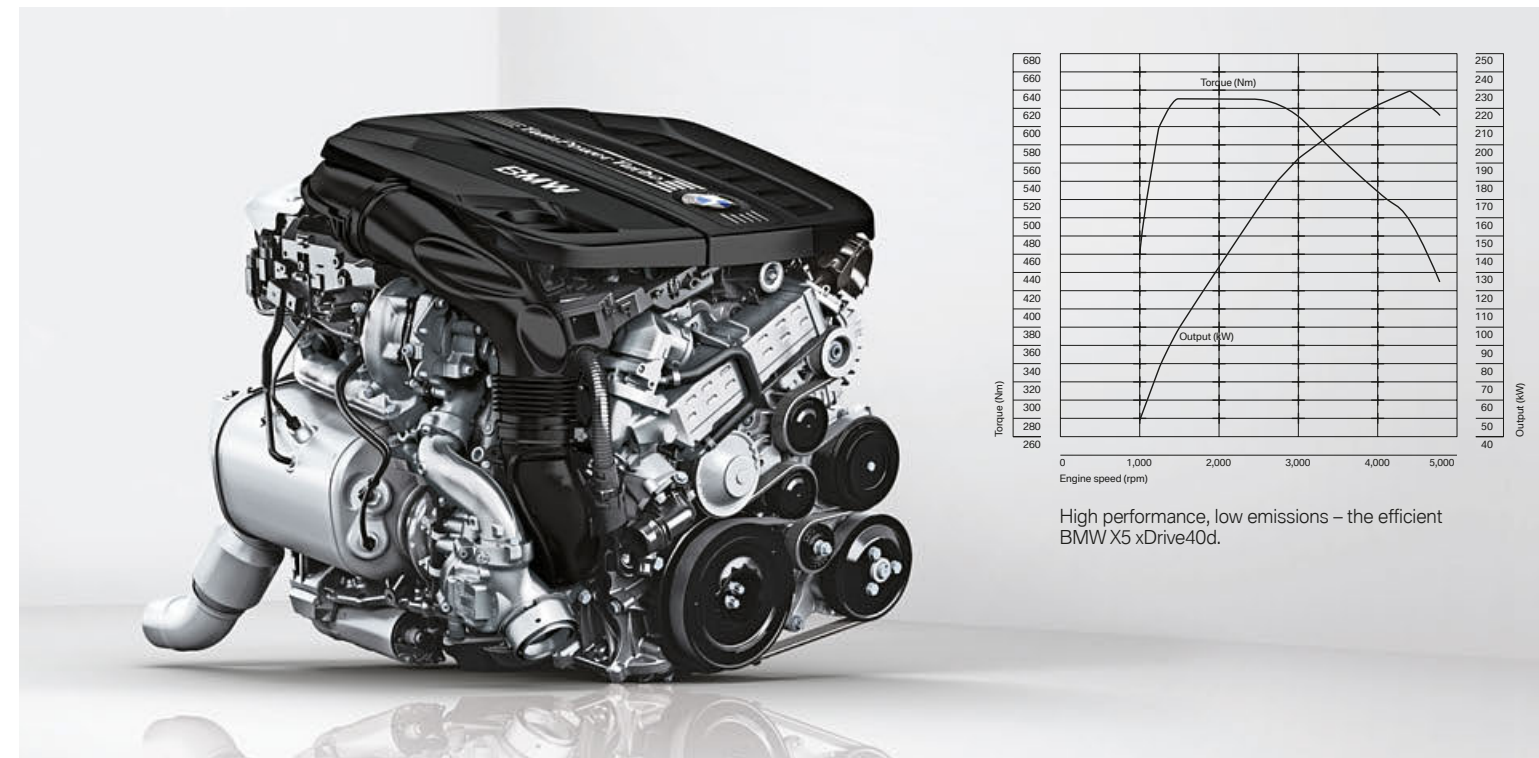

BMW X5 sDrive25d/xDrive25d.

The BMW TwinPower Turbo 4-cylinder diesel engine with a 2.0-litre capacity and an output of 170 kW (231 hp) combines CommonRail direct injection and a two-stage turbocharger with variable turbine geometry. The BMW X5 sDrive25d is the most efficient engine in the range. The BMW X5 sDrive25d comes with a rear-wheel drive as opposed to an all-wheel drive. The resulting weight distribution plays a major role in delivering particularly low fuel consumption and emission figures. Its maximum torque of 500 Nm is generated at an engine speed of just 2000 rpm. Both the BMW X5 sDrive25d and the xDrive25d accelerate from 0 to 100 km/h in 7.7 seconds and reach a top speed of 220 km/h. Average fuel consumption: 5.3–5.4 litres of diesel per 100 kilometres¹ (xDrive25d: 5.6 l¹). CO₂ emissions: 139–141 g/km¹ (xDrive25d: 146–148 g/km¹). The BMW xDrive all-wheel drive system further increases traction and directional stability.

BMW X5 xDrive30d.

The BMW TwinPower Turbo six-cylinder in-line diesel engine with a capacity of 3.0 litres combines CommonRail direct injection and a turbocharger with variable turbine geometry. At engine speeds as low as 1500 rpm, this 190 kW (258 hp) powerplant delivers an impressive 560 Nm of torque and takes just 6.8 seconds to sprint from 0 to 100 km. It consumes an average of just 5.9–6.0 litres per 100 km¹, with CO₂ emissions of just 156–158 g/km¹.

BMW X5 xDrive40d.

This diesel engine features impressive BMW TwinPower Turbo technology that combines CommonRail direct injection and a two-stage turbocharging system with variable turbine geometry to generate an output of 230 kW (313 hp) and a maximum torque of 630 Nm at just 1500 rpm. The BMW X5 xDrive40d delivers an outstanding performance while keeping fuel consumption and CO₂ emissions remarkably low (6.0 litres per 100 km¹ and 157–159 g/km¹, respectively). It takes just 5.9 seconds to power from 0 to 100 km/h and has a top speed of 236 km/h.

THE BMW X5 xDrive40e PLUG-IN HYBRID.

iPERFORMANCE

The BMW X5 xDrive40e iPerformance¹ combines the super-efficient eDrive iPerformance plug-in hybrid drive with the intelligent and variable BMW xDrive all-wheel drive system. It therefore allows short distances to be covered in an all-electric manner – producing no local emissions – while also delivering extreme dynamism and the ultimate in traction. The drive's key components consist of a 180 kW (245 hp) 4-cylinder petrol engine with BMW TwinPower Turbo technology, an 83 kW (113 hp) electric motor, a high-voltage lithium-ion battery with a capacity of 9.2 kilowatt hours, along with the intelligent BMW xDrive all-wheel drive, which guarantees supreme traction, optimised directional stability and increased agility, even when powered exclusively by electricity and regardless of the weather or road conditions. Intelligent energy management regulates the efficient interplay between the electric motor, the engine and the all-wheel drive system. Depending on the battery's charging status and the amount of power required, the electric motor can drive the vehicle by itself, or support the regular engine. During coasting and braking, it is even able to convert kinetic energy into electrical energy that is then fed into the high-voltage battery. Driven by electric power alone, the vehicle has a range of up to approx. 30 km, with an all-electric top speed of 120 km/h. Combined fuel consumption stands at 3.3–3.4 l/100 km², accompanied by CO₂ emissions of 77–78 g/km².

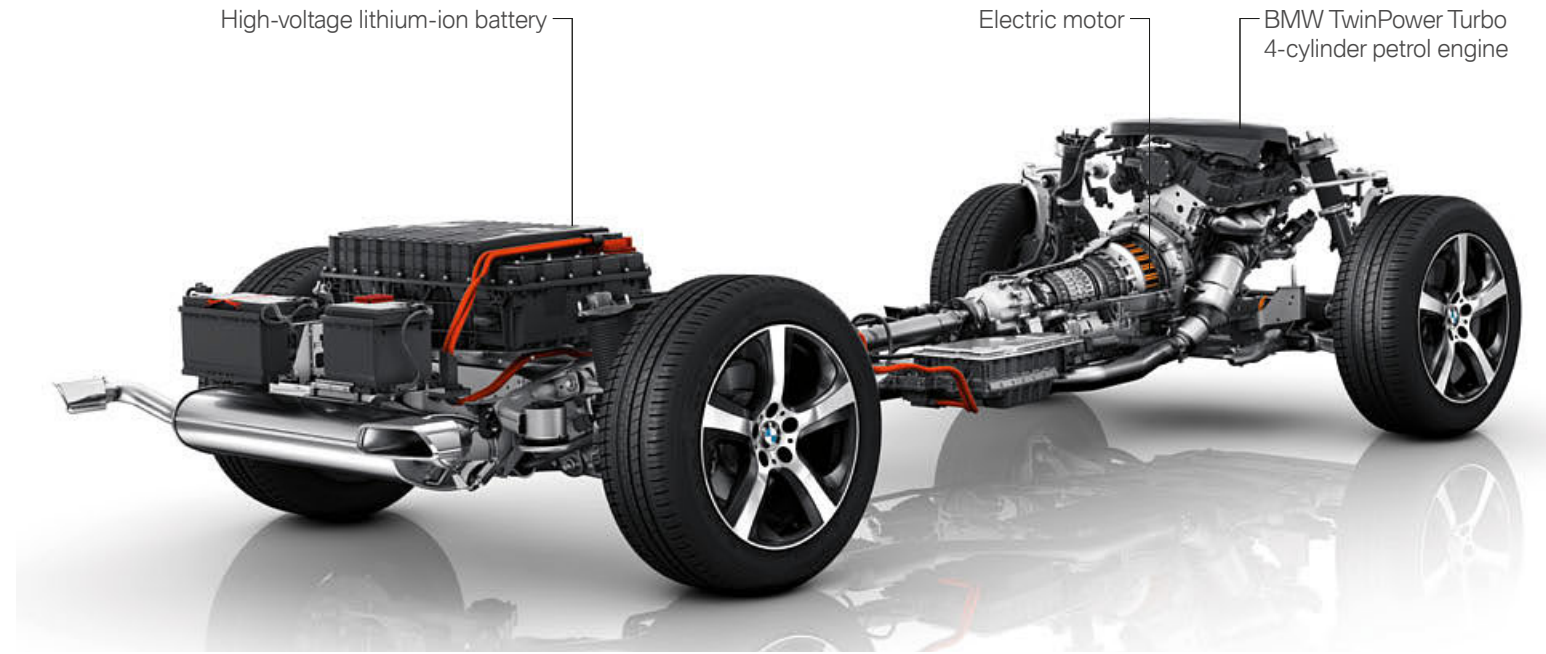

■ The **eDrive button** allows the driver to choose between three drive modes. The AUTO eDRIVE mode is active as standard. The MAX eDRIVE mode supports intentional all-electric driving. And the SAVE BATTERY mode is for charging the battery or maintaining its current charge level.

■ The **charging port** for the external charging of the high-voltage battery can be found behind a flap on the vehicle's front side panel on the left. The charging port is protected from harmful environmental effects by a special gasket ring. The LED light ring provides information regarding the various charging procedure statuses.

□ With the **Remote Services** of the BMW Connected App, various functions of the vehicle, such as locking and unlocking the car or displaying the car location, can be operated remotely. To use this feature, customers simply need to activate Remote Services once in the BMW ConnectedDrive customer portal at www.bmw-connecteddrive.com.



○ **BMW 360° Electric.** Thanks to the BMW i Wallboxes, the BMW X5 xDrive40e iPerformance can be easily and conveniently charged at your own parking spot at home. Charging is also possible at public charging stations or via any domestic power socket.

■ The **flat loading floor** has only been raised by a few centimetres in comparison with the BMW X5 with conventional drive. This means the luggage compartment remains virtually unchanged and can still be accessed directly. The flexibility associated with the divisible rear seat backrest is also maintained.

■ Externally, the iPerformance¹ model differs from conventionally powered models with the eDrive badge on the C-pillars on both sides, for example, as well as the i badge on the front side panels. The blue kidney grille slats and blue wheel hubs are also unmistakable signs of the vehicle's innovative drive technology.

¹ Planned availability of iPerformance equipment: December 2016.
² Fuel consumption and CO₂ emissions are affected by the selected wheel and tyre sizes. For more information please see pages 64/65 or consult your BMW partner.

Optional and standard equipment vary according to country.

THE BMW X5 M50d. M GENE INCLUDED.

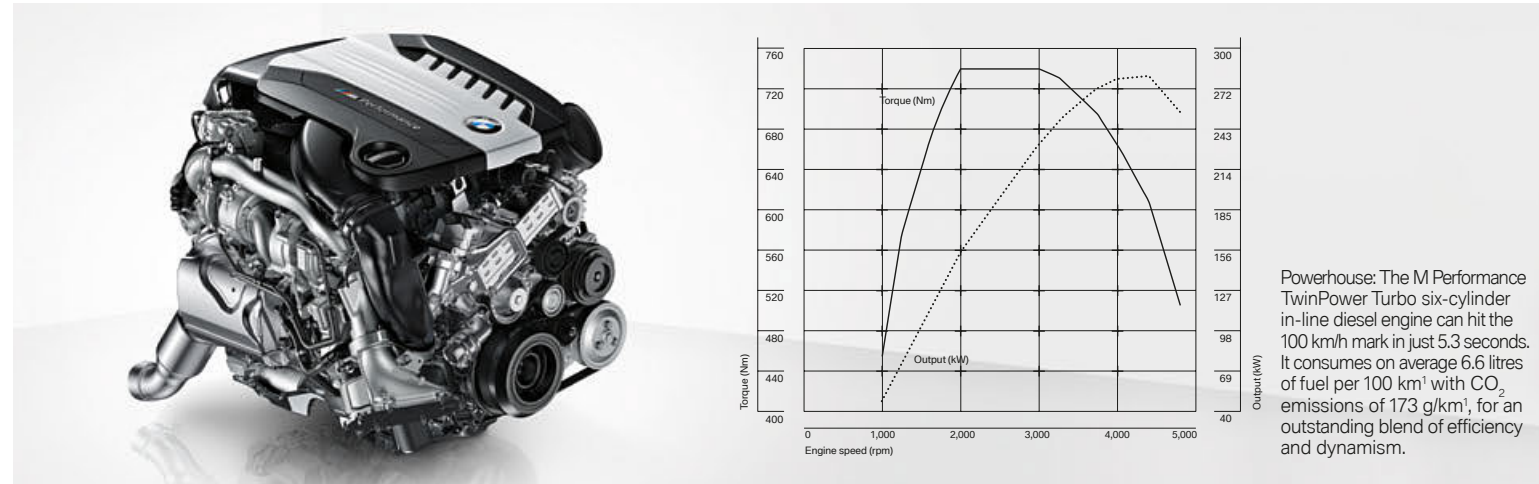

Eight-speed Steptronic sport transmission. Gear lever with the M logo.



Exhaust tailpipe. The trapezoidal tailpipes on the left and right are encased in a black chrome trim.



Logo. Striking M50d lettering in Dark Chrome.

The BMW X5 M50d has greatly benefited from the combined experience of the engineers of BMW M, whose expertise has ensured precision tuning between the drive, suspension and steering. Behind the wheel, you will enjoy precise, sporty handling for an exceptionally intense driving experience. The M Performance TwinPower Turbo engine has immensely satisfying acoustics and delivers a powerful output of 280 kW (381 hp)¹ and a maximum torque of 740 Nm. This force is transferred directly to the road with optimal traction thanks to the intelligent xDrive four-wheel drive. Its highly exclusive interior and exterior details are guaranteed to turn heads, such as the special air intakes in the front apron and exterior mirror caps in Ferric Grey metallic. These are perfectly complemented by optional 20" light alloy wheels in Double-spoke style 468 M with mixed tyres (shown here). The distinctive interior includes features such as door sill finishers with the 'M50d' logo, sport seats in Anthracite Alcantara/leather combination upholstery, the Aluminium Hexagon interior trim, along with the BMW Individual headliner in Anthracite.

¹Fuel consumption and CO₂ emissions are affected by the selected wheel and tyre sizes. For more information please see pages 64/65.





THE BEST FOUNDATION FOR SUPERIOR DRIVING DYNAMICS. AN OUTSTANDING SUSPENSION.

Optimised road holding is crucial for a truly dynamic driving experience. In the BMW X5, this is achieved by a weight distribution of almost 50:50 between the front and rear axles, as well as neutral steering behaviour, a high level of directional stability and fantastic traction courtesy of the intelligent xDrive four-wheel drive system. Read on to find out more.



xDrive¹. The intelligent BMW xDrive all-wheel drive system adapts perfectly to even the most challenging road surface conditions, ensuring optimal traction at all times. xDrive and Dynamic Stability Control (DSC) ensure that the BMW remains safe and stable. Controlled via the DSC sensor system, xDrive flexibly and quickly distributes drive power between the axles in order to prevent oversteer or understeer on bends, thereby ensuring outstanding directional stability. Moreover, it guarantees a rapid, safe acceleration even on slippery or steep stretches. In critical road conditions, the DSC doesn't need to intervene as much. BMW xDrive thus combines all the advantages of an all-wheel drive system – traction, directional stability and driving safety – with classic BMW agility.

Servotronic. The standard Servotronic feature adjusts the power steering to suit the current speed and also ensures a direct, precise steering response at high speeds. It also provides superior comfort by minimising the physical effort required when steering, while increasing agility when parking, manoeuvring, or navigating narrow or twisting roads.

Adaptive suspension packages. Suspension control systems for the BMW X5 are available in optional packages. This makes selecting your preferred driving dynamics option easier than ever before.

The **Comfort adaptive suspension package²** combines Dynamic Damper Control with air suspension on the rear axle for the ultimate in driving comfort. And whenever you want more athletic suspension settings, you can use the Driving Experience Control switch to activate one of the two more dynamic modes (standard with the X5 xDrive40e iPerformance³).

The **Dynamic adaptive suspension package⁴** allows you to further boost your car's dynamic potential. Encompassing both Dynamic Performance Control and Dynamic Drive, this package is guaranteed to deliver driving dynamics that are intrinsically sporty – as evidenced by the extremely neutral steering response and minimal body roll in bends. The **Professional adaptive suspension package^{2,4}** combines the components of both the Comfort and Dynamic adaptive suspension packages, thereby providing the ultimate in driving comfort while maximising the driving dynamics.

The **Adaptive M suspension⁵** extracts even more driving dynamics from your vehicle. The Dynamic Damper Control, included in the package, and air cushioning on the rear axle are tuned to deliver exceptionally sporty driving characteristics (standard with the X5 M50d).

¹ Not available with X5 sDrive25d.

² Not available with M50d.

³ Planned availability of iPerformance equipment: December 2016.

⁴ Not available with the X5 sDrive25d, X5 xDrive25d and X5 xDrive40e iPerformance.

⁵ Only available in conjunction with the M Sport package, not with X5 sDrive25d.

UNPARALLELED SAFETY WITH THE LATEST BMW TECHNOLOGIES.

The BMW X5 is equipped with cutting-edge technologies for every eventuality. Superb handling and innovative equipment come standard. Drivers benefit from the very latest technologies that provide optimal support at all times. You'll feel safe and protected, no matter where your journey takes you.

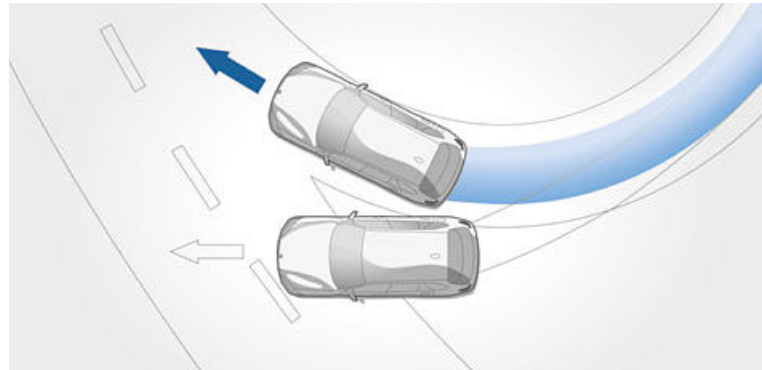

■ The **Dynamic Stability Control (DSC)** with extended functionality stabilises the vehicle as soon as any skidding motion is detected. Its extended functionality includes Cornering Brake Control (CBC), the hill-start and braking assistant, brake drying and braking readiness. For even more athletic driving, the Dynamic Traction Control (DTC) function allows increased wheel slip.

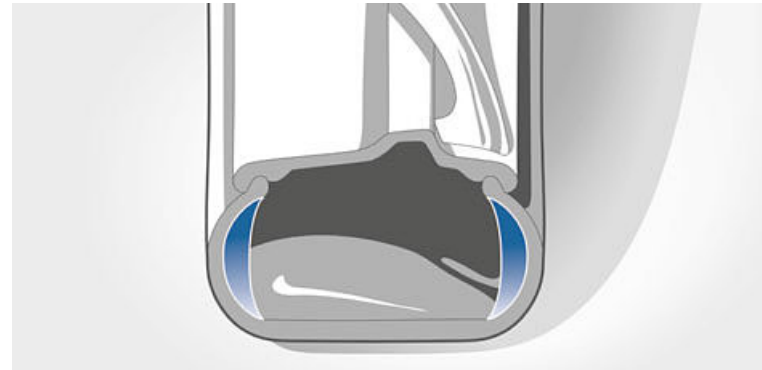

□ **Runflat tyres** feature reinforced side walls that prevent the tyres from completely collapsing or loosening from the rim if the air pressure drops. So in the event of a flat tyre, you'll be able to make it safely to the next repair shop.
 ■ Sensors record the tyre pressure for each wheel. A **Tyre pressure indicator** warns the driver in good time if there is any pressure loss.

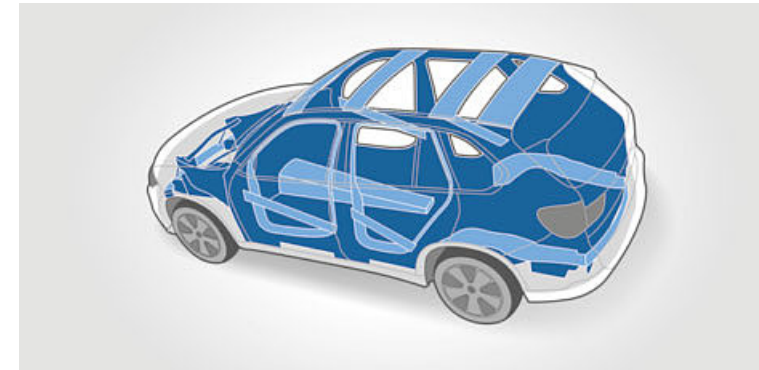

■ **Passenger cell.** BMW is dedicated to building extremely rigid passenger cells for every single model. This not only leads to increased steering precision and agility, but also provides greater safety for you and your passengers. The body only yields in precisely defined areas at the front and rear. Should an accident occur, these deformation zones are capable of absorbing a large amount of the impact, thereby minimising the severity of the collision as it happens.

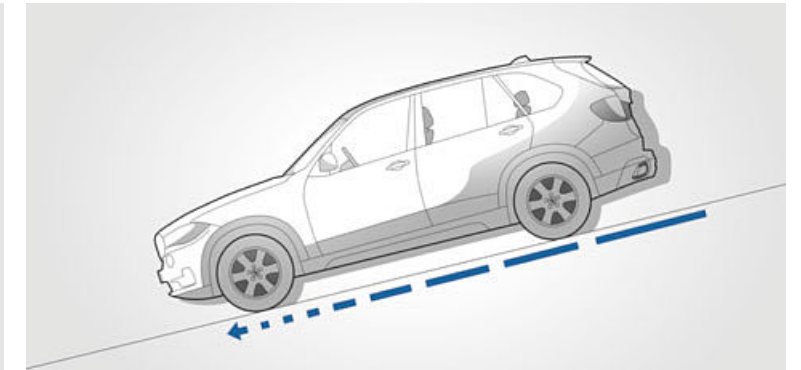

■ **Hill Descent Control (HDC)** in the xDrive models is a system which, when activated, ensures that the vehicle can negotiate the steepest downhill runs automatically and safely at just above walking pace, without the driver having to brake. (Not available with the X5 sDrive25d.)

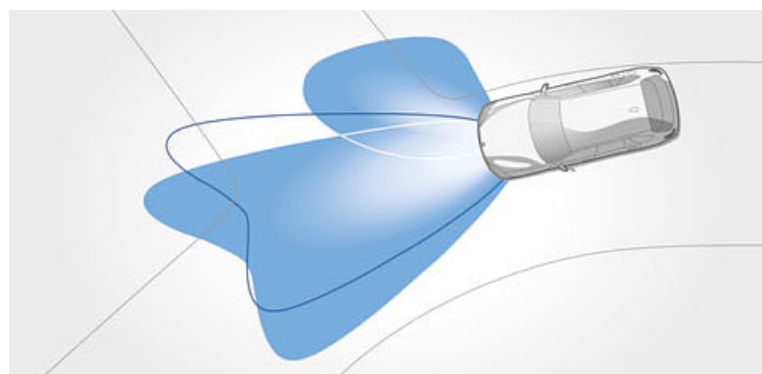

□ **Adaptive Headlights**, including variable city and motorway light distribution, BMW Selective Beam (anti-dazzle High-Beam Assistant) with automatic operation of the high-beam lights, as well as Bi-Xenon headlight technology, ensure excellent illumination of the road ahead. The cornering lights are automatically activated when the indicator is switched on or when the steering wheel is turned, even when the car is at a standstill.

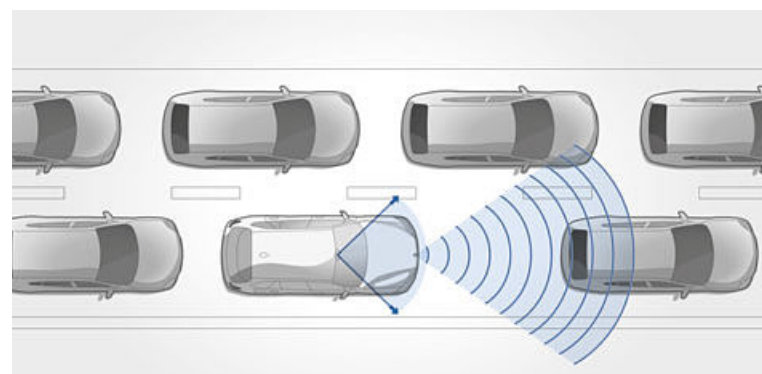

■ The **Driving Assistant** combines the Lane Departure Warning and Approach Warning systems. The Approach control and Person warning with light city braking function issues a warning if there is a risk of collision with vehicles or pedestrians and brakes the vehicle in the event of an emergency. From a speed of approx. 70 km/h, the Lane Departure Warning draws the driver's attention to an unintentional lane change by means of slight vibrations in the steering wheel.

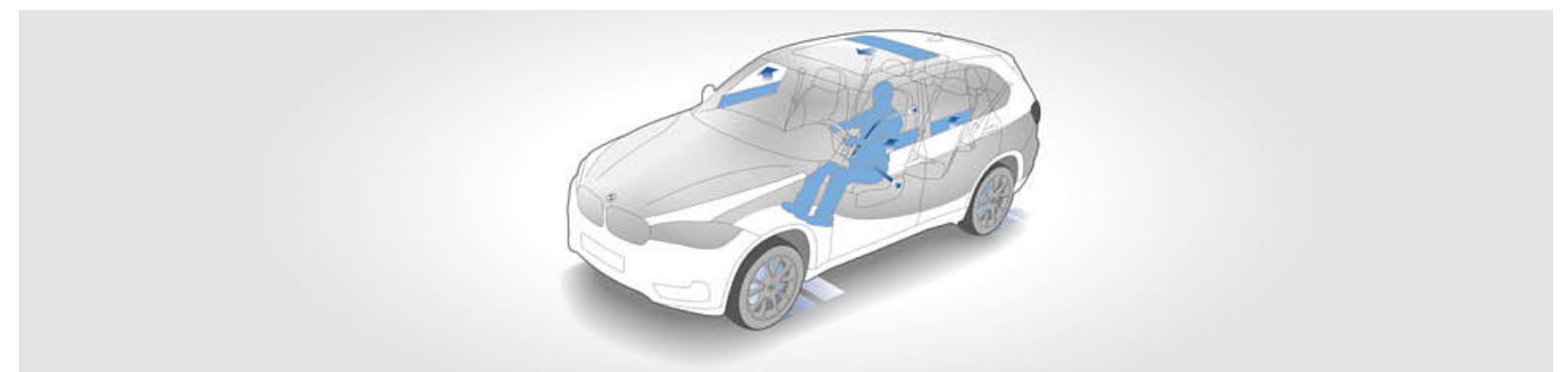

□ **Active Protection** is the BMW ConnectedDrive preventive passenger protection system. The system is activated after the engine is started and the front seat belts are automatically slightly tensioned when the car starts moving. In a critical driving situation such as an emergency brake, or if the vehicle demonstrates excessive understeer or oversteer, the front seat belts are pretensioned, the side windows and sliding roof are closed and the passenger seat backrest is returned to the upright position. If the vehicle is fitted with Approach control warning or Approach control warning with light braking function, imminent collisions with vehicles driving or stopped ahead can be recognised. If a crash could not be avoided and does ultimately occur, the system then brakes the car, without requiring intervention by the driver, until the vehicle reaches a standstill. This helps reduce the likelihood of a second or subsequent collision, and or reduce the effects thereof – or in the best case scenario could prevent a further collision altogether. The Attentiveness assistant also recognises if the driver is displaying signs of increasing inattentiveness or tiredness. This system analyses the steering response and reacts to irregular driving behaviour by issuing a message in the Control Display suggesting the driver to take a break and emitting an acoustic signal.

Optional and standard equipment vary according to country.

BASIC.



With its multi-level instrument panel, the cockpit exudes a sense of luxurious spaciousness. All the controls, along with the optional Navigation system Professional with Touch Display, are ergonomically arranged to best serve the needs of the driver. The standard leather steering wheel with multifunction buttons is a pleasure to hold. The capacious interior design features high-quality materials for a unique ambience and includes two cupholders in the front centre console and numerous storage options.



The interior design shown here features standard seats in optional leather 'Dakota' Canberra Beige (standard with the X5 xDrive50i) and the optional fine-wood trim Poplar Grain (standard with the X5 xDrive40d and X5 xDrive50i).



The BMW X5 is available with a wide range of attractive optional 19" and 20" light alloy wheels. The image above shows a 19" BMW light-alloy wheel in V-spoke style 450 (standard with the X5 xDrive50i).



The BMW X5 sDrive25d with the optional Space Grey metallic paint finish.

PURE EXPERIENCE DESIGN.

Equipment features of the Exterior package:

- BMW kidney grille with exclusively designed slats in Silver matt
- front bumper with specific design elements in Silver matt and underbody protection design element in brushed stainless steel
- side window frames and window recess finishers in Pearl Chrome, B-pillar and C-pillar, mirror base and mirror foot in Black high-gloss
- rear bumper with characteristic design elements in Silver matt
- rear underbody protection in brushed stainless steel, stainless steel look at sides
- tailpipe trim in Silver matt
- car key with Pearl Chrome buttons and detailing

Special recommendation for the Design Pure Experience:

- 19" light alloy wheels Star-spoke style 449
- roof railing Aluminium satinised

BMW Individual:

The BMW Individual features perfectly complement the Pure Experience design (see pages 46/47).

Equipment features of the Interior package:

- seats in Exclusive leather 'Nappa' Mocha upholstery, extended, with contrast stitching in Nut Brown
- interior trim finishers in fine-wood trim 'Fineline Pure' textured dark, American Oak Anthracite high-gloss, Poplar Grain or interior trim finishers in Aluminium high finish
- instrument panel upholstered in leather 'Walknappa' Black with contrast stitching in Nut Brown
- door shoulders in leather 'Walknappa' Black with contrast stitching in Nut Brown
- car key with Pearl-Gloss Chrome buttons and detailing
- seat heating for driver and front passenger

Pure Experience design combinations:

The Pure Experience interior design can also be combined with the Pure Excellence exterior design and the M Sport package.



■ Car key with Pearl-Gloss Chrome detailing.



□ 19" light alloy wheels Star-spoke style 449, 9 J x 19 with 255/50 R 19 tyres.



■ The instrument panel with Black Walknappa leather upholstery features contrast stitching in Nut Brown for an even more sophisticated look.

□ The comfort seats for driver and passenger with electric seat adjustment in Exclusive leather 'Nappa' Mocha perfectly match the interior trim finisher in Fineline Pure fine-wood trim. The interior design is further enhanced by the extended leather trim on the door shoulders and instrument panel.



Optional and standard equipment vary according to country.

The BMW X5 xDrive50i with the exterior design Pure Experience and the optional Imperial Blue brilliant effect metallic paint finish. The image also shows the optional aluminium running board.

PURE EXCELLENCE DESIGN.

The Pure Excellence exterior design features:

- BMW kidney grille with exclusively designed vertical slats with front sides and lower front ornamental grille in Black matt
- Front bumper with specific design elements in Chrome
- Side window surrounds and window recess finisher in Chrome, B-pillar and C-pillar, mirror base and mirror foot in Black high-gloss
- Wheel arch trim in body colour
- Rear bumper with specific design elements in Chrome
- Sump guard design element rear and side in body colour
- Car key with buttons and detailing in Pearl Chrome

Special recommendation for the Pure Excellence design:

- 19" light alloy wheels Multi-spoke style 448
- BMW Individual High-Gloss Shadow Line roof railing

BMW Individual:

The BMW Individual features perfectly complement the Pure Excellence design (see pages 46/47).

The Pure Excellence interior design features:

- Seats in Exclusive leather 'Nappa' Ivory White with extended features and contrast stitching in Atlas Grey
- Car key with buttons and detailing in Pearl Chrome
- Interior trim finishers in fine-wood trim American Oak Anthracite high-gloss, poplar grain, 'Fineline Pure' textured dark or Interior trim finishers in Aluminium high finish
- Instrument panel in leather 'Walknappa' black with contrast stitching Parchment
- Door panels in Leather 'Walknappa' black with contrast stitching Parchment
- Seat heating for driver and front passenger

Pure Excellence design combinations:

The Pure Excellence interior design can also be combined with the Pure Experience exterior design and the M Sport package.



■ Car key with Pearl-Gloss Chrome detailing.



□ 19" light alloy wheels Multi-spoke style 448, 9 J x 19 with 255/50 R 19 tyres.



■ The instrument panel in Black 'Walknappa' leather accentuates the exclusive interior design with its Pergament contrast stitching.

□ The comfort seats for the driver and passenger with electric seat adjustment (shown here with the optional active seat ventilation at the front) are shown here in Exclusive leather 'Nappa' Ivory White with extended contents. The high-gloss American Oak Anthracite fine-wood trim adds a harmonious finishing touch to the high-grade interior.



M SPORT PACKAGE.

M Sport package exterior equipment:

- M Aerodynamics package with front apron, side skirts, wheel arch trims, in body colour
- 19" M light alloy wheels Double-spoke style 467 M with mixed tyres
- 20" M light alloy wheels Double-spoke style 469 M with mixed, other wheels available
- Adaptive M suspension (not available with X5 sDrive25d)
- Adaptive suspension package 'Dynamic' (not available with X5 sDrive25d, X5 xDrive25d and X5 xDrive40e)
- BMW Individual High-Gloss Shadow Line
- BMW Individual Exterior Line Aluminium satinated
- M designation on the sides
- Exterior mirror caps in body colour
- Tailpipe trim strip in Chrome high-gloss in M Sport package specific design
- Exclusive paintwork in Carbon Black metallic; other paintworks available
- BMW Individual roof rails High-Gloss Shadow Line
- Roof rails Aluminium satinated

BMW Individual:

The BMW Individual features perfectly complement the M Sport package (see pages 46/47).

M Sport package interior equipment:

- M door sill finishers, M driver footrest
- Sport seats for driver and front passenger
- Exclusive Alcantara/leather combination with M designation on the seat piping, other upholsteries available
- M Leather steering wheel with multifunction buttons and gearshift paddles
- BMW Individual headliner Anthracite
- Interior trim finishers in Aluminium Hexagon; other trims available
- Car key with exclusive M designation

M Sport package combinations:

The M Sport package can also be combined with the Pure Experience interior design or the Pure Excellence interior design.



■ The standard sport seats featuring exclusive optional Alcantara/leather combination upholstery with M labelling in the piping and the M leather steering wheel lend the interior a particularly sporty feel.



■ Sporty look: door sill finishers in aluminium with the 'M' logo.



■ Car key with 'M' design.



■ 20" M light alloy wheels Double-spoke style 469 M Jet Black with mixed tyres, front size 10J x 20 with 275/40 R20 tyres, rear 11J x 20 with 315/35 R20 tyres.



□ 20" M light alloy wheels Double-spoke style 469 M with mixed tyres, front 10J x 20 with 275/40 R20 tyres, rear 11J x 20 with 315/35 R20 tyres.



powered by 

Optional and standard equipment vary according to country.

BMW Individual

The expression of personality.



BMW Individual paint finish
Ruby Black metallic.



The BMW X5. Inspired by BMW Individual.

□ Driving a BMW is, in itself, a mark of character. There are those who still, however, want their vehicles to be even more individual reflections of their personality. The BMW Individual Collection and the BMW Individual Manufaktur meet these needs by opening up seemingly limitless opportunities for differentiation.

Precisely in tune with each model, the BMW Individual Collection offers a highly exclusive selection of equipment options. Fascinating paint finishes either refracting the light or with a matt effect. Leather, unique in colour and scope of application, perfected with clever contrasts and decorative stitching. Interior trims in the most exclusive fine woods, the immaculate Piano finish and the finest leather.

And yet even this can be surpassed – thanks to the BMW Individual Manufaktur. Here, there is only one goal: realising almost any customer request, even the most personal, with stylish, hand-crafted perfection.



BMW Individual paint finish Ruby Black metallic and
20" BMW Individual light alloy wheels V-spoke style 551 I.



BMW Individual extended fine-grain Merino leather upholstery in Amaro Brown
with contrast stitching and elegant contrast piping in black.



EXTERIOR COLOURS.

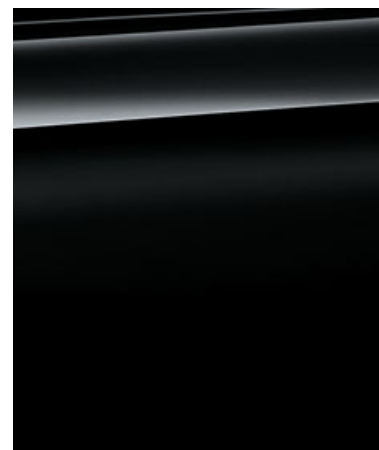

■ **Non-metallic** 668 Black¹



□ **Metallic** A90 Sophisto Grey Brilliant Effect¹



□ **Metallic** A83 Glacier Silver

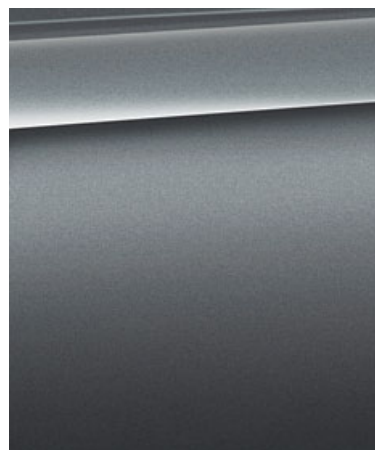

□ **Metallic** A52 Space Grey



□ **Non-metallic** 300 Alpine White²

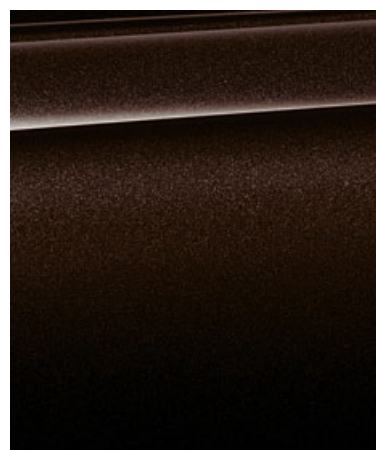

□ **Metallic** B53 Sparkling Brown Brilliant Effect¹

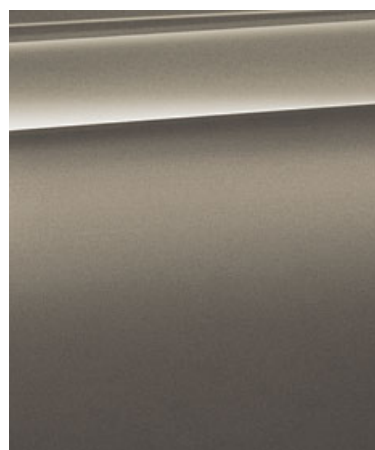

□ **Metallic** C2P Atlas Cedar¹



□ **Metallic** A96 Mineral White

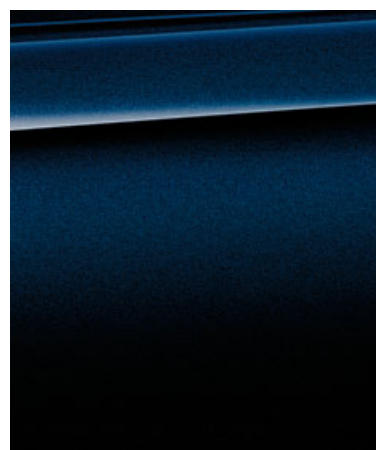

□ **Metallic** A89 Imperial Blue Brilliant Effect¹

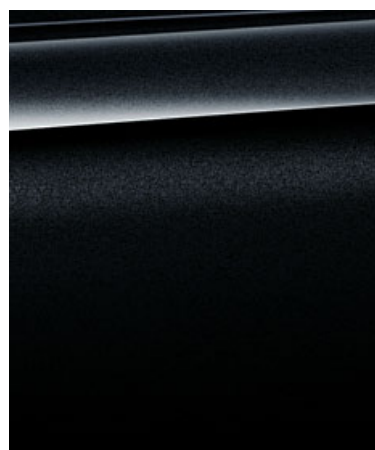

□ **Metallic** 475 Black Sapphire

M SPORT PACKAGE

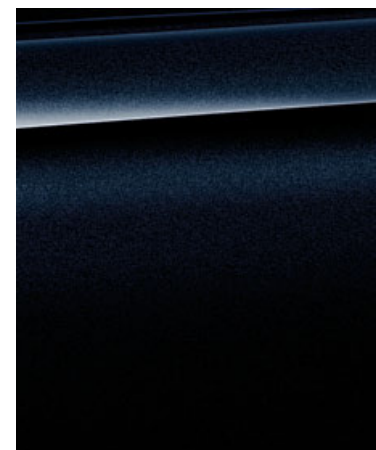

□ **Metallic** 416 Carbon Black³

BMW INDIVIDUAL



□ **BMW Individual** X01 Pearl Silver metallic

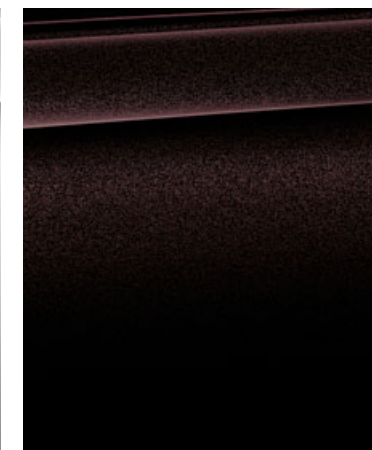

□ **BMW Individual** X03 Ruby Black metallic

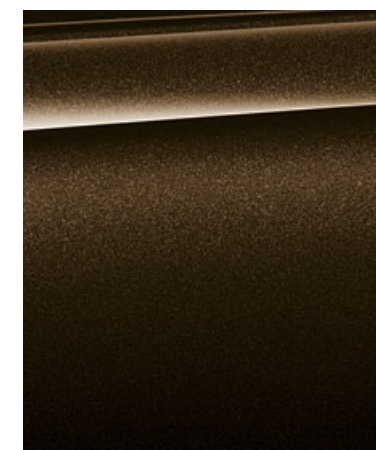

□ **BMW Individual** X13 Pyrite Brown metallic

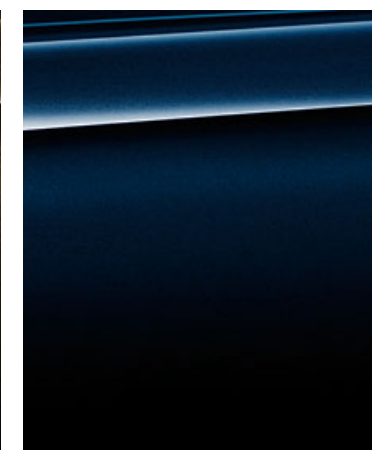

□ **BMW Individual** S34 Azurite Black metallic

¹ Not available with the M Sport package and M50d.

² Standard with the M Sport package and M50d.

³ Only in conjunction with the M Sport package and M50d.

Optional and standard equipment vary according to country.

[Colour samples] These colour samples are intended as an initial guide to the colours and materials available for your BMW. However, experience has shown that printed versions of paint, upholstery and interior trim colours cannot in all cases faithfully reproduce the appearance of the original colour. Please discuss your preferred colour choices with your BMW partner or dealership. They will be happy to show you original samples and assist you with special requests.

INTERIOR COLOURS.

UPHOLSTERY COLOURS



■ **Twill cloth AVAT Anthracite**^{1,7,10,11}
interior colour black

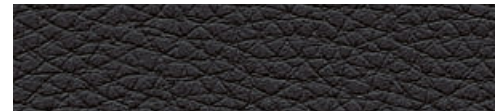

□ **Dakota leather LCSW Black**^{4,17}
interior colour black



□ **Dakota leather LCEW Ivory White**
interior colour black



□ **Exclusive leather 'Nappa'** with extended trims
NAEW Ivory White^{4,5}, interior colour Black



□ **Alcantara/leather combination**
GMAT Anthracite^{3,11,12,16}, interior colour black

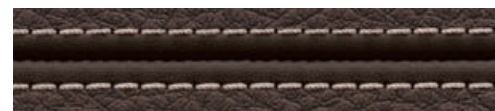

□ **Dakota leather LCMY Mocha**^{7,12}
interior colour black



□ **Exclusive Nappa leather, extended**
NAMY Mocha^{4,6} interior colour black



□ **Dakota leather LCB8 Terra**¹⁷
interior colour black

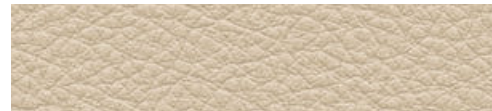

□ **Dakota leather LCCY Canberra Beige**^{4,17}
interior colour Canberra Beige

INTERIOR COLOURS



Black with headliner in Everest Grey



Canberra Beige with headliner in Oyster

INTERIOR TRIMS



■ 4DY Oxide Silver dark, matt^{1,15}



□ 4B9 Fine Brushed Aluminium



□ 4AC Poplar Grain fine-wood trim (standard with
X5 xDrive50i and X5 xDrive40d)

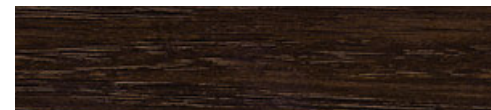

□ 4CV American Oak fine-wood trim in Anthracite,
high-gloss



□ 4DD Finline Pure fine-wood trim, textured, dark



■ 4MR Aluminium Hexagon^{2,3}

BMW INDIVIDUAL UPHOLSTERY COLOURS



□ **BMW Individual fine-grain Merino leather**
ZAFU Smoke White^{8,9,11}



□ **BMW Individual fine-grain Merino leather**
ZAN3 Taupe^{8,9,11}



□ **BMW Individual fine-grain Merino leather**
ZAP5 Amaro Brown^{8,9,11}



□ **BMW Individual fine-grain Merino leather**
ZAML Nutmeg^{8,9,11}



□ **BMW Individual fine-grain Merino leather**
ZAP3 Criollo Brown^{8,9,11}

BMW INDIVIDUAL INTERIOR COLOURS



□ **BMW Individual headliner**
XD5 Alcantara Smoke White¹³



□ **BMW Individual headliner**
XD5 Alcantara Scotch dark¹⁴



□ **BMW Individual headliner**
776 Alcantara Anthracite



□ **BMW Individual headliner**
775 Anthracite²

BMW INDIVIDUAL INTERIOR TRIMS



□ **BMW Individual interior trim**
XEW Fine-wood trim Sen Light Brown



□ **BMW Individual interior trim**
4WC Fine-wood trim Ash Vulcano Brown



□ **BMW Individual interior trim**
XE7 Piano finish Black

¹ Not available with the M Sport package and M50d.

² Standard with the M Sports package and M50d.

³ Only in conjunction with the M Sport package and M50d.

⁴ In conjunction with the optional active seat ventilation at the front, the leather 'Dakota' upholstery comes with perforated surfaces on the front seats, while the exclusive leather 'Nappa' upholstery comes with perforated surfaces on the front and rear seats.

⁵ Only available with interior design Pure Excellence.

⁶ Only available with interior design Pure Experience.

⁷ Not available in conjunction with the BMW Individual instrument panel with leather finish (4M5).

⁸ BMW Individual extended leather trim in fine-grain Merino includes the front and rear seats, headrests, rear panels on the front seat backrests, door panel inserts, centre console including armrest, armrests in the doors and the door handles.

⁹ Seats with contrast piping, contrast stitching and decorative perforation (decorative perforation not available in conjunction with the optional active seat ventilation at the front). If the optional third row of seats (4UB) is chosen, all seats are only available in leather 'Dakota' Black.

¹⁰ Only available in conjunction with the standard seats.

¹¹ Not available in conjunction with the third row of seats.

¹² Not available in conjunction with the comfort seats in front.

¹³ Only available in conjunction with BMW Individual fine-grain Merino leather in Amaro Brown, Criollo Brown or Smoke White.

¹⁴ Only available in conjunction with BMW Individual fine-grain Merino leather in Taupe or Nutmeg.

¹⁵ Not available in conjunction with the interior design Pure Excellence or interior design Pure Experience.

¹⁶ Standard with the M50d.

¹⁷ Planned availability with contrast stitching from December 2016.

Dakota leather standard with X5 xDrive50i.

Optional and standard equipment vary according to country.

Please note that even normal long or short-term use can lead to unrecoverable upholstery damage. This can be caused in particular by non-colourfast clothing.

Standard / Optional equipment.



■ **Rear lights with LED light elements** each feature two individual high-performance LED light elements, which have a distinctive design and make the BMW easily recognisable from behind even at night.



■ The **Headlight washer system** automatically cleans the headlights when the front windscreen washing function is activated and the headlights are on.

□ The **Adaptive LED headlights** adjust their light distribution according to speed and steering angle. They provide optimum illumination of the road ahead, improve visibility in the dark and feature a range of functions: highlighters, light rings, anti-dazzle function, BMW Selective Beam, fog lights, cornering lights, indicators, daytime running lights and Adaptive headlights.

■ **Xenon Headlights** with high and low beam functions, includes headlight washing system, LED accent lights, automatic headlight range control, as well as four LED light rings that serve as parking lights and daytime running lights.

□ The **Adaptive Headlights** including variable city and motorway light distribution, BMW Selective Beam (anti-dazzle High-Beam Assistant) with automatic operation of the high-beam lights, as well as Bi-Xenon headlight technology, ensure excellent illumination of the road ahead.



■ The light generated by the **LED fog lights** is very similar to daylight and enables the driver to see better and drive more safely in inclement weather.



■ The **Rain sensor including automatic headlight activation** automatically activates the windscreen wipers and the low-beam headlights.
□ **BMW Selective Beam** (anti-dazzle High-Beam Assistant) optimally illuminates the road at night with high-beam light – without dazzling others on the road. This feature is only available in conjunction with the Adaptive LED Headlights or Adaptive Headlights.



■ **Air Breather** located in the front wheel arches channels the air flow at the front wheels. This decreases air resistance, thereby reducing the vehicle's fuel consumption and CO₂ emissions output.



□ **Roof railing in matt Black** sits flat on the roof, perfectly matches the exterior design and serves as the base for a multifunctional BMW roof rack system (not available with M50d).



□ **Roof railing in satin-finish Aluminium** sits flat on the roof, perfectly matches the exterior design and serves as the base for a multifunctional BMW roof rack system. Particularly well-suited to the Pure Experience design package.



□ **BMW Individual High-Gloss Shadow Line roof railing** in high-gloss Black for a truly striking aesthetic. Anodised and flush with the roof, it serves as the base for a multifunctional BMW roof rack system. Particularly well-suited to the Pure Excellence design package.



□ The **BMW Individual High-Gloss Shadow Line** includes numerous features in high-gloss black: side window trim, window recess finishers, window guides, trim on the B and C-pillars and mirror bases (standard with the M50d).



□ **BMW Individual Exterior Line** in satin-finish Aluminium.
□ The **Sun protection glazing** for the rear window and tinted rear side windows reduces unwanted warming of the interior.



■ **Tailgate**, two-part, for easy access to the luggage compartment. The upper part can be opened and closed using the automatic tailgate operation control; it swings upwards, creating a wide opening. When the lower part is open, it forms a platform that can be locked in line with the floor of the luggage compartment.



□ **Aluminium running board** with a brushed, anodised surface and rubber inserts. This stylish design element provides added convenience when getting in and out of the car. Not available with M50d and the M Sport package.
□ **Soft Close Automatic** gently pulls the doors closed.



□ **Tow bar** can be electronically adjusted and folded away entirely under the rear apron. It also includes trailer stability control. The maximum trailer load is 3,500 kg, depending on the engine fitted.

Optional and standard equipment vary according to country.

Standard / Optional equipment.



□ **20" light alloy wheels Y-spoke style 451** with mixed tyres, front 10 J x 20 with 275/40 R 20 tyres, rear 11 J x 20 with 315/35 R 20 tyres.



■ **18" light alloy wheels Double-spoke style 446**, 8.5 J x 18 with 255/55 R 18 tyres.



□ **19" light alloy wheels Star-spoke style 490, BMW EfficientDynamics**, 9 J x 19 with 255/50 R 19 tyres.



□ **19" light alloy wheels W-spoke style 447** in Orbit Grey, gloss-lathed with mixed tyres, front 9J x 19 with 255/50 R 19 tyres, rear 10J x 19 with 285/45 R 19 tyres.



□ **19" light alloy wheels Multi-spoke style 448**, 9 J x 19 with 255/50 R 19 tyres. Particularly well-suited to the Pure Excellence design package.



□ **19" light alloy wheels Star-spoke style 449**, 9 J x 19 with 255/50 R 19 tyres. Particularly well-suited to the Pure Experience design package.



□ **19" light alloy wheels V-spoke style 450**, 9 J x 19 with 255/50 R 19 tyres. (Standard with X5 xDrive50i.)



□ **20" light alloy wheels Star-spoke style 491** with mixed tyres, Black high-gloss, front 10 J x 20 with 275/40 R 20 tyres, rear 11 J x 20 with 315/35 R 20 tyres.



□ **20" BMW Individual light alloy wheels V-spoke style 551 I** with mixed tyres, front 10 J x 20 with 275/40 R 20 tyres, rear 11 J x 20 with 315/35 R 20 tyres.

All 19" and 20" light alloy wheels feature runflat tyres. Optional and standard equipment vary according to country.



□ **M Leather steering wheel** including multifunction buttons, steering wheel rim in leather 'Walknappa' Black with contoured thumb rests.¹
□ The **Steering-wheel heating** quickly warms up the rim of the steering wheel at the push of a button – which is especially comfortable in winter.



□ **Sport leather steering wheel**, black, three-spoke, with multifunction buttons and chrome inlay.
■ **Servotronic** adapts the steering power to suit the speed.



■ **Leather steering wheel with multifunction buttons** for operating the Cruise Control and the radio or telephone.



□ **BMW Individual leather steering wheel** in the sport leather steering wheel design with wooden inlays to match the respective BMW Individual interior trim.

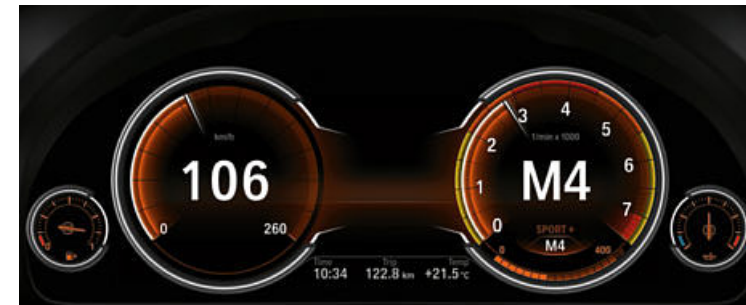

□ The **Multifunctional Instrument Display²** with Black Panel technology and a screen diagonal of 10.25" provides an impressive visualisation of the driving experience. Three different modes and their specific characteristics – each of which have their own colour scheme and graphic style – can be shown in the display: COMFORT, ECO PRO and SPORT modes.



□ The **full-colour BMW Head-Up Display³** projects relevant driving information directly into the driver's line of sight, allowing the driver to concentrate more closely on the road ahead. The display includes information such as the current speed, navigation directions, Speed Limit Info incl. no-overtaking indicator, along with telephone and entertainment lists.



■ **Parking brake with auto-hold function** can be conveniently activated via a button in the centre console. The brake is released once the accelerator is depressed. The auto-hold function assists the driver in stop-start traffic, or during hill starts, by preventing the car from rolling forwards or backwards when at a standstill.



■ The **8-speed Steptronic transmission** ensures particularly smooth gearshifts and outstanding driving comfort, thanks to fast engine speed transitions and tightly spaced gear ratios. It unites superb comfort with impressive dynamics and increased fuel efficiency.

¹ Standard with X5 M50d.

² Not available with the X5 xDrive40 iPerformance.

³ The information in the Head-Up Display is not fully visible when wearing polarised sunglasses. The exact content shown will depend on the equipment options chosen. Further optional equipment is required for additional displays.

Standard / Optional equipment.



□ **BMW Night Vision with Dynamic Light Spots** can detect people and larger animals at night – even at a significant distance – and illuminates them. An infrared camera mounted on the BMW kidney grille transmits images of people and animals directly onto the Control Display.



□ **Navigation System Professional** incl. hands-free kit, with USB interface, fixed 10.2" LCD colour display with split screen function (main and assistance windows), Radio Professional with DVD drive, 20 GB storage capacity for audio files. The unit is operated intuitively via the iDrive Controller with direct menu control buttons and eight functional bookmarks. Maps are displayed in 3D with satellite background images. Selected sights are shown as photorealistic images.



□ **Surround View** makes it easier to park and manoeuvre in tight spaces. The area behind and either side of the car is shown on the Control Display from a bird's eye perspective (Top View). This is combined with Side View, which assists the driver when approaching areas with limited visibility (e.g. when exiting driveways or side streets).



□ **Park Assistant** makes it easier to parallel park in roadside spaces. Suitable parking spaces can be shown and selected via the Control Display. When the driver holds down the button, the system actively takes over the task of parking the car by selecting the right gear, steering, accelerating and braking as required.



□ **Driving Assistant Plus*** includes Approach Warning and Lane Departure Warning, as well as Active Cruise Control with Stop&Go function (shown here) and the Traffic-queue assistant*. These features increase safety and convenience when driving on motorways.



■ **Driving Experience Control** offers the driver the choice between the standard COMFORT mode, the more efficient ECO PRO mode, and the SPORT and SPORT+ modes, for an even more dynamic drive. ECO PRO mode adjusts the characteristics of the Steptronic transmission (if present) and the heating/air conditioning settings to make the drive as fuel-efficient as possible.



□ **Traffic-queue assistant** controls the speed of the car and distance from the car ahead in dense traffic on motorways at speeds of up to 60 km/h, and even takes over steering.



□ **Lane Change Warning** alerts the driver to vehicles in the blind spot as well as vehicles in the neighbouring lane by means of a visual signal and vibration in the steering wheel.



□ The **Rear view camera** shows the area behind the vehicle on the Control Display. Interactive track lines and obstacle markings also help the driver when reversing.



■ **Front and rear Park Distance Control (PDC)** makes parking and manoeuvring in tight spaces much easier.



□ **iDrive Touch Controller (part of the Navigation System Professional).** You can easily enter destination addresses (for example) into the navigation system using your own handwriting via the touchpad integrated into the Controller.



□ **Ceramic surrounds for the controls** includes for example the gear lever, the front Controller, as well as the temperature and volume dials. For a uniquely refined interior aesthetic.



□ Telephony with wireless charging offers a comprehensive telephony package with Bluetooth connectivity, an NFC interface and the technical capacity for a WiFi hotspot.
 ■ The **hands-free facility with USB interface** enables the user to wirelessly connect Bluetooth-capable mobile phones¹ to the car and access compatible external audio sources.



□ **Real Time Traffic Information*** almost instantly delivers traffic information about motorways, country roads and main roads, as well as numerous urban routes.



□ **Internet*** provides access to the World Wide Web on the Control Display and includes a data flat rate (no roaming). The iDrive Controller is used to surf the internet.



□ When the vehicle is parked, the **TV function*** means that the car can receive digital television, including teletext and electronic programme guides.



■ **xDrive Status²** provides information relevant for offroad driving on the instrument panel and the Control Display. In addition to the compass function (only in conjunction with Navigation System Professional), it also shows the car's angle of inclination both visually and in degrees.

* May not be available in all countries. Please consult your BMW partner.
¹ For information on compatible devices see www.bmw.com/bluetooth.
² Not available with X5 sDrive25d.

Optional and standard equipment vary according to country.

Standard / Optional equipment.



□ **BMW Individual instrument panel (4M5)** with black Walknappa leather upholstery on the top surface. This sophisticated feature also includes door shoulders upholstered in black Walknappa leather, for a particularly luxurious interior aesthetic.



□ **BMW Individual leather-upholstered instrument panel (XT1):** The upper part and the door panels are in Walknappa leather (black or Scotch dark)¹. The lower part of the instrument panel is upholstered in fine-grain Merino leather in the BMW Individual upholstery colour. The upper and lower parts of the instrument panel and the door panels feature contrast stitching. Only available in conjunction with BMW Individual fine-grain Merino leather.



□ **BMW Individual headliner in Anthracite.** The A-, B-, C-, and D-pillar trim, sunblinds and roof handles also come in a sophisticated black finish (standard with X5 M50d).



□ **Harman Kardon surround sound system** with 600 watt digital amplifier, vehicle-specific equalising and loudspeakers with chrome detailing.



□ **Rear-seat entertainment Professional** includes a Blu-ray player and two separate 10.2" colour screens that can be tilted. It can be used to operate the navigation system or surf the internet while driving (with a mobile phone contract). Features remote control and ports for MP3 players, game consoles and headphones (can also be used with wireless headphones).



■ **Functional bookmarks** enable you to save and access frequently used items such as telephone numbers, navigation destinations and radio stations. A total of eight direct menu control buttons are conveniently positioned in the centre console.



■ **Automatic air conditioning with 2-zone control** features separate air volume and temperature controls for the driver and front passenger. Includes microfilter, fogging sensor, automatic air recirculation (AAR), as well as the stationary cooling and residual heat functions.

□ **Automatic air conditioning with 4-zone control** (shown here), same features as the 2-zone automatic air conditioning, plus additional air vents in the B-pillars and separate controls and screen in the rear for individual adjustment of the rear climate.



■ The **Lights package** includes numerous **LED lights** and lends the interior an elegant, relaxed ambience. The “welcome” lights create a carpet of light in front of the vehicle, leading into a well-balanced lighting design with indirect and direct light sources in blue, white and orange.



□ **Bang & Olufsen High End Surround Sound System** includes 16 loudspeakers with a 1,200 W output. The Dirac Dimensions signal processing adds to the exceptional acoustics. The sound system includes the “Studio” and “Expanded” options, as well as illumination of the retractable central speaker and both front tweeters.



□ **Panorama glass roof**, electric, with slide and lift functions, a wind deflector and a comfort opening function via the car's remote control.

¹ In Black with Amaro Brown, Nutmeg or Criollo Brown upholstery.
In Scotch dark with Smoke White or Taupe upholstery.

Optional and standard equipment vary according to country.

Standard / Optional equipment.



□ **Comfort seats** for driver and front passenger including Active headrests, can be electrically adjusted in various ways. The top part of the backrest, the backrest width, thigh support and headrest height can be individually adjusted. The seats also feature lumbar support and a memory function for the driver and front passenger.



□ **Comfort seats in the rear¹** feature particularly comfortable upholstery and can be individually adjusted in numerous ways. The two outer seats can be reclined by ten degrees in six stages. In addition, the comfort seats can be moved fore-and-aft by 80 millimetres in two sections (60:40 split), enabling you to increase the size of the luggage compartment or create more legroom as required. The rear seat backrest can also be completely folded down in a 40:20:40 split.



□ A **third row of seats¹** includes two individual fold-down seats facing the direction of travel, enabling the interior space to be used more flexibly. To facilitate entry, the second row can be folded down using the Easy Entry Function (rear comfort seats are standard as part of this option). In addition, a centre console with two cup holders is included, as well as additional heating for the third row footwells (not available in conjunction with the Alcantara/leather combination upholstery or Twill cloth).



■ **Rear seat backrest** (can be folded down in a 40:20:40 split) for more transport options and a customisable seat and luggage compartment configuration, as well as a rear centre armrest with two cup holders.



■ **Luggage compartment partition net** can be secured behind the second row of seats and prevents objects from falling forward into the passenger area if the driver has to brake hard.



□ **Sport seats** for driver and front passenger provide optimum lateral support with higher side bolsters and manually adjustable thigh support. The fore-and-aft position, as well as the seat angle and headrest height, can all be electronically adjusted. (Standard with M50d and the M Sport package.)



■ **Standard seats** for the driver and front passenger with electrically adjustable seat height and backrest angle as well as manual adjustment of the lengthways seat position and headrest height.



□ **Seat heating** for the driver and front passenger makes it possible to heat the seat surfaces and backrests in three levels (standard with xDrive50i and M50d).



□ The **electrical seat adjustment** makes it particularly convenient and easy to adjust the driver and front passenger seats. Thanks to a memory function, personal settings relating to the driver seat and exterior mirror can be restored at any time, at the push of a button. (standard with xDrive50i, xDrive40d and M50d).



□ **Active seat ventilation, front,** provides added comfort with air vents in the seat surfaces and backrests.



□ **Storage compartment package** includes two 12 V sockets, a sunglasses compartment on the interior mirror and a storage compartment in the rear centre armrest. The luggage compartment comes with two cargo rails, four fastening points, tensioning straps left/right, a flexible net with hooks on both sides, multi-purpose hooks and a net on the side wall.



■ **Storage options** in the front and rear doors, storage compartment with a fold-down lid to the left of the steering wheel, glove compartment, compartment for storing keys, compartment with a two-part lid under the front centre armrest, as well as a storage tray¹ under the floor of the luggage compartment.

¹ Not available with the X5 xDrive40 iPerformance.

Optional and standard equipment vary according to country.

Standard / Optional equipment.



■ **Ski and snowboard bag Pro¹** for clean and safe transportation of up to four pairs of skis or three snowboards with two people comfortably seated in the rear. The bag can be removed easily and used outside of the vehicle. When not in use, it can be stored in the sleeve and kept under the luggage compartment floor to save space (not available in conjunction with the third row of seats).



□ **Sunblinds** for the rear side windows that can be moved up and down manually. For protection against intense sunlight, as well as increased privacy.



■ **Four cupholders**, two in the centre console with a sliding cover and two in the rear centre armrest.
 □ The **smoker's package** includes a cigarette lighter and a removable ashtray in the front centre console.



■ **Bottle holders** for storing 1.5-litre bottles in the front side pockets and 1-litre bottles in the rear side pockets.



□ **Comfort Access** makes it possible to open all of the doors and the luggage compartment without using the key. Also includes vicinity lighting in the front and rear exterior door handles.

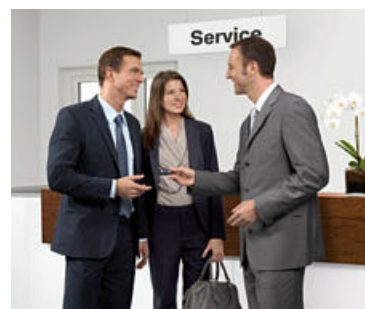

□ **BMW Service Inclusive.** Service costs are another area where your BMW Service partner can offer you an intelligent solution. With BMW Service Inclusive, routine maintenance service will be provided at no extra cost for the agreed duration or mileage. For more information visit www.bmw.com/ServiceInclusive



□ **BMW Welt.** Picking up a car at BMW Welt ranks as one of the best moments for any driver. Make this day into an unforgettable one with a comprehensive program tailored to you. Find out more at www.bmw-welt.com

¹ Not available with X5 xDrive40e.

Optional and standard equipment vary according to country.

BMW M Performance accessories*.

Choosing a BMW means opting for outstanding sportiness, dynamics and innovative vehicle technologies – in other words, values that accept no compromises. And values that you can take to an even higher level thanks to the BMW M Performance accessories product line. A line comprising a huge array of technical and design components from the fields of aerodynamics, suspension, drive systems and cockpit design, all developed with a single goal in mind – to give you an even more exhilarating experience of supreme dynamics. After all, BMW M Performance

accessories were developed for people who are inspired by ground-breaking technology and want the world to know. Your BMW Service partner will be happy to inform you about the entire range of BMW M Performance accessories and also has a special catalogue waiting for you. For more information, visit

www.bmw.com/accessories



21" BMW M Performance light alloy wheels Double-spoke style 310 M.



BMW M Performance exterior mirror caps in Carbon.



BMW M Performance rear flap and BMW M Performance rear diffuser in Carbon.



BMW M Performance II Alcantara steering wheel.



BMW M Performance gear lever trim made of carbon fibre.



BMW M Performance stainless steel footrest, BMW M Performance stainless steel pedal pad.



BMW M Performance front grille in black, BMW M Performance exterior mirror caps in carbon fibre, BMW M Performance front splinter in carbon fibre, BMW M Performance foil for side sills, 21" BMW M Performance light alloy wheels Double-spoke style 599 M bicolour, BMW M Performance 19" blue braking system.

* May not be available in all countries. Please consult your BMW partner.

		xDrive35i	xDrive50i	sDrive25d	xDrive25d	xDrive30d	xDrive40d	M50d	xDrive40e iPerformance
--	--	-----------	-----------	-----------	-----------	-----------	-----------	------	---------------------------

Weight									
Unladen weight EU ¹	kg	2105	2250	2070	2115	2145	2185	2265	2305
Max. permitted weight	kg	2785	2930	2750	2795	2825	2865	2945	2980
Permitted load	kg	715	715	715	715	715	715	715	750
Permitted trailer load, unbraked ⁵	kg	750	750	750	750	750	750	750	750
Permitted trailer load, braked, max. 12% gradient ⁵ /max. 8% gradient ⁵	kg	3500/3500	3500/3500	2700/2700	2700/2700	3500/3500	3500/3500	3500/3500	2700/2700
Luggage compartment capacity min.–max.	l	650–1870	650–1870	650–1870	650–1870	650–1870	650–1870	650–1870	500–1720

Engine ^{2,3}									
Cylinders/valves		6/4	8/4	4/4	4/4	6/4	6/4	6/4	4/4
Capacity	cc	2979	4395	1995	1995	2993	2993	2993	1997
Max. output/engine speed	kW (hp)/ rpm	225 (306)/ 5800–6400	330 (450)/ 5500–6000	170 (231)/ 4400	170 (231)/ 4400	190 (258)/ 4000	230 (313)/ 4400	280 (381)/ 4000–4400	180 (245)/ 5000–6500
Max. torque/engine speed	Nm/ rpm	400/ 1200–5000	650/ 2000–4500	500/ 2000–3000	500/ 2000–3000	560/ 1500–3000	630/ 1500–2500	740/ 2000–3000	350/ 1250–4800

Power transmission									
Drive configuration		All-wheel	All-wheel	Rear wheel	All-wheel	All-wheel	All-wheel	All-wheel	All-wheel
Standard		8-speed Steptronic	8-speed Steptronic	8-speed Steptronic	8-speed Steptronic	8-speed Steptronic	8-speed Steptronic	8-speed Steptronic	8-speed Steptronic

Performance									
Top speed	km/h	235	250 ⁶	220	220	230	236	250 ⁶	210
Top speed, electric	km/h	–	–	–	–	–	–	–	120 ⁶
Acceleration 0–100 km/h	s	6.5	4.9	7.7	7.7	6.8	5.9	5.3	6.8

Fuel consumption ^{2,3}									
Urban	l/100 km	11.2–11.3	12.9–13.0	5.9	6.2	6.7–6.8	6.8	7.2	–
Extra-urban	l/100 km	6.9	7.7–7.8	4.9–5.0	5.2–5.3	5.5	5.5–5.6	6.2	–
Combined	l/100 km	8.5	9.6–9.7	5.3–5.4	5.6	5.9–6.0	6.0	6.6	3.3–3.4
CO ₂ emissions	g/km	197–199	224–226	139–141	146–148	156–158	157–159	173	77–78
Tank capacity approx.	l	85	85	85	85	85	85	85	85

Wheels									
Tyre dimensions		255/55 R 18 V	255/50 R 19 W	255/55 R 18 V	255/55 R 18 V	255/55 R 18 V	255/55 R 18 V	255/50 R 19 W/ 285/45 R 19 W	255/55 R 18 V
Wheel dimensions		8.5 J x 18	9 J x 19	8.5 J x 18	8.5 J x 18	8.5 J x 18	8.5 J x 18	9 J/10 J x 19	8.5 J x 18
Material		light alloy	light alloy	light alloy	light alloy	light alloy	light alloy	light alloy	light alloy

eDrive system output									
Peak output/engine speed	kW (hp)/rpm	–	–	–	–	–	–	–	83 (113)/3170
System output	kW (hp)	–	–	–	–	–	–	–	230 (313)
System torque	Nm	–	–	–	–	–	–	–	450

High-voltage battery capacity									
Battery type/net battery capacity	kWh	–	–	–	–	–	–	–	9.2
Electric range (NEDC) ⁷	km	–	–	–	–	–	–	–	31
Charge time ⁸ (with household socket/ BMW i Wallbox Pure/Pro)	h	–	–	–	–	–	–	–	3.8/2.8

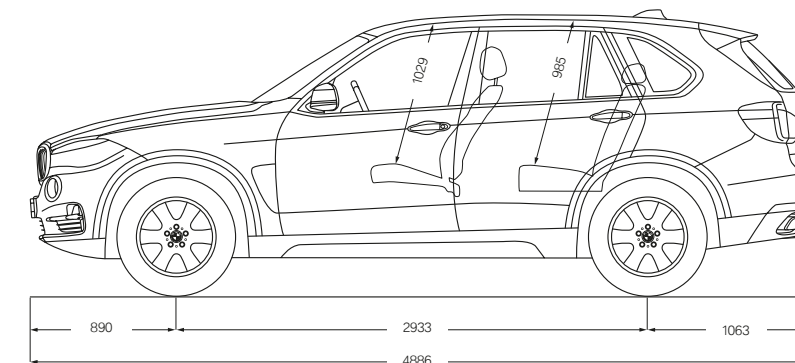
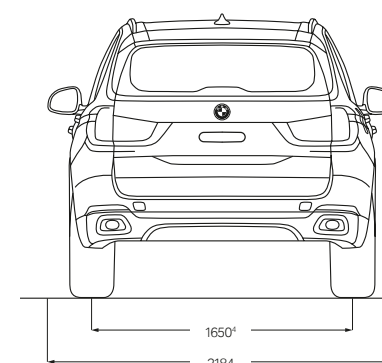
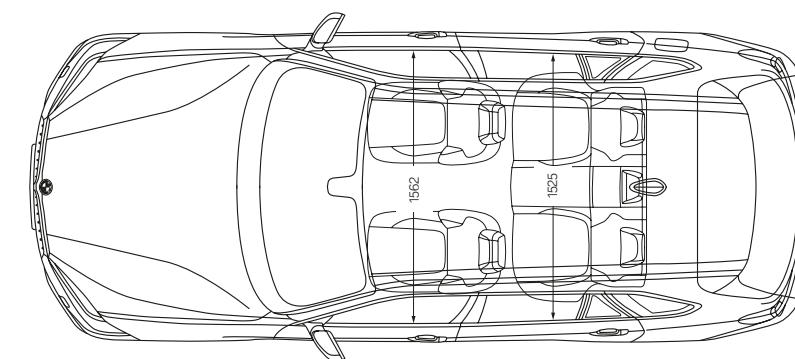
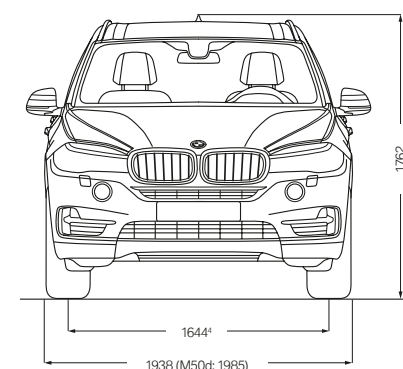

All dimensions in the technical drawings are given in millimetres. Height including roof aerial.

¹ The figure quoted includes a 90% full tank, 68 kg for the driver and 7 kg for luggage. Unladen weight applies to vehicles with standard equipment. Optional equipment will increase this figure.

² BMW recommends the use of RON 95 super unleaded petrol. Unleaded fuels 91 RON and higher with a maximum ethanol content of 10% (E10) may also be used. Output and fuel consumption figures apply to RON 98 fuel. All diesel models are designed for use with sulphur-free diesel petrol.

³ All engines comply with the EU6 emissions standard. Fuel consumption figures are determined according to the ECE driving cycle, which consists of approximately one-third urban traffic and two-thirds extra-urban driving (based on the distance covered). CO₂ emissions are measured in addition to fuel consumption. The fuel consumption figures are based on models with standard equipment. Optional equipment may increase these figures. Fuel consumption and CO₂ emissions are affected by the selected wheel and tyre sizes.

⁴ The BMW X5 xDrive50i has a track width of 1,640 mm at the front and 1,646 mm at the rear. The track width of the BMW X5 M50d is 1,662 mm at the front and 1,702 mm at the rear.

⁵ Only with factory-fitted tow bar, otherwise the max. trailer load is 2,700 kg / 140 kg tow bar download.

⁶ Electronically limited.

⁷ Range depends on various factors, in particular: personal driving style, road conditions, external temperature, heating/climate control, thermal pre-conditioning.

⁸ Dependent on local electricity infrastructure. Charge time refers to the time necessary to reach 100% of the maximum capacity.

WELL TAKEN CARE OF WITH BMW SERVICES:

When you buy a BMW, you can look forward to superb service and comprehensive customer care. For example, the **Condition Based Service** independently tracks both service fluid levels and the condition of parts subject to wear and then notifies you in the display when the vehicle requires servicing. So you only need to go to your BMW service partner when it's really necessary. When you do go, our

qualified BMW service specialists take care of your vehicle using the newest workshop technology and only **original BMW parts**. This service is available worldwide in more than 3,300 BMW service partner establishments in over 150 countries, to provide you with limitless driving pleasure.

BMW SERVICE.



BMW Service Packages*: Individual and stress-free, just for you. Individual, well-thought-out servicing solutions carefully tailored to you and your vehicle. With one-off, predictable costs, BMW Service Packages give you complete peace of mind, so you can enjoy owning a BMW to the very fullest. Whether it's fresh from the showroom or already well-travelled – there's a BMW Service Package for every phase of your vehicle's life. All bringing you maximum quality, expertise and value retention, always at reasonable, transparent rates. And always carefully tailored to you and your BMW. Find out just how stress-free truly individual service can be!

www.bmw.com/serviceinclusive



BMW Mobile Service*: This service is there for you day and night. As soon as you call, we spring into action, and take care of everything that may need doing after an accident or breakdown, with specially trained technicians working – on site or via telephone – to get your car back on the road. We offer comprehensive, country-specific mobility packages for breakdowns, and insurance that covers you in the event of an accident or theft. So if anything untoward does happen, simply call up the BMW accident hotline and we'll go to work. We'll take care of calling the emergency services, a tow truck, a replacement car, notifying your insurance company and much more. For further information please visit www.bmw.com



BMW TeleServices*: With Condition Based Service, you'll be automatically reminded of your next necessary service appointment on the vehicle screen. Provided you've consented, key vehicle data will be relayed to BMW automatically for analysis. Your assigned BMW service partner will access the information and contact you free of charge to make a service appointment as and when necessary. To access BMW Teleservices, the vehicle must be equipped with the optional Intelligent Emergency Call or ConnectedDrive Services. The service can be deactivated at any time you so desire, and you can change your service partner in the iDrive menu or ConnectedDrive portal. Find out more at www.bmw.com/teleservices

BMW FINANCIAL SERVICE.



BMW Financial Services*: Mobility solutions to meet your needs. BMW Financial Services provides you with attractive leasing, finance and insurance options. To find out more, see the price list or go to www.bmwfs.com. Your BMW partner will also be glad to draw up an individual offer for you in person.

THE BMW EXPERIENCE.



BMW TV*: www.bmw.tv enables you to experience the BMW brand in all its diversity. Features, portraits and background reports provide you with information on automobiles, innovations, sports and lifestyle topics.



BMW Driving Experience: The better you control your BMW, the more enjoyment you will derive from driving it. Use our training courses to learn for yourself what it means to reach a car's physical limits on various types of surfaces, and what you have to do to control your vehicle even in extreme situations. For further information please visit www.bmwdrivingexperience.com



BMW Welt: Picking up a car at BMW Welt has always ranked among the best moments for any driver. Turn this moment into one whole unforgettable day: experience the handover of your new BMW as just one part of a programme of activities perfectly tailored to your interests. At BMW Welt, the BMW Group plant, the BMW Museum, the BMW Group headquarters and the BMW Group Classic all combine to provide you with a great experience of an exciting history, a breathtaking present – and spectacular visions for the future. Find out more at www.bmw-welt.com/en



BMW Magazine: In BMW Magazine, experience the newest BMW models in front of stunning backdrops. Discover new design trends, travel destinations and the richness of modern life. Encounter people with visionary ideas who are changing the world. Find out more at www.bmw.com/magazine

* May not be available in all countries. Please consult your BMW partner.

SHAPING THE FUTURE – RESPONSIBLY.

In 2015, the BMW Group was once more listed in the Dow Jones Sustainability Index as the most sustainable automotive company worldwide. This makes BMW Group the only company in the automotive industry to be listed without interruption since the index was established. The development of efficient vehicle concepts and environmentally friendly production processes, including recycling, is an integral part of our philosophy. BMW EfficientDynamics and electric vehicles have enabled us to cut CO₂ emissions from our European new-vehicle fleet by more than 40% since 1995. We have also reduced the amount of resources used in production, such as water and energy, by 34% between 2006 and 2015, with a reduction to 45% of previous levels aimed at for 2020. In terms of other resources (such as volatile organic compounds, process wastewater and waste) our 45% target was met in 2014, and we will continue to work on further improvement. Production at our engine plant in Steyr has been waste-water free since 2007. And of course, at the end of its service life, every one of our vehicles can be easily and economically recycled. To return your end-of-life vehicle, please contact your BMW partner. For more information on this issue please visit our website.

www.bmw.com/EfficientDynamics
www.bmwgroup.com/responsibility
www.bmw.com/recycling

More about BMW



The Ultimate Driving Machine

www.bmw.co.za

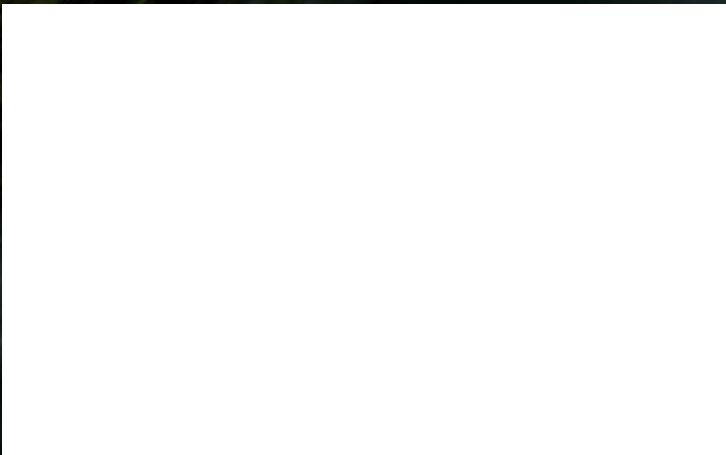

This brochure describes the model, features and configuration options (standard and optional) available in vehicles delivered by BMW AG for the South African market. There may be deviations from the features and configuration options described in this brochure, in terms of the standard and optional equipment. For more precise information about country-specific vehicle versions, please contact your local BMW dealership or visit www.bmw.co.za.

Subject to change in design and equipment. E&OE.

© BMW AG, Munich/Germany. No reproduction in whole or in part without the written approval of BMW AG, Munich.

27/03/2017

4 11 005 225 23 2 2016 BM. Printed in Germany 2016.

