

Audi

2017

A4



Audi



Audi

2017

A4



Audi







**Brilliance is both the inspiration
and the result of our design.**



Light without compromising power. Edgy without compromising refinement. Smart without compromising the fun of the drive. The all-new Audi A4 packs an incredible amount of intelligent features and available advanced technologies into a refined chassis and a brilliantly designed ergonomic cabin. And under the hood, the 2.0-liter TFSI® engine and S tronic® dual-clutch transmission creates a vehicle that proves you can have brains and brawn.

Swipe to start Design >

You'd think eternal beauty is a myth.

Design

Engineering

Performance

Technology

Safety

Visualizer
Equipment
Accessories

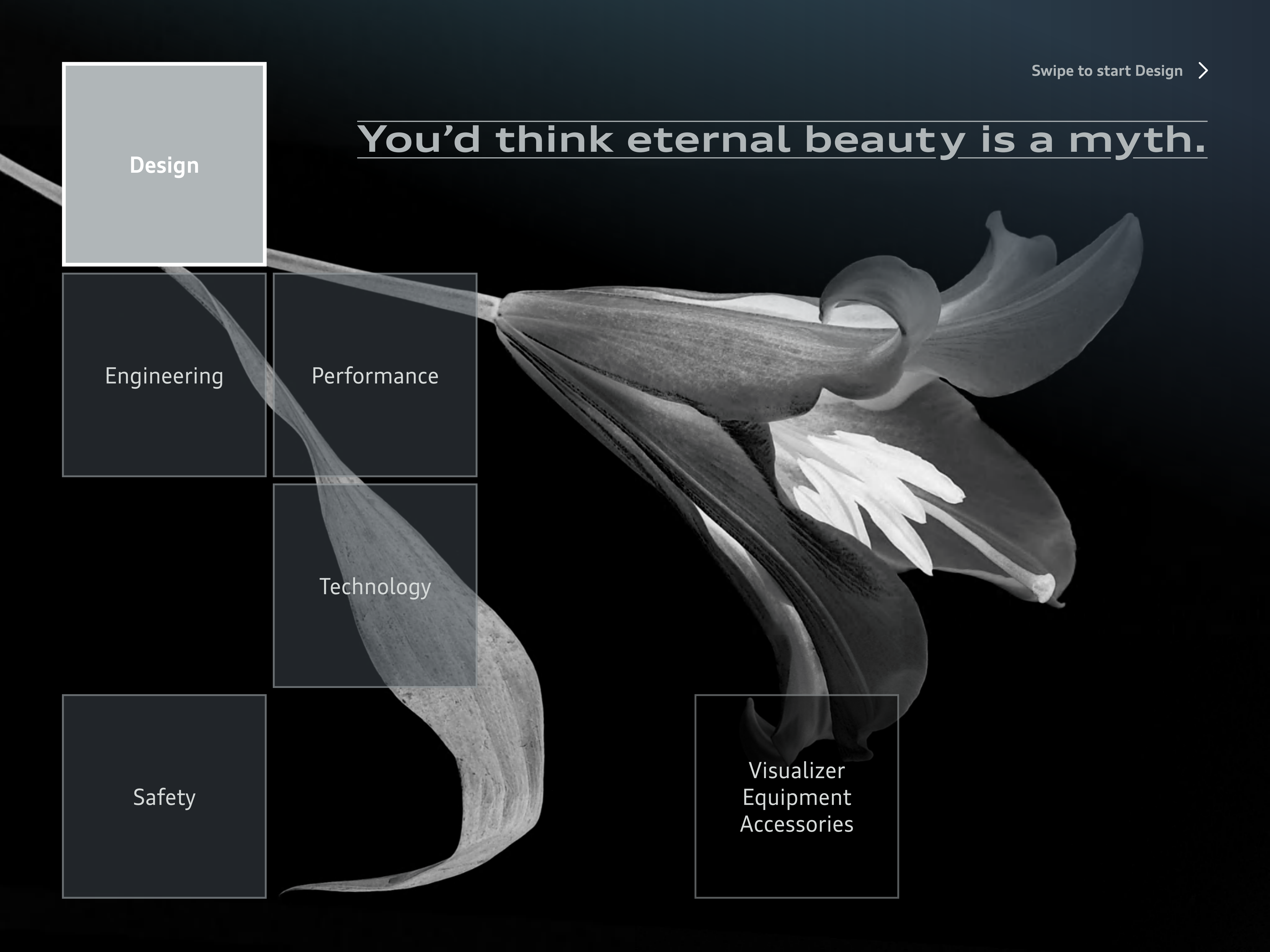

A lot of work went into our effortless style.



From first sight, the all-new Audi A4 offers our traditional distinction and style. But take a closer look and you will notice its bolder shape, lower stance and more aggressive body lines. The design is illuminated by the styling of enhanced, available full LED headlights, standard dynamic LED taillights and iconic Singleframe® grille, creating something both effortless and intensively crafted.

Swipe to scroll >



A lot of work went into
our effortless style.



A lot of work went into
our effortless style.

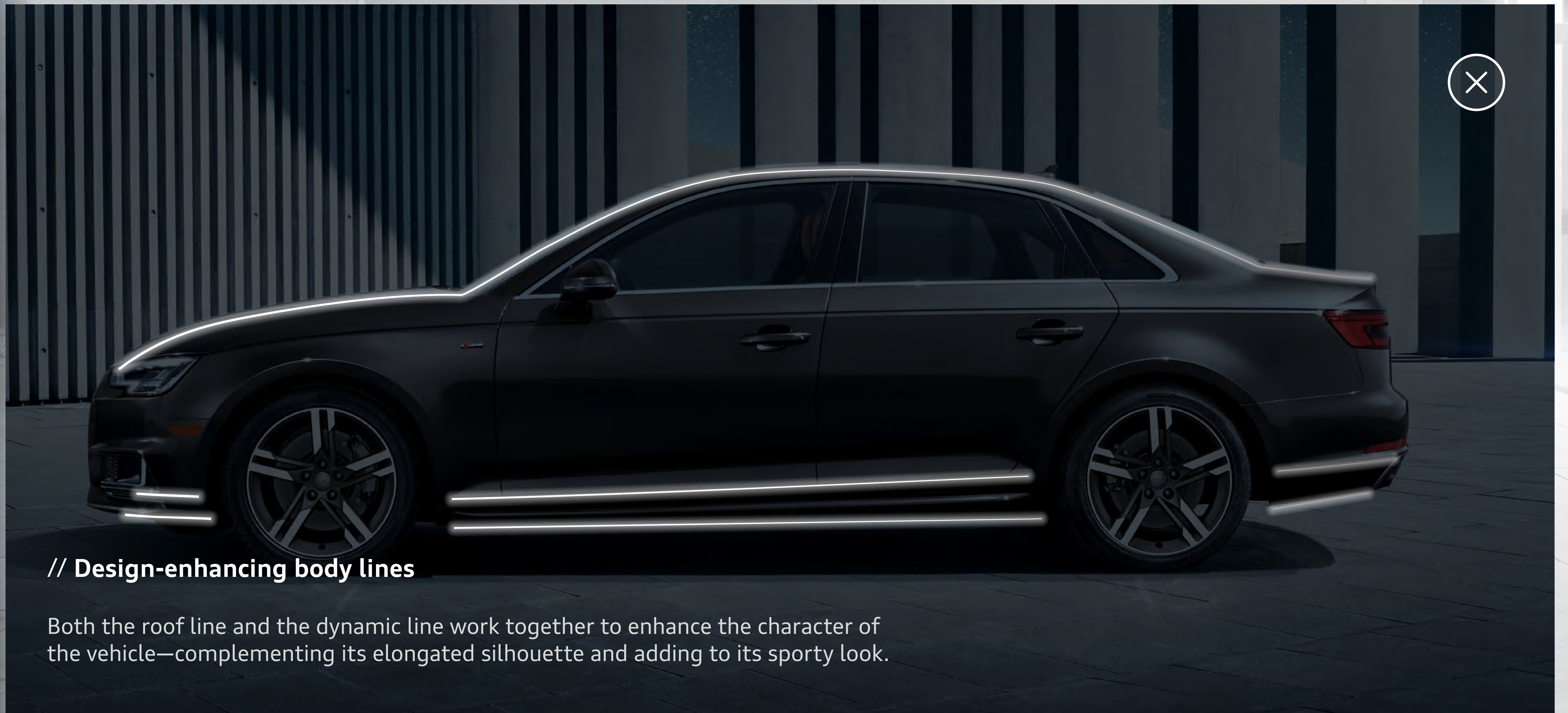

// Design-enhancing body lines

Both the roof line and the dynamic line work together to enhance the character of the vehicle—complementing its elongated silhouette and adding to its sporty look.

A lot of work went into
our effortless style.



A lot of work went into
our effortless style.



// **Bold rear design**

The shoulder line and its crisp tapering continues, wrapping around the rear of the vehicle for a unified look. It is met with the brilliance of standard LED taillights with dynamic turn indicators, creating a minimalist expression with a maximum impression.

It's all in the details.



// Audi Singleframe® grille

The newly designed Audi Singleframe® grille surrounds the iconic Four Rings on the front fascia with a wide, diamond-inspired shape that reflects road-gripping capability of the A4.



// Integrated wrap-around hood seam

Clean. Modern. Authoritative. The wrap-around hood seam accentuates the vehicle's width and demonstrates its performance and design pedigree.

Build your 2017 A4 [↗](#)

Sometimes it's good to have something just pass you by.

Since air resists the movement of a vehicle passing through it, the engine power required to surpass drag needs to increase. By aerodynamically optimizing the design of the Audi A4, we've increased performance without overworking the engine.

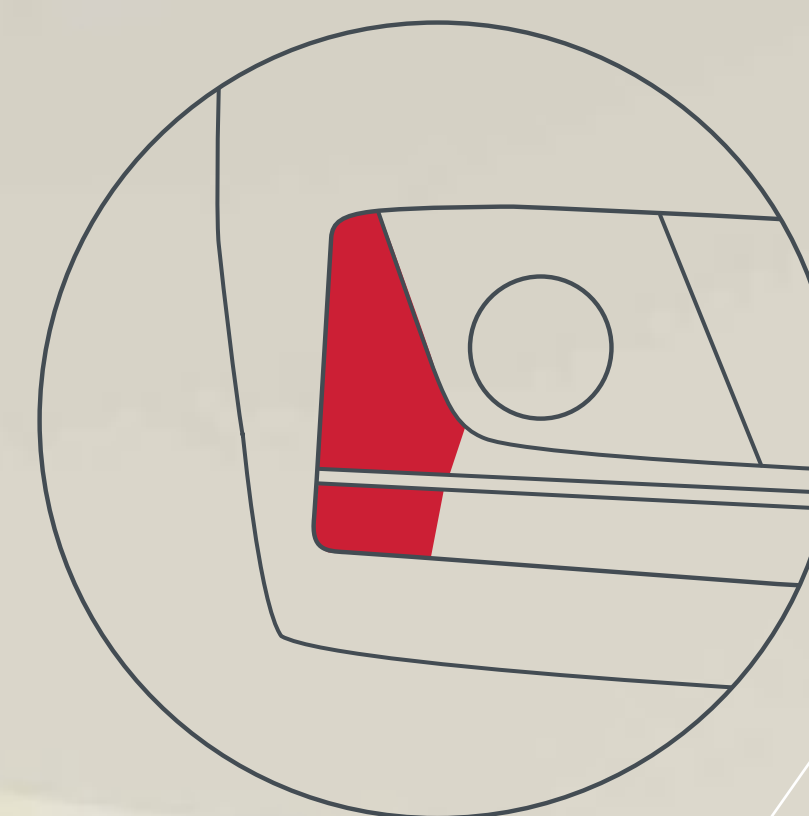

Front bumper air intake

The outer sections of the air intakes have additional openings that direct the air into the wheel arches.



Sometimes it's good to have something just pass you by.

Since air resists the movement of a vehicle passing through it, the engine power required to surpass drag needs to increase. By aerodynamically optimizing the design of the Audi A4, we've increased performance without overworking the engine.

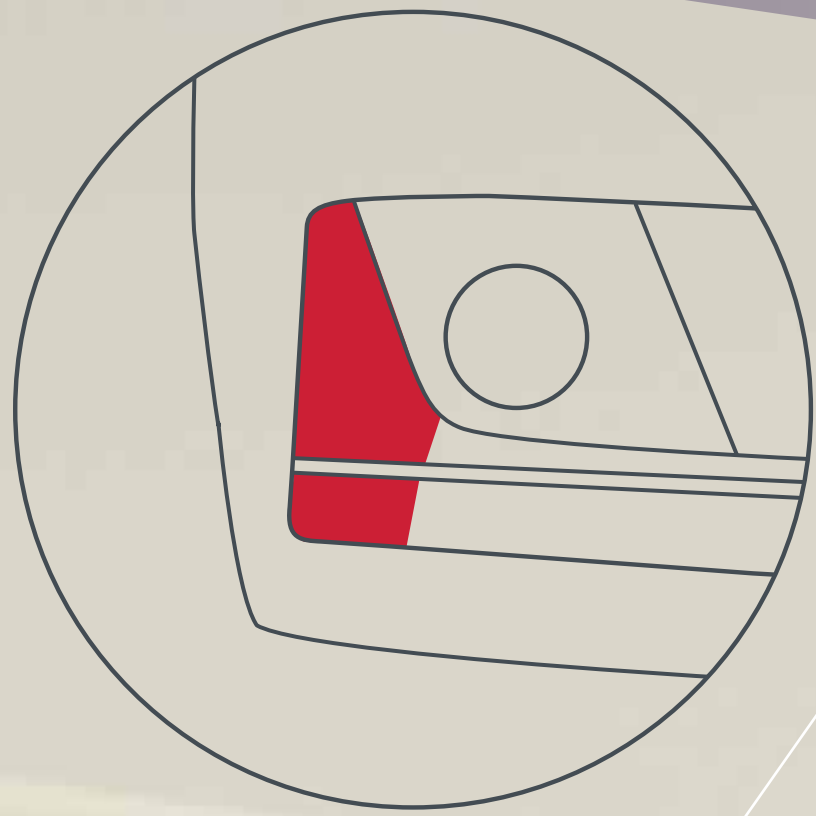

Front bumper air intake

The outer sections of the air intakes have additional openings that direct the air into the wheel arches.

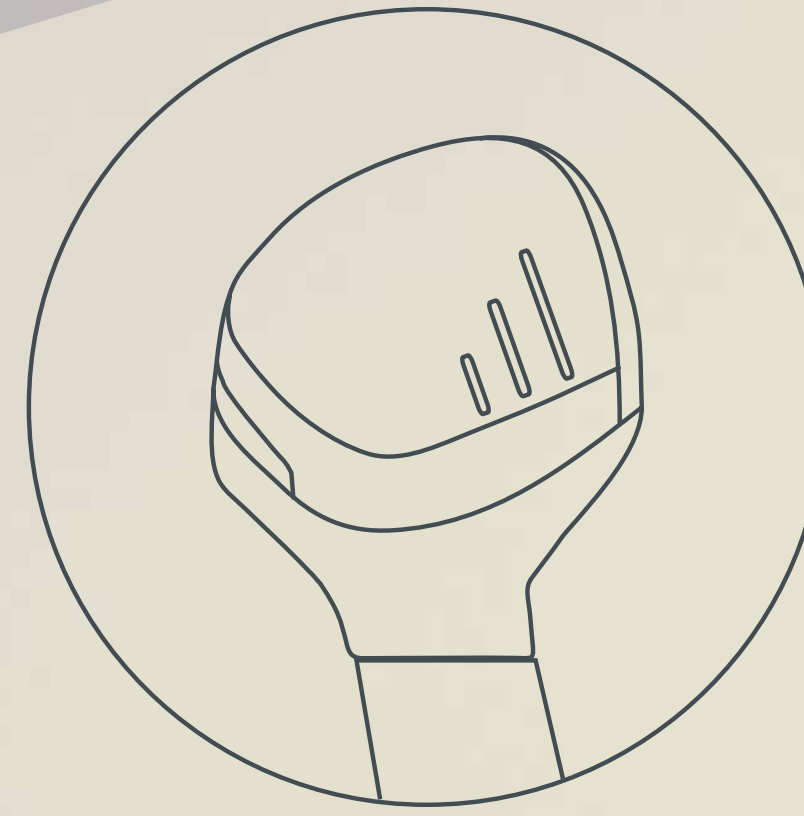

Exterior side mirrors

The exterior side mirror housings have been moved to the door and include additional air ribs. This helps reduce turbulence and air release on the vehicle and adds to its sporty design.

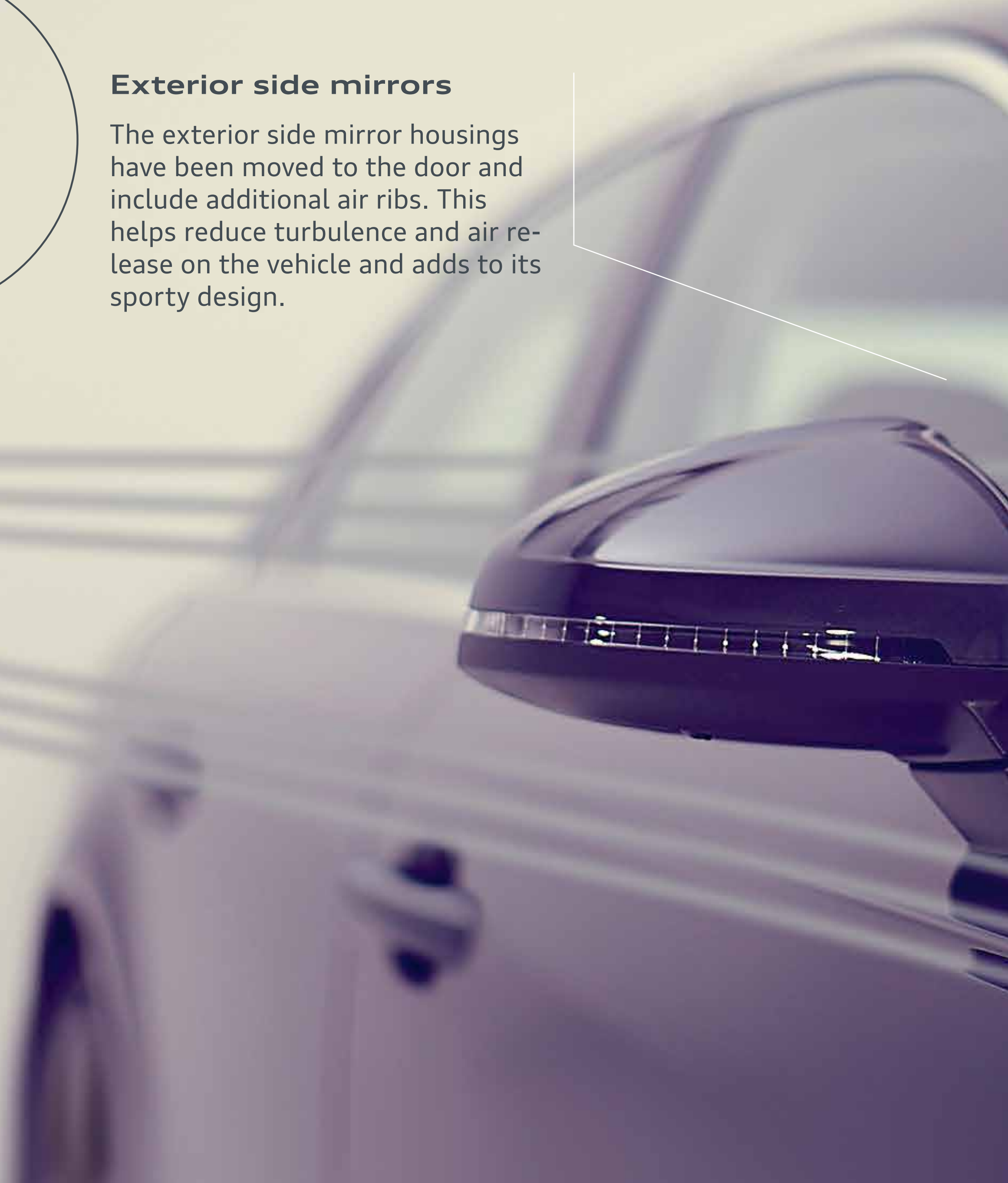

Sometimes it's good to have something just pass you by.

Since air resists the movement of a vehicle passing through it, the engine power required to surpass drag needs to increase. By aerodynamically optimizing the design of the Audi A4, we've increased performance without overworking the engine.



Exterior side mirrors

The exterior side mirror housings have been moved to the door and include additional air ribs. This helps reduce turbulence and air release on the vehicle and adds to its sporty design.



Sometimes it's good to have something just pass you by.

Since air resists the movement of a vehicle passing through it, the engine power required to surpass drag needs to increase. By aerodynamically optimizing the design of the Audi A4, we've increased performance without overworking the engine.

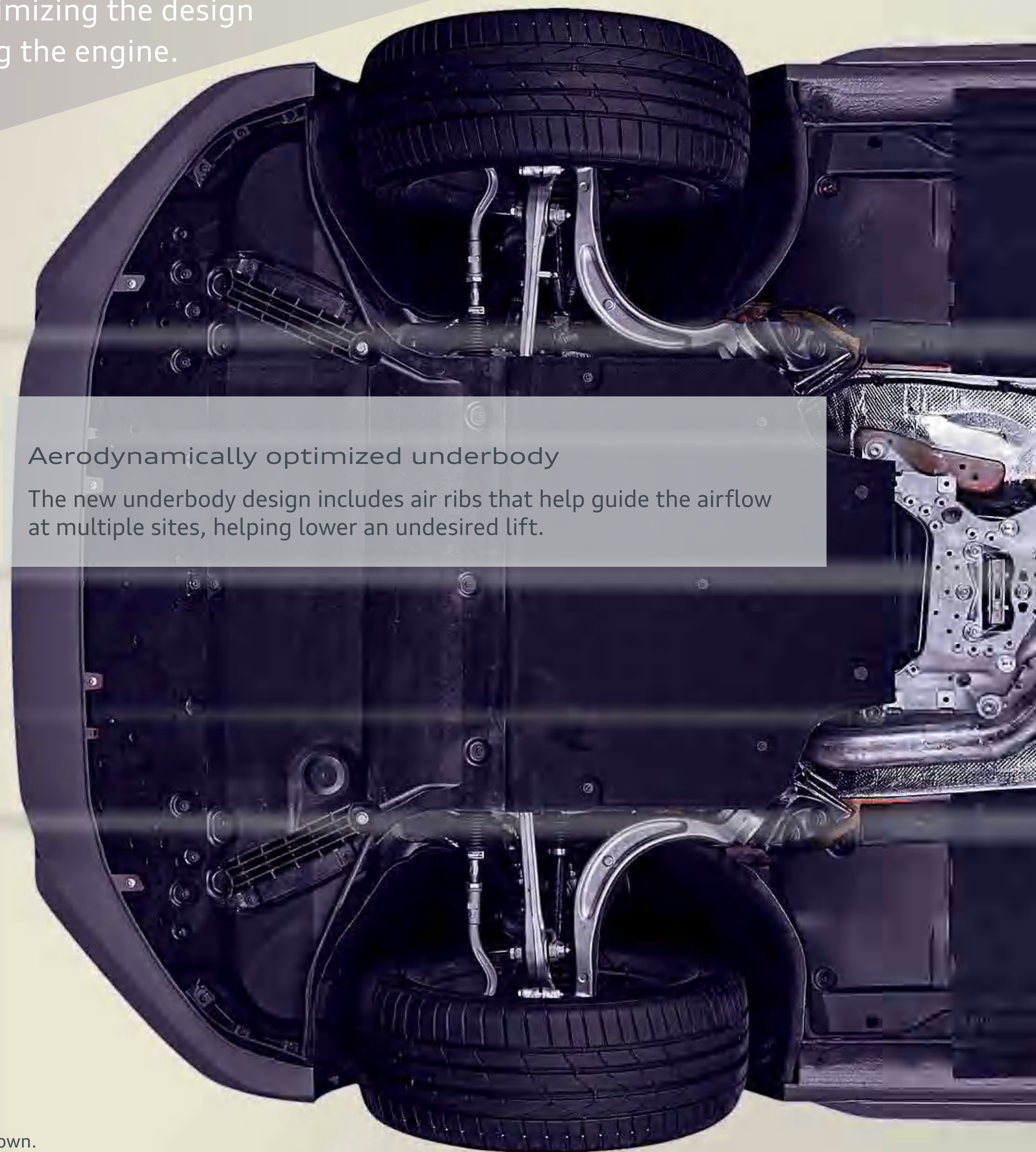

Aerodynamically optimized underbody

The new underbody design includes air ribs that help guide the airflow at multiple sites, helping lower an undesired lift.

European model shown.

Sometimes it's good to have something just pass you by.

Since air resists the movement of a vehicle passing through it, the engine power required to surpass drag needs to increase. By aerodynamically optimizing the design of the Audi A4, we've increased performance without overworking the engine.

Aerodynamically optimized underbody

The new underbody design includes air ribs that help guide the airflow at multiple sites, helping lower an undesired lift.

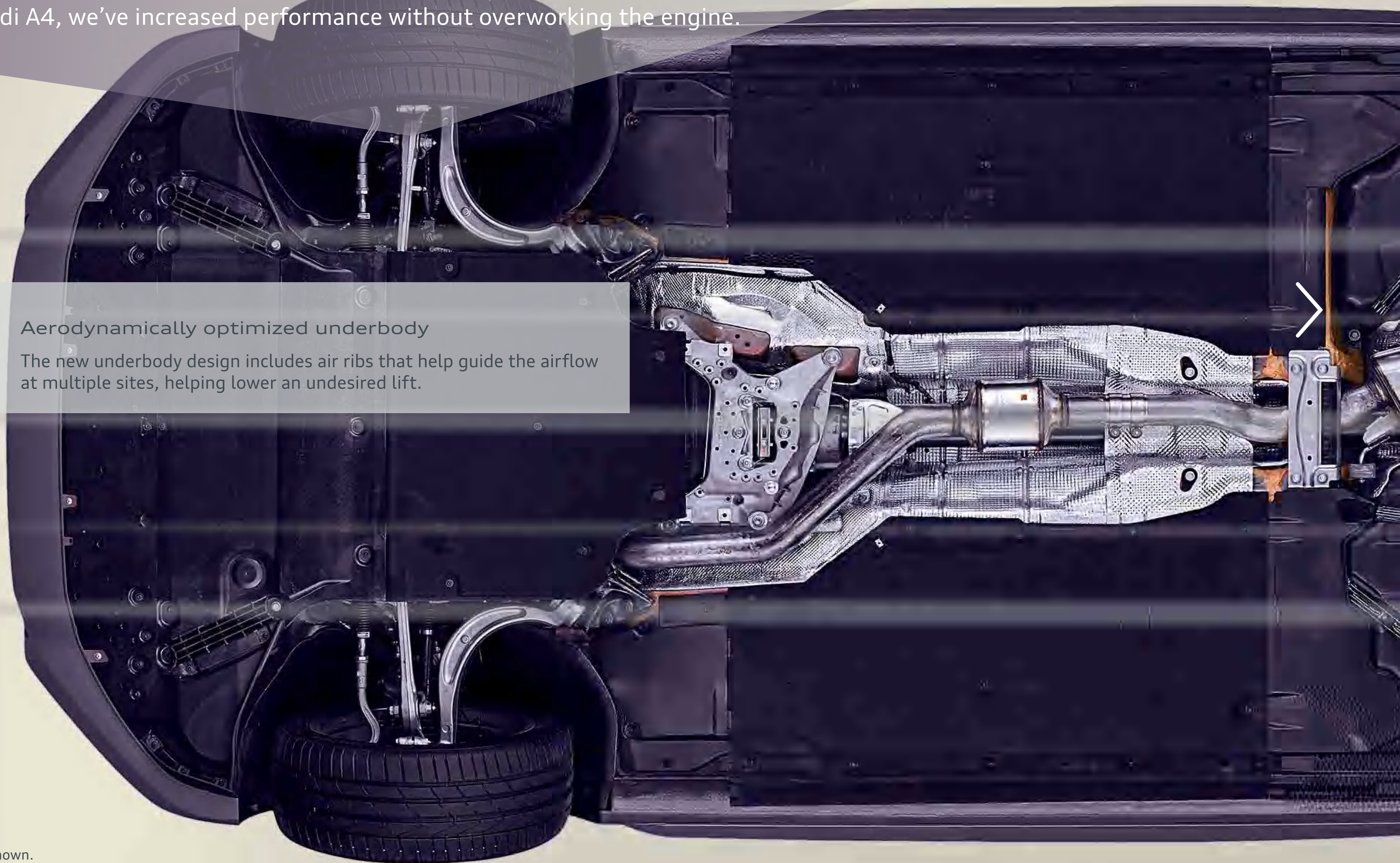

Sometimes it's good to have something just pass you by.

Since air resists the movement of a vehicle passing through it, the engine power required to surpass drag needs to increase. By aerodynamically optimizing the design of the Audi A4, we've increased performance without overworking the engine.

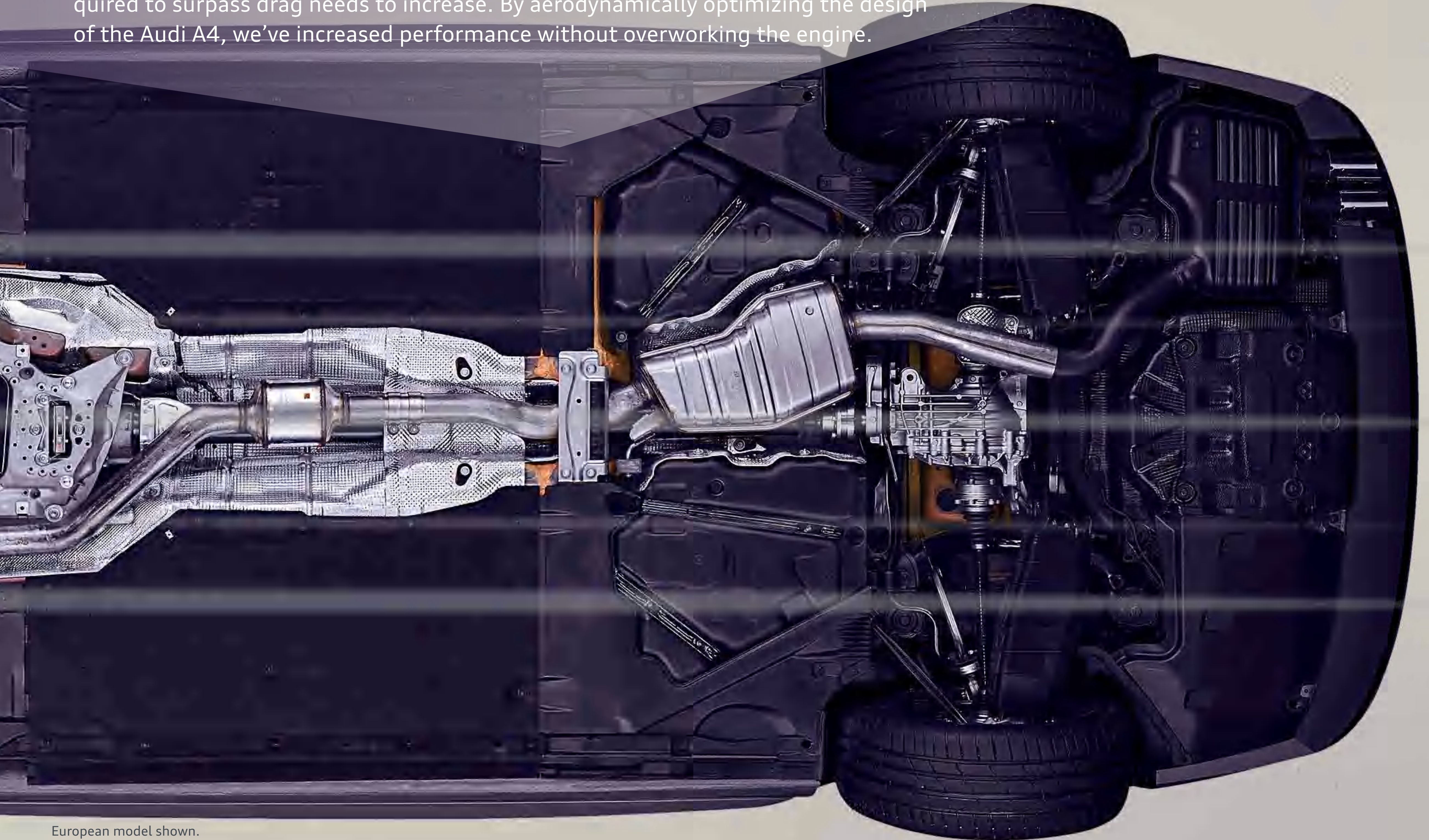

Go light to look deep.

The heart of our exterior design may be just through our eyes. Our iconic LED lighting technology provides efficient, long-life illumination and creates a distinctive, brilliant look that accentuates the width of the vehicle and is unmistakably Audi.





// Full LED headlights

Available full LED headlights provide daylight-like illumination, and the undercut design of the headlamps plays with elements of light and shadow to create a deep layer of brilliance. Add to that an LED daytime running light signature that forms a precise outline, creating a striking, unmistakable look.



// LED taillights

Standard LED taillights with rear fog lights add superior lighting performance to the rear. The new dynamic turn signals add to the brilliance of the design with a sweeping pattern of illumination.

Signs of a supple intelligence.



Signs of a supple intelligence.



// Driver-centric ergonomic wing design

Luxury and versatility intersect in a near-perfect ergonomic space where everything you need is easily visible and accessible. Elements such as the available Audi virtual cockpit to the MMI® display placement; to a yacht-style gear selector, all work harmoniously to help make your vehicle easy to operate.

[Find A Local Dealer ↗](#)



What you feel in here touches us.



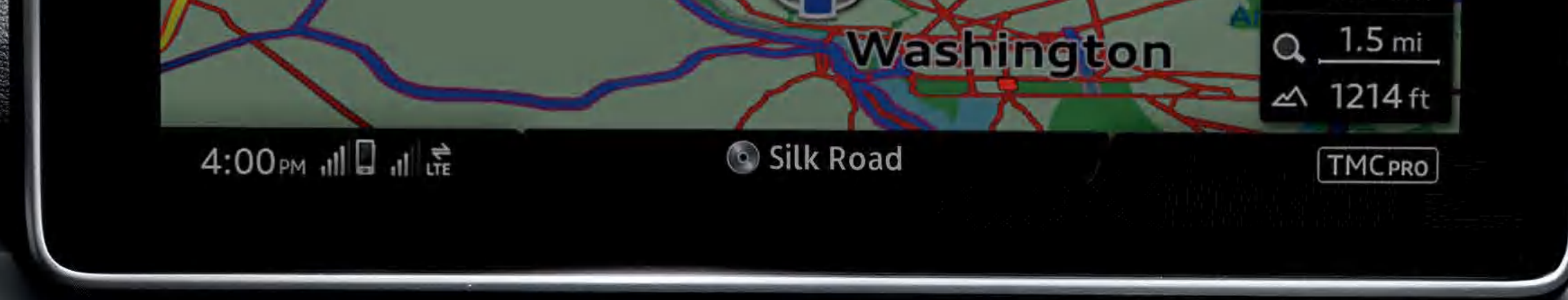

// Three-zone automatic climate control

Standard three-zone automatic climate control provides both front and rear passengers with the ability to dial in to their temperatures. Additionally, the horizontal air vent strip helps provide a natural airflow feeling—all controlled from an intuitive, climate control cluster with function keys that include haptic feedback.





// Heated and ventilated seats

Supple standard leather seating surfaces, available heated and ventilated front seats and available heated rear seats offer multiple levels of heating and cooling to help warm up or invigorate your body during nearly any road travel.



// Yacht-style gear selector

Designed to be natural and intuitive, the yacht-style gear selector allows you to rest your wrist easily while engaging the available MMI® touch handwriting-recognition system.



// Uniform climate control vent

A plush cabin is made even more comfortable with uniform climate control airflow. The newly designed vents help provide optimal air dispersion in the cabin, so nearly all of your passengers will feel increased comfort without sensing draft or temperature fluctuations.

Ambient, but not passive.

Individual. Attractive. Functional. Ambient LED interior lighting packages create a functional, reactive and beautifully lit cabin. The two sets of available interior LED contour and background lighting can be customized to adjust illumination based on Audi drive select mode or individual style.



Slide bar below to change lighting.



min

max



Ambient, but not passive.

Individual. Attractive. Functional. Ambient LED interior lighting packages create a functional, reactive and beautifully lit cabin. The two sets of available interior LED contour and background lighting can be customized to adjust illumination based on Audi drive select mode or individual style.



Slide bar below to change lighting.

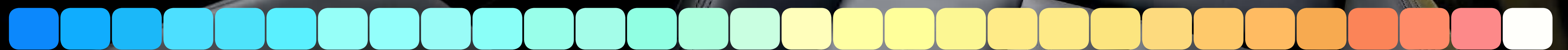

min

max

Ambient, but not passive.

Individual. Attractive. Functional. Ambient LED interior lighting packages create a functional, reactive and beautifully lit cabin. The two sets of available interior LED contour and background lighting can be customized to adjust illumination based on Audi drive select mode or individual style.



Slide bar below to change lighting.



min

max

Ambient, but not passive.

Individual. Attractive. Functional. Ambient LED interior lighting packages create a functional, reactive and beautifully lit cabin. The two sets of available interior LED contour and background lighting can be customized to adjust illumination based on Audi drive select mode or individual style.



Slide bar below to change lighting.

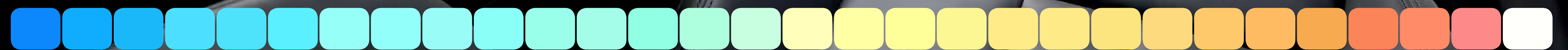

min

max





// Ambient LED interior lighting packages

The standard ambient LED interior lighting package allows you to illuminate and adjust the brightness of your cabin with White LED lighting. Additionally, the available ambient LED interior lighting plus package on the Prestige trim level, the driver can either use the three available preset color profiles (White, Maritime Blue and Impulse Red) or select up to 30 color settings for an added dimension of progressive opulence or adaptability within, via the Audi drive select modes.

// Interactive and individual modes

Up to five zones (Front, Footwell, Door, Overhead console and Contour lighting) can be customized via an Individual mode profile setting or controlled through a dynamic profile setting that adjusts illumination based on your Audi drive select mode.

// Vehicle exit assist

Through an available vehicle exit assist system in conjunction with available Audi side assist, an upper door inlay light guide illuminates as a warning if the driver or passenger attempts to open the door with an approaching vehicle or cyclist in its path.¹

[Search A4 Inventory ↗](#)

¹ The features discussed are not substitutes for attentive driving. See Owner's Manual for further details and important limitations.

Swipe to start Engineering >

How nature does the heavy lifting.

Design

Engineering

Performance

Technology

Safety

Visualizer
Equipment
Accessories

Lightweight that builds muscle.

32
lbs

5

13



Audi ultra® lightweight technology uses materials that are both lightweight and resilient, helping increase the structural strength of the vehicle while reducing mass. This results in greater agility, handling and enhanced efficiency.¹

We reduced up to 99 pounds to give you a more responsive drive.

up to
99
lbs

Baby Panda
~99 lbs



1. Based on EPA estimates. See www.fueleconomy.gov for details. Your mileage will vary and depends on several factors, including your driving habits and vehicle condition.

Swipe to start Performance >

How we continue to put control over horses.

Design

Engineering

Performance

Technology

Safety

Visualizer
Equipment
Accessories

252
horsepower



130
mph at top track speed¹

273
lb-ft torque

Plug into your power source.

Powerful. Dynamic. Advanced. The engaging performance of the powerful 2.0-liter TFSI® engine and S tronic® dual-clutch automatic transmission will leave you finding reasons to get back on the road.

Build your 2017 A4 [↗](#)

¹ Top track speed is electronically limited in the U.S. Always obey all speed and traffic laws.

252
horsepower



130
mph at top track speed¹

273
lb-ft torque

Plug into your power source.

Powerful. Dynamic. Advanced. The engaging performance of the powerful 2.0-liter TFSI® engine and S tronic® dual-clutch automatic transmission will leave you finding reasons to get back on the road.

1 Top track speed is electronically limited in the U.S. Always obey all speed and traffic laws.

82.5 mm

bore

x

92.8 mm

stroke

1,984 cc

engine displacement



9.6:1

compression ratio

2.0

-liter engine

// 2.0 TFSI® engine

The 2.0-liter DOHC engine produces 252 horsepower and 273 lb-ft of torque, and combines the Audi valvelift system, TFSI® direct injection and turbocharging technologies for great power and overall performance.

// S tronic® transmission

For the first time, the Audi A4 is equipped with a dynamic, seven-speed S tronic® dual-clutch transmission. Responsive and intelligently managed, the S tronic® gives the convenience of an automatic while providing faster shifting.

82.5_{mm}

bore

x

92.8_{mm}

stroke

1,984_{cc}

engine displacement



9.6:1

compression ratio

2.0

-liter engine

// 2.0 TFSI® engine

The 2.0-liter DOHC engine produces 252 horsepower and 273 lb-ft of torque, and combines the Audi valvelift system, TFSI® direct injection and turbocharging technologies for great power and overall performance.

// S tronic® transmission

For the first time, the Audi A4 is equipped with a dynamic, seven-speed S tronic® dual-clutch transmission. Responsive and intelligently managed, the S tronic® gives the convenience of an automatic while providing faster shifting.

quattro®. Independent grip. Intelligently applied.

The legendary available quattro® all-wheel drive system splits torque between the front and rear axles to help promote dynamic handling and distribute torque to where it's needed most.



TAP ANY CORNER

Stay nimble.



Power distribution

Under normal driving conditions, the center differential splits torque at a ratio of 40:60, front to rear, but as conditions change, the ratio is enhanced to help maximize grip, providing more traction and a more confident drive.

dent grip.

ed.

lits torque between
and distribute torque



TAP ANY CORNER

Stay nimble.



Power distribution

Under normal driving conditions, the center differential splits torque at a ratio of 40:60, front to rear, but as conditions change, the ratio is enhanced to help maximize grip, providing more traction and a more confident drive.

Stay strong.

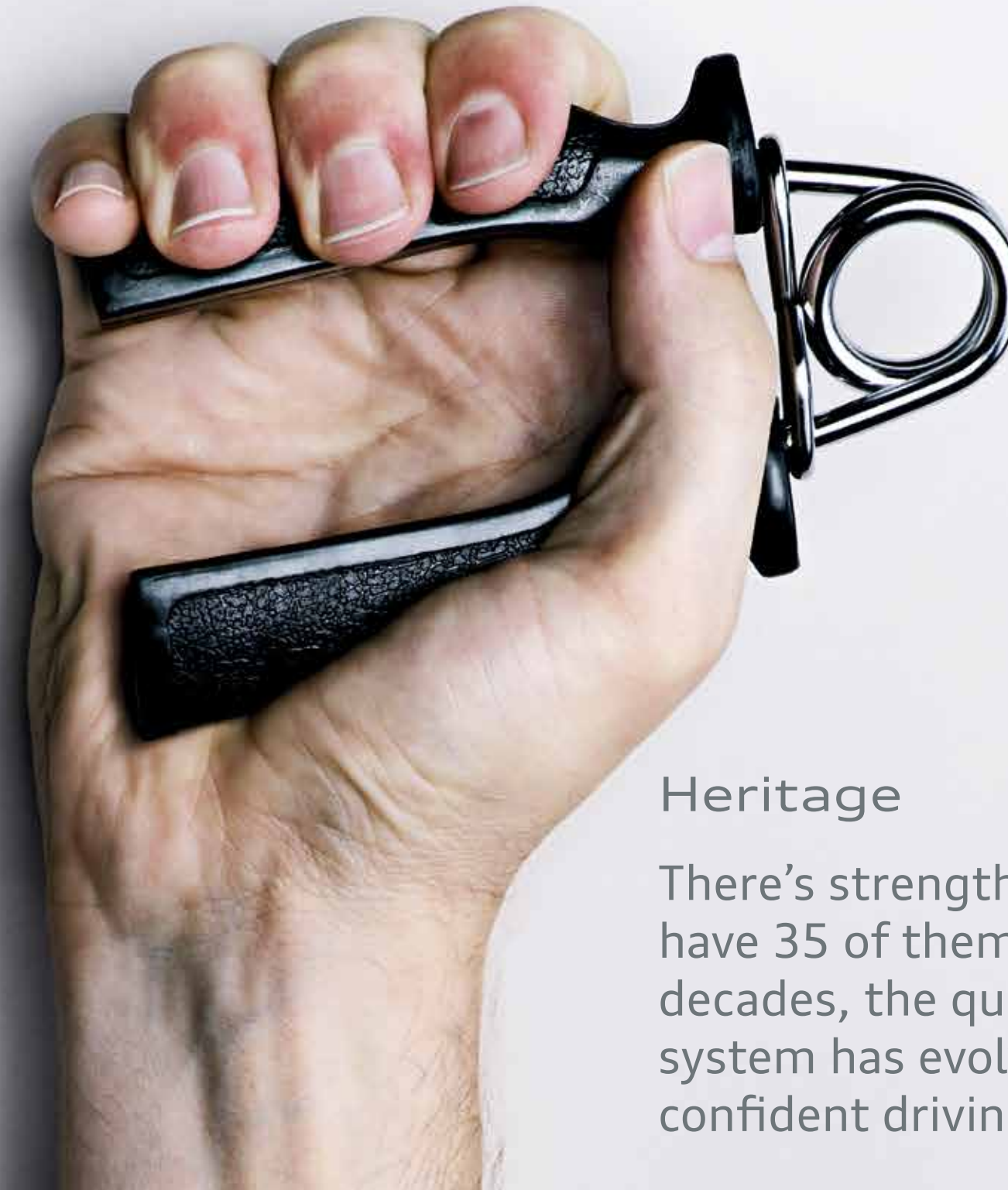

Heritage

There's strength in numbers. And we have 35 of them. Over the past three decades, the quattro® all-wheel drive system has evolved to help give you a confident driving experience.



TAP ANY CORNER

Stay nimble.

Stay strong.

Power distribution

Under normal driving conditions, the center differential splits torque at a ratio of 40:60, front to rear, but as conditions change, the ratio is enhanced to help maximize grip, providing more traction and a more confident drive.

Torque vectoring

A finely calibrated Electronic Stability Control system with integrated torque vectoring logic helps keep the vehicle headed in the direction you intended, managing torque application laterally across the front and rear axle for enhanced handling characteristics.

Finely calibrated grip.

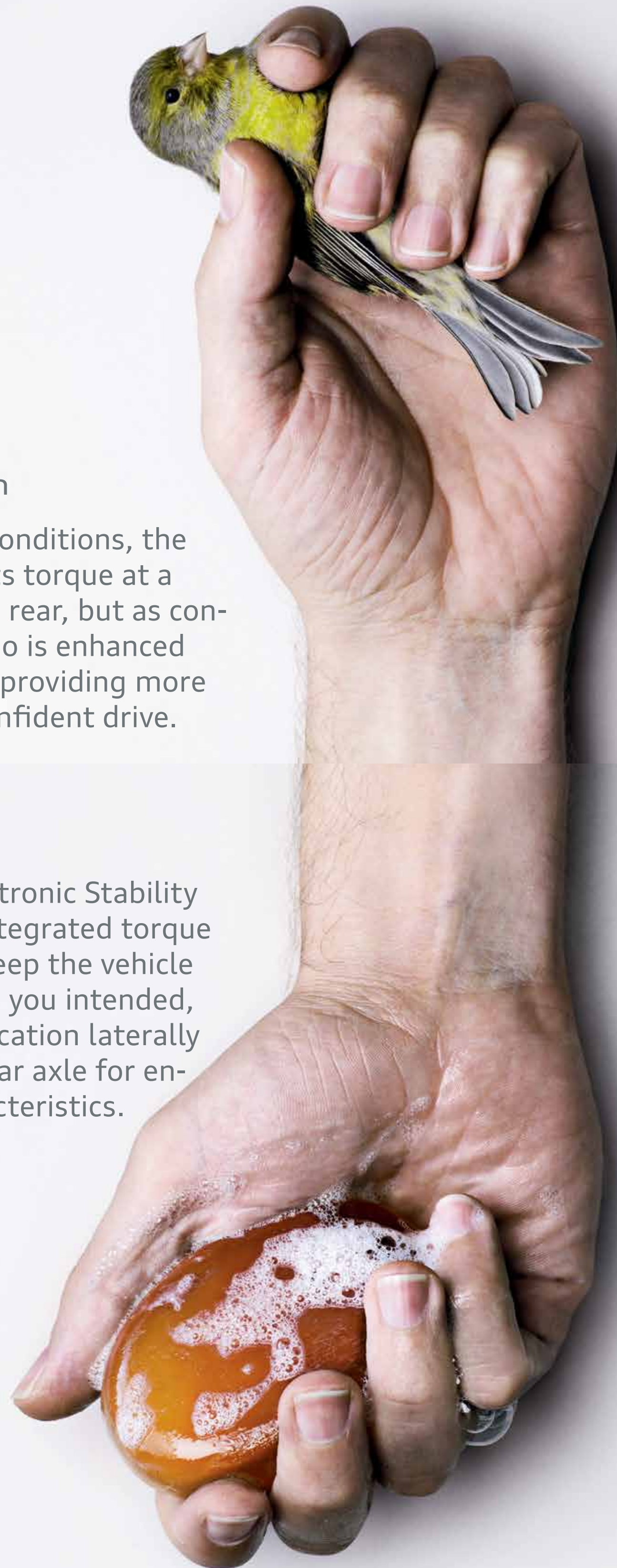

Heritage

There's strength in numbers. And we have 35 of them. Over the past three decades, the quattro® all-wheel drive system has evolved to help give you a confident driving experience.



CORNER

Stay nimble.

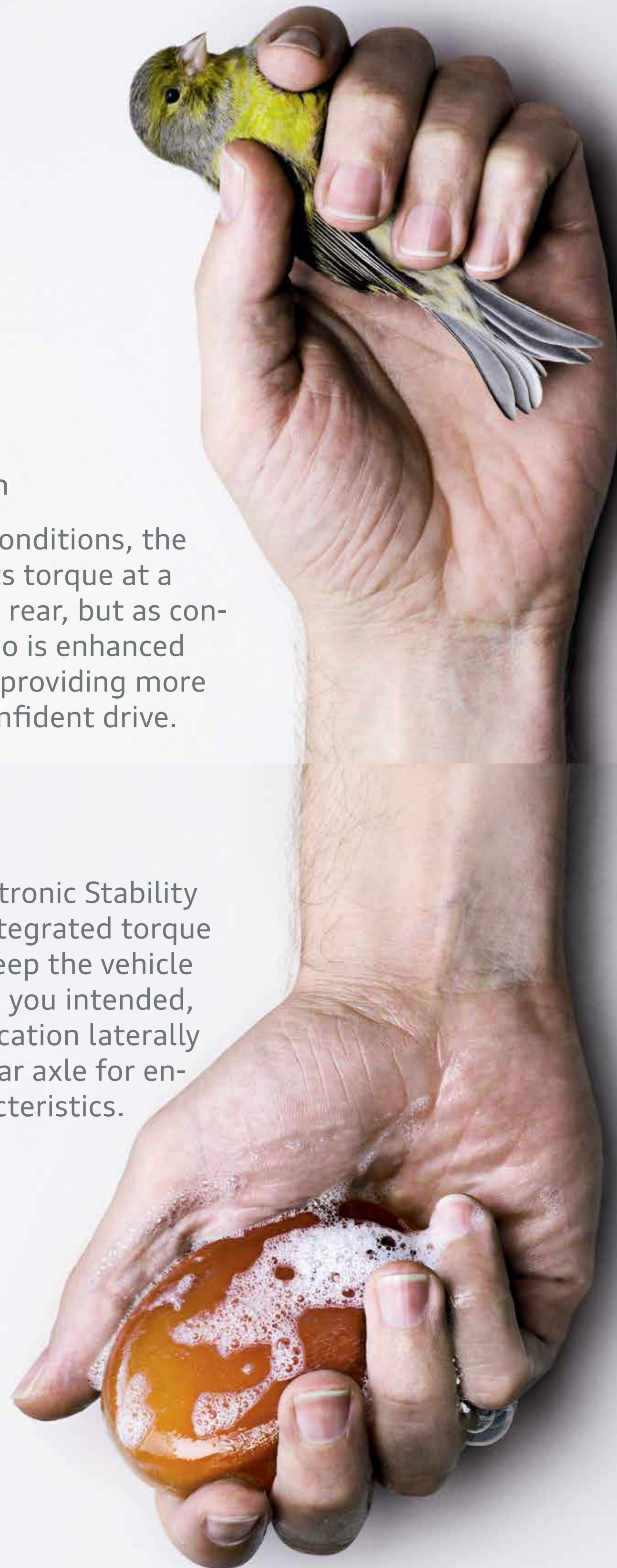

Power distribution

Under normal driving conditions, the center differential splits torque at a ratio of 40:60, front to rear, but as conditions change, the ratio is enhanced to help maximize grip, providing more traction and a more confident drive.

Torque vectoring

A finely calibrated Electronic Stability Control system with integrated torque vectoring logic helps keep the vehicle headed in the direction you intended, managing torque application laterally across the front and rear axle for enhanced handling characteristics.

Finely calibrated grip.

Stay strong.



Heritage

There's strength in numbers. And we have 35 of them. Over the past three decades, the quattro® all-wheel drive system has evolved to help give you a confident driving experience.

Quick calibration

The available quattro® all-wheel drive system recalibrates itself quickly to efficiently distribute force.

That is as solid as it feels.



European model shown.



European model shown.



European model shown.



European model shown.



Five-link rear suspension

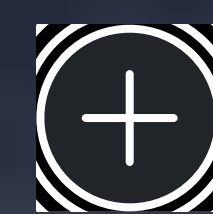

Five-link front suspension

This is our power stance.

Sporty performance meets luxurious ride comfort with the all-new suspension components and revised kinematics. New five-link front and rear independent suspension systems, available adaptive damping suspension and redesigned aluminum components work in tandem through ultra[®] lightweight technology to create responsive tuning and reduce unsprung weight.



// Five-link front suspension

The five-link front suspension allows for optimal absorption of forces. The forged-aluminum mounts are designed to be rigid in the lateral direction and more compliant in the longitudinal direction. Both work together for a blend of comfort and agility.

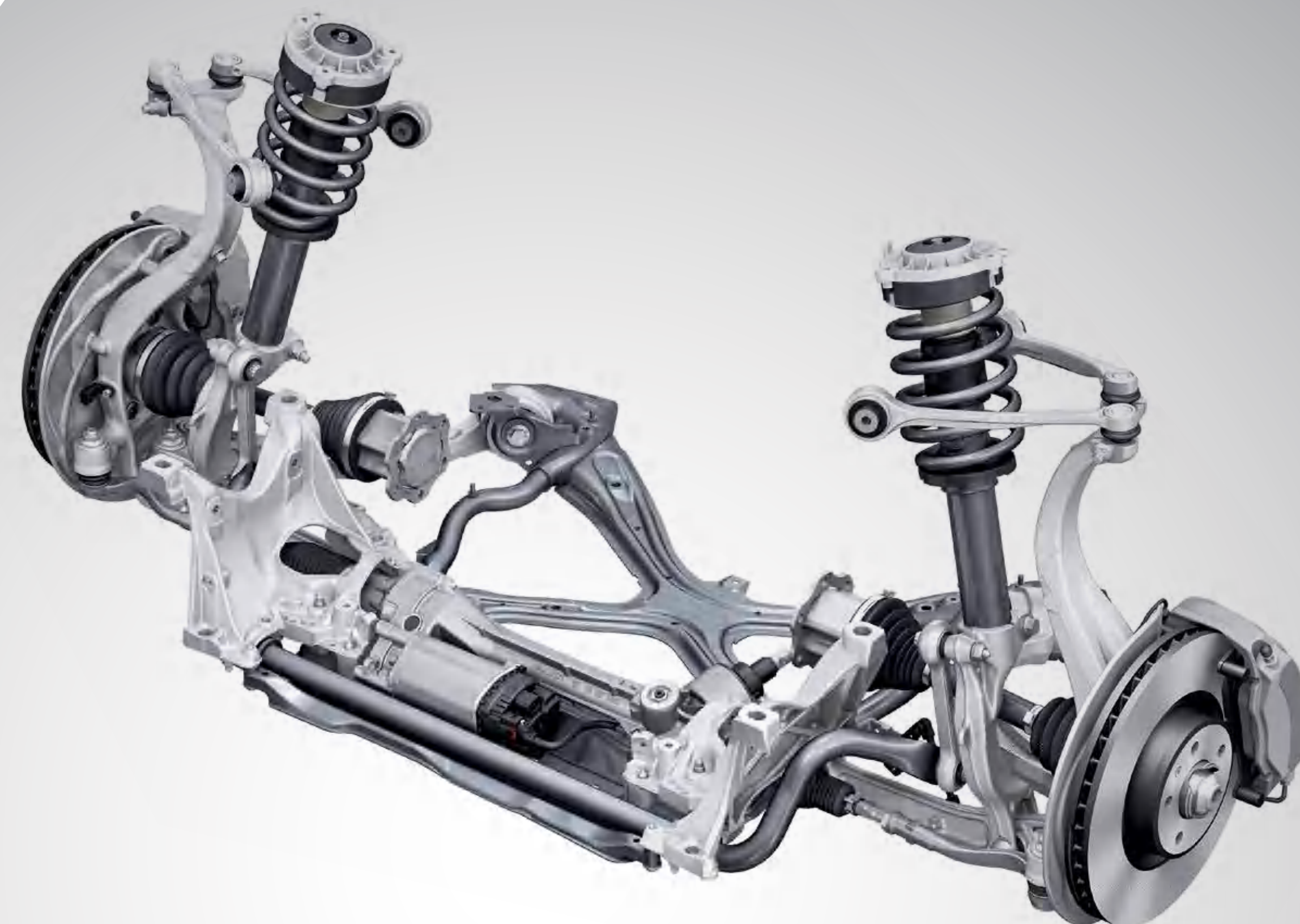



// Five-link rear suspension

To help ensure ride comfort, the rear subframe mounting is hydraulically dampened to help reduce the road harshness you feel.

Swipe to start Technology >

Design

Engineering

Performance

Technology

Safety

Visualizer
Equipment
Accessories

We see a better
connection in our future.

A high-angle, slightly blurred photograph of a busy city street intersection. In the foreground, a crosswalk with white stripes is visible. Several yellow taxis are driving through the intersection. Pedestrians are walking across the street. In the background, there are buildings, streetlights, and more people. The overall scene is a typical urban environment.

What we do is make sense of this, so you don't have to.

Complex systems helping to solve simple problems. Our comprehensive portfolio of available driver assistance technologies help enhance your drive, and hopefully, make it a little easier to navigate.¹

9681135

¹ The features discussed are not substitutes for attentive driving. See Owner's Manual for further details, and important limitations.

// Traffic jam assist¹

At speeds of up to 40 mph, this available innovation can help assist the driver with steering, throttle and braking input while moving in congested driving conditions. Using radar and ultrasonic sensors, traffic jam assist can help guide you through traffic with gentle steering interventions while keeping a proper distance from other vehicles.

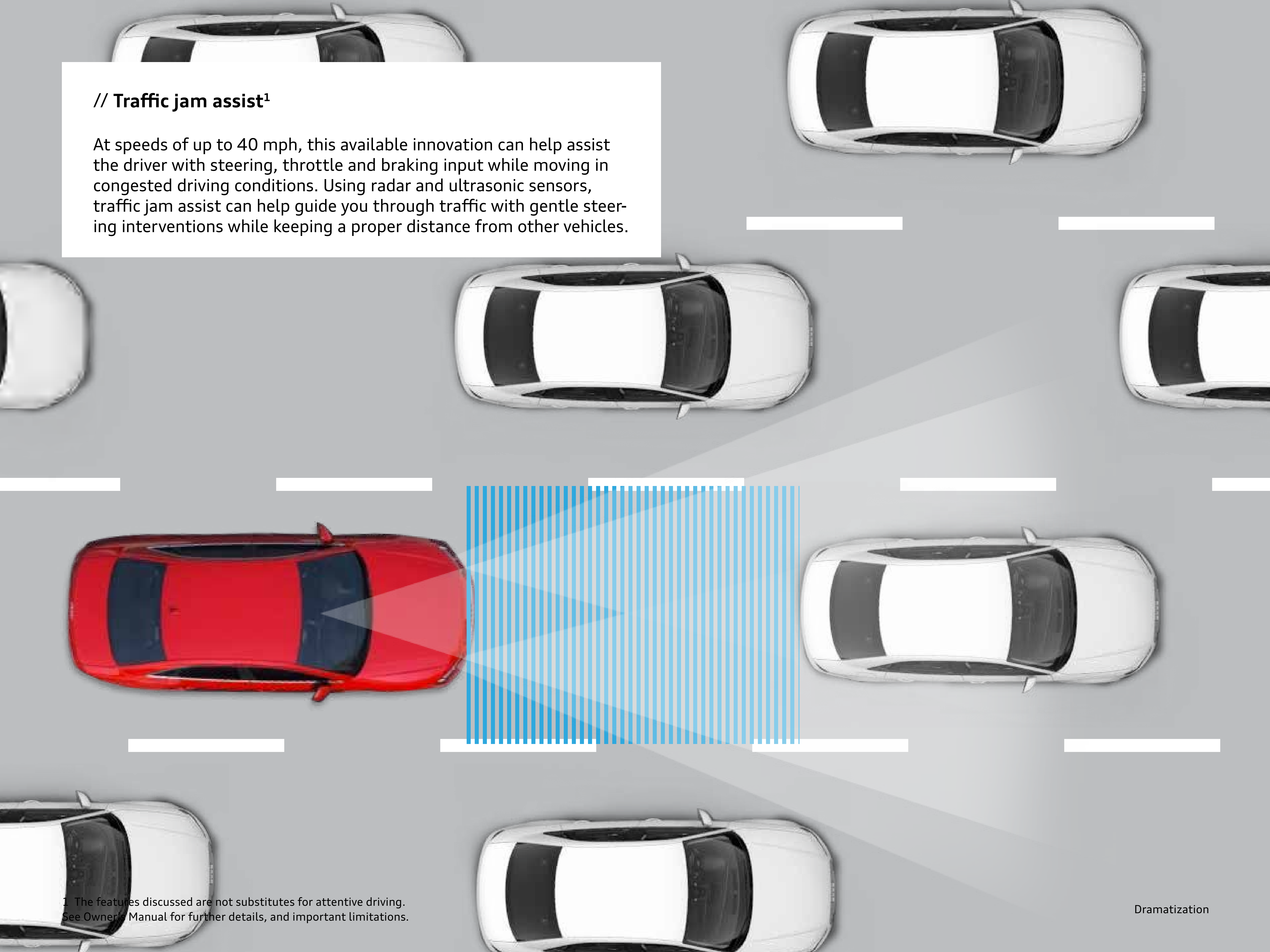

¹ The features discussed are not substitutes for attentive driving. See Owner's Manual for further details, and important limitations.

// Traffic jam assist¹

At speeds of up to 40 mph, this available innovation can help assist the driver with steering, throttle and braking input while moving in congested driving conditions. Using radar and ultrasonic sensors, traffic jam assist can help guide you through traffic with gentle steering interventions while keeping a proper distance from other vehicles.

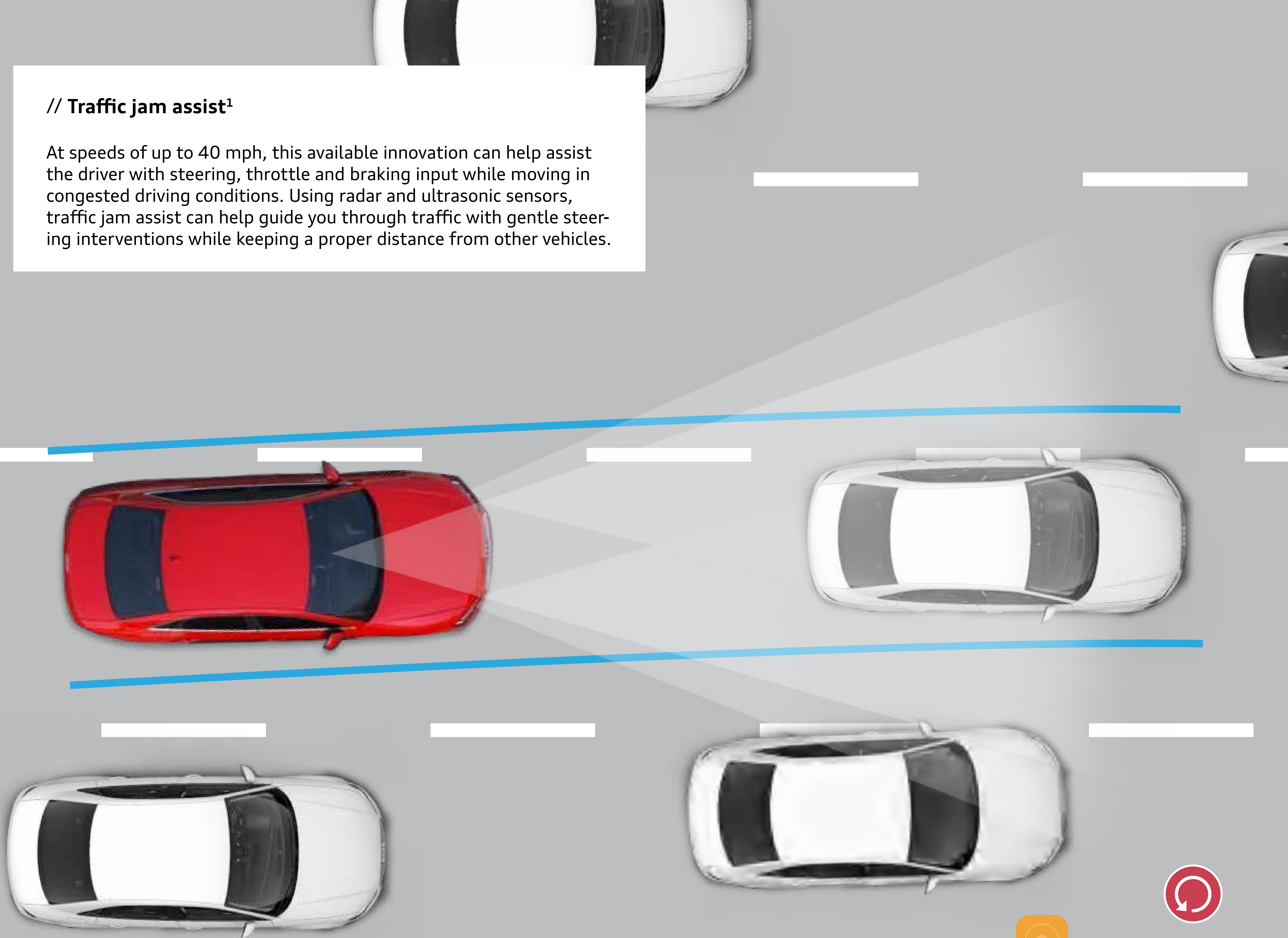

¹ The features discussed are not substitutes for attentive driving. See Owner's Manual for further details, and important limitations.





Dramatization

Rear cross traffic alert

Audi pre sense® city

Turn assist

Available radar and ultrasonic sensors in the Audi A4 help detect crossing traffic behind you and helps warn you if a vehicle is crossing your projected path while reversing. The warning is audible, visually shown on the MMI® display and, if necessary, felt with a brake jolt.¹

[Schedule a Test Drive ↗](#)

¹ The features discussed are not substitutes for attentive driving. Please see your owner's manual for further details and important limitations.



Dramatization

Rear cross traffic alert

Audi pre sense® city

Turn assist

This standard innovation monitors vehicles and pedestrians ahead to help prevent collisions. It uses the front camera on the windshield to sense potential obstacles. If there is an imminent threat, it alerts the driver first with a warning—then if no action is taken—gives a warning jolt and finally, activates automatic emergency braking if needed.¹

[Schedule a Test Drive ↗](#)

¹ The features discussed are not substitutes for attentive driving. Please see your owner's manual for further details and important limitations.

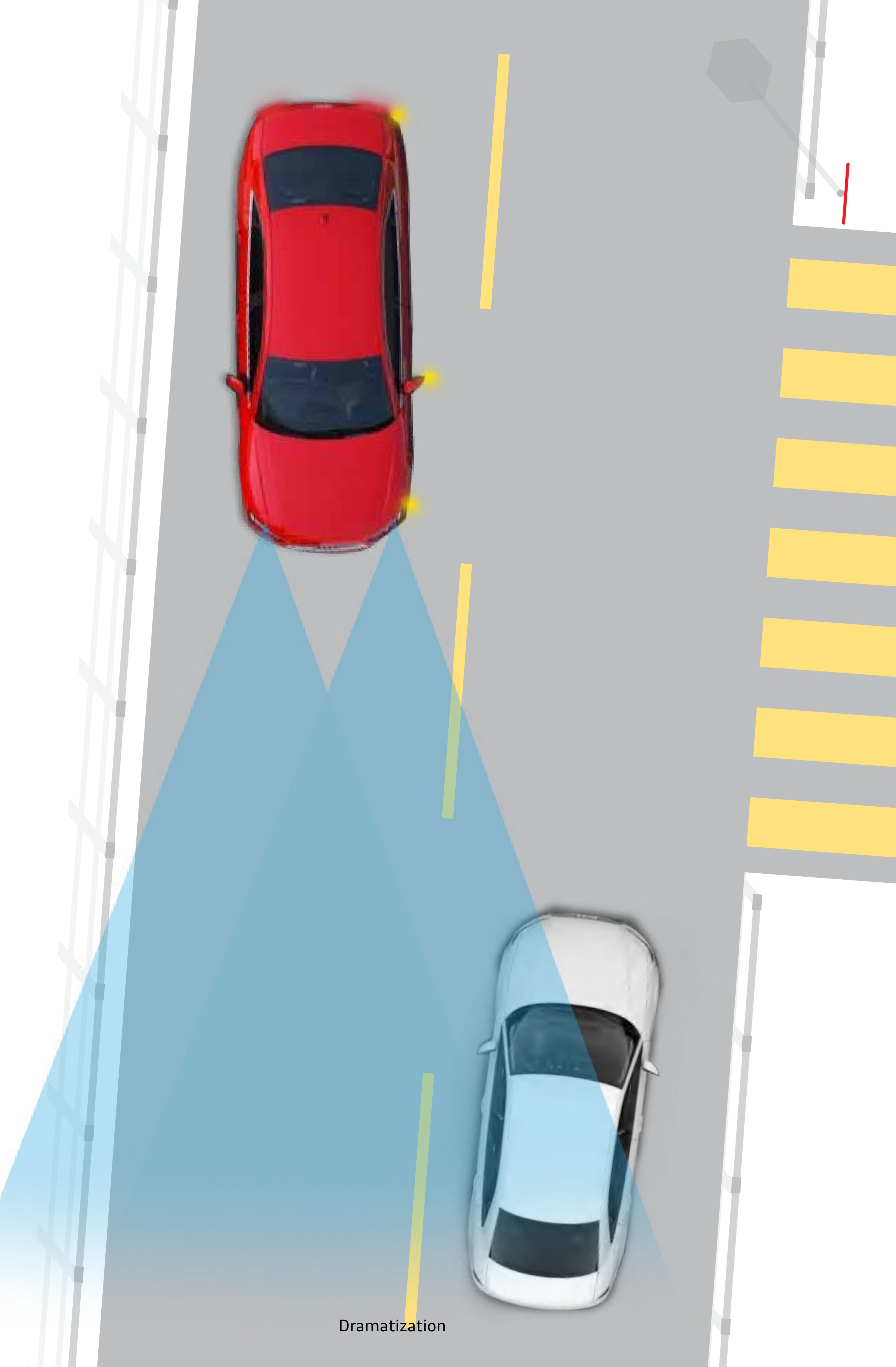

Dramatization

Rear cross traffic alert

Audi pre sense® city

Turn assist

This technology was designed to help monitor oncoming traffic when you are making a left at low speeds. If the system senses danger, it'll slow your Audi A4 to a halt while keeping it in your turning lane. Activation is triggered at speeds under 7 miles per hour and when you signal for a left turn.

[Schedule a Test Drive ↗](#)

1 The features discussed are not substitutes for attentive driving. Please see your owner's manual for further details and important limitations.







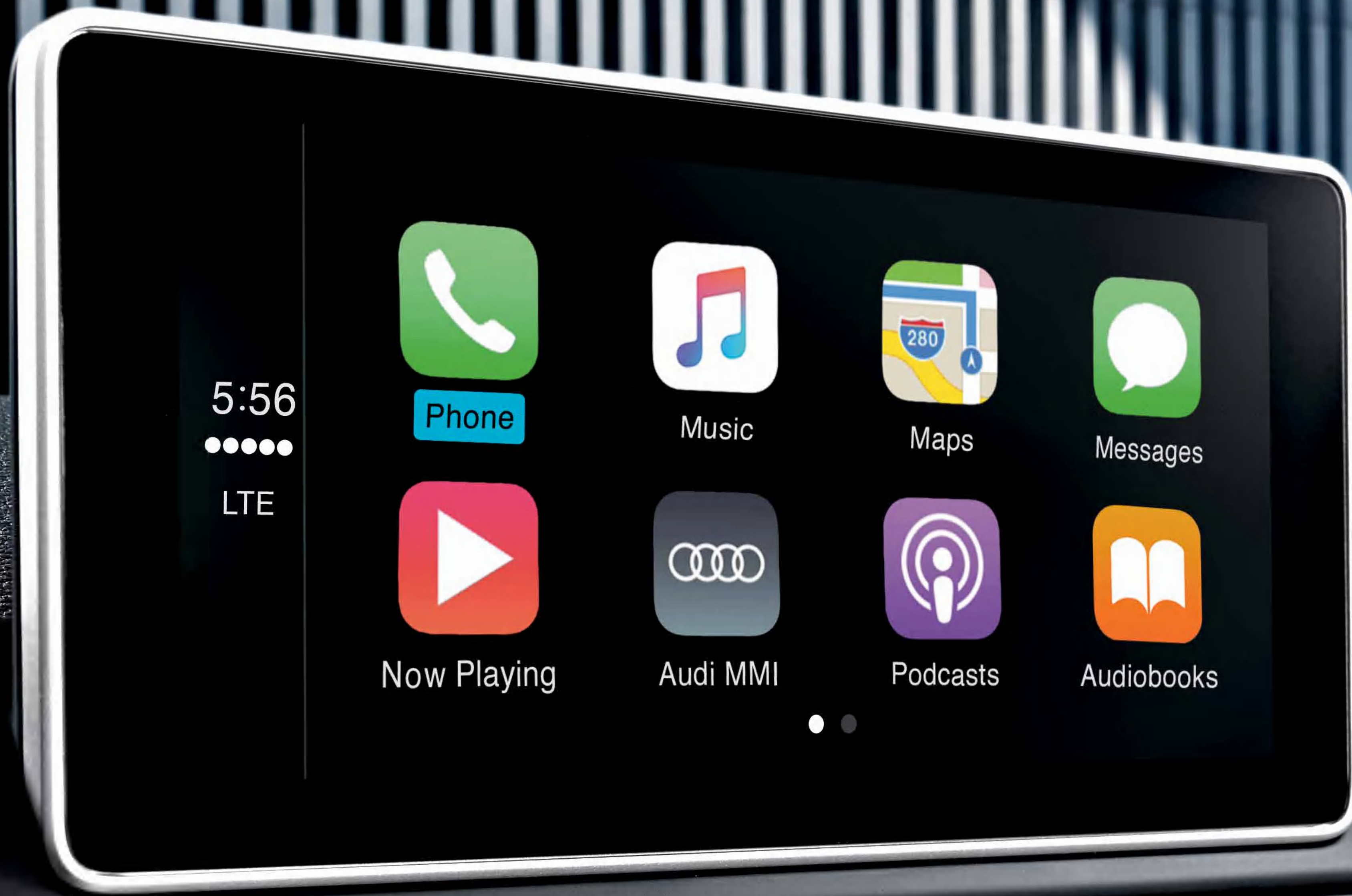

It's like driving your smartphone.

Take comfort in the familiarity of your mobile device. When linked with an iPhone® via standard Audi smartphone interface, Apple CarPlay™ gives you access to familiar and favorite apps such as Apple Music™, Maps and more. If you have a compatible Android device, Google™ Android Auto™ will connect you with apps like Google Play™, Google Maps™ and more.¹

¹ Always pay careful attention to the road, and do not drive while distracted. Not all features available on all operating systems. Standard text and data usage rates apply. These features require compatible device, operating system, and mobile apps. See mobile device and app providers for terms and privacy. "Android Auto" is a trademark of Google Inc. "Apple CarPlay" is a trademark of Apple Inc.

Your central command for the information age.

Sure, the handheld power of mobile devices is impressive, but then, they don't handle like your Audi. Luckily, Audi connect® offers your favorite familiar functionalities, with the means to help you get to where you want to go.¹ The next generation of Audi connect offers three available options—Connect CARE,² Connect PRIME³ and Connect PLUS.⁴ Connect CARE provides assistance and security services to help you in emergency situations, at no additional cost for 10 years after the purchase of your new vehicle. Connect PRIME offers a collection of robust features like Google Voice Search™ and Audi Semi-Dynamic Route Guidance with INRIX XD® Traffic to help you navigate and stay informed.⁵ And for live updates and entertainment, Connect PLUS keeps your passengers connected even on the go through an in-vehicle Wi-Fi® Hotspot with a 4G LTE connection.^{6,7} Both Connect PRIME and Connect PLUS features are offered complimentary for a six-month trial period, and after that, stay connected by visiting myAudiConnect.com.

STANDARD CONNECT CARE

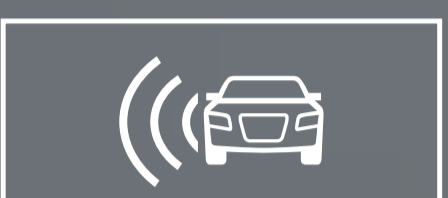

In case of an emergency situation, Audi connect® is equipped to help with online roadside assistance and automatic crash notifications. You can also initiate a request for emergency services by pushing the SOS button above the center console. And, in case of the unthinkable, Stolen Vehicle Locator services help authorities locate your vehicle.^{1,2,3}

With Audi Service Request, receive email and in-car notifications before you are due for service, helping you to easily schedule a service appointment with your Audi dealer.⁴

AVAILABLE CONNECT PRIME



With INRIX XD® Traffic, get fast and accurate traffic information (included in your active Audi connect® subscription) overlaid onto 3D satellite imagery to help visualize a true aerial view of your city and highway route, and let the MMI® navigation plus system reconfigure your route to help avoid traffic.⁵



With Google Earth™ integration, you'll enjoy 3D satellite imagery, including Google Street View™, displayed right on the MMI® display.



With Google Street View™, your Audi can show you a driver's-eye view of your destination right before you arrive so it's easy to recognize.⁶



Discover travel information for local landmarks in your area of interest, set them as destinations and let your vehicle show you the way.



Keeping your navigation map up to date is easier than ever with over-the-air map updates, sent directly to your vehicle.



It's simple. Tell your Audi what you are in the mood for, then let the cloud-processing power of Google™ speech recognition interpret your request and bring up a list of destinations in the area of your choice.



Use your Audi MMI® connect® App, or log in to your myAudi account online to access vehicle status reports, or use the Parking Position feature to help remember where you parked.^{9,10}



With BLUETOOTH® streaming audio, it's easier than ever to stream music from your compatible phone or digital music player right to the vehicle's audio system.



With access to text messages, emails and Twitter®, your passengers will know what's going on with their friends, family and the world.⁷



The point-of-interest search with an upgraded voice-control system means that you can get the most out of every journey.



Search for parking in your area of interest, check space availability and set your selection as a destination to help navigate directly to the garage entrance.⁸



With remote lock/unlock, you can easily lock or unlock your vehicle remotely through your compatible smartphone and SmartWatch.⁷



Get information about current events, exciting locations and places of interest at your travel destination, current location or other chosen location instantly.



A simple source for daily information on-demand, such as news updates from your favorite sources with text-to-speech function, fuel prices in your area and weather forecasts.

AVAILABLE CONNECT PLUS



Staying connected in your Audi has never been easier, with in-vehicle 4G LTE connectivity. Access is provided for up to eight passenger devices through an onboard wireless hotspot.^{11,12}

Always pay careful attention to the road, and do not drive while distracted. The features and technologies discussed above are optional, may require an additional subscription with separate terms and conditions, and should be used only when it is safe and appropriate. The Wi-Fi® hotspot feature is intended for passenger use only.

1 Roadside Assistance provided by an authorized third party service provider. 2 Automatic Crash Notification is enabled prior to purchase or lease and does not require registration or a subscription. 3 For use by law enforcement authorities only. See Terms of Service for details. 4 Always consult owner's manual for maintenance guidelines. 5 INRIX XD® Traffic is included with an Audi connect® subscription. 6 Always pay careful attention to the road, and do not drive while distracted. 7 Standard text and data usage rates apply. 8 Parking feature is not available in all areas and requires participation by parking provider. 9 Refer to your vehicle's warning and indicator lights for the most current diagnostic information. Always consult owner's manual for maintenance guidelines. 10 Requires Audi MMI® connect® App. Smartphone message and data rates apply. Do not use feature to locate stolen vehicle. 11 Always pay careful attention to the road, and do not drive while distracted. The Wi-Fi® hotspot feature is intended for passenger use only. Connect PLUS features and technologies are optional, may require an additional subscription with separate terms and conditions, and should be used only when it is safe and appropriate. See materials provided by wireless carrier for terms, privacy, data security details. Returning devices connect automatically and use plan data unless hotspot is removed from device settings. 12 4G LTE coverage is not available in all areas.





15:42

375 mi | Silk Road

1.8 mi

Potomac

Silver Spring

Colleg

Hyat

McLean

Walter Reed Army Medical Center

Washington

Western Ave

1 1/2 mi

72.2 mi
6:54 AM

04

P

1/min x 1000

MPH

5:11 AM 69°F

VIEW

OK

NAV

+

HI
LO
TO
°F

It's all about perspective.



It's all about perspective.



// Audi virtual cockpit

The available Audi virtual cockpit is another testament to the progressiveness of the new Audi A4. The cockpit is an innovative, fully digital instrument cluster shown on a class-leading 12.3-inch display, delivering vibrant, life-like images at 60 frames per second. There are two unique modes for viewing vital data: Classic and Infotainment. Classic mode offers a crisp, clear view of a traditional speedometer and tachometer; Infotainment mode minimizes the classic gauges, while maximizing navigation or other infotainment visuals.

[Search A4 Inventory](#) ↗



TOUCH





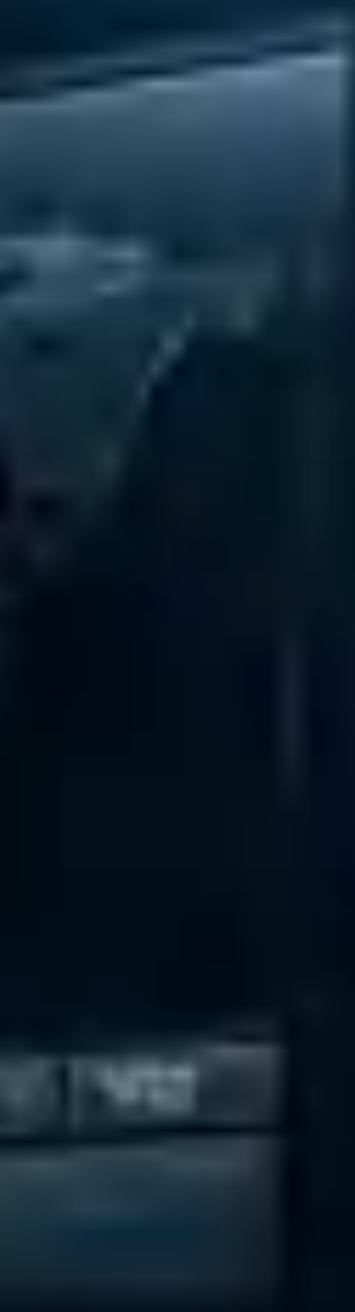

DATA LOG

TRACED DATA LOG



DATA LOG

RESEARCH DATA LOG



HEART PUC WAVEFORM



HEART PUB WAVEFORM



DATA LOG

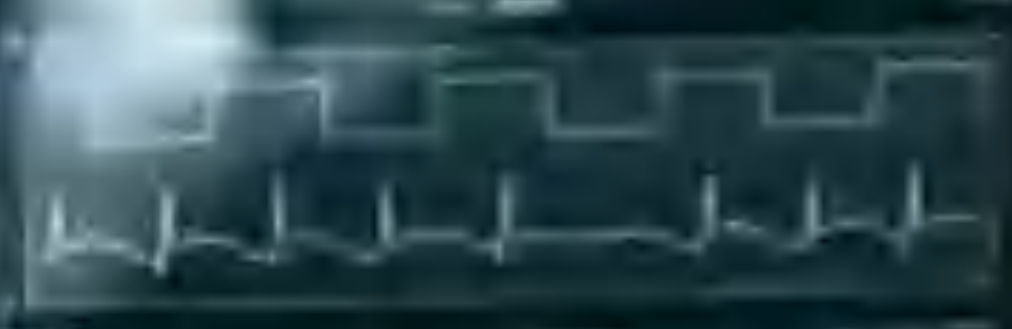

DATA LOG

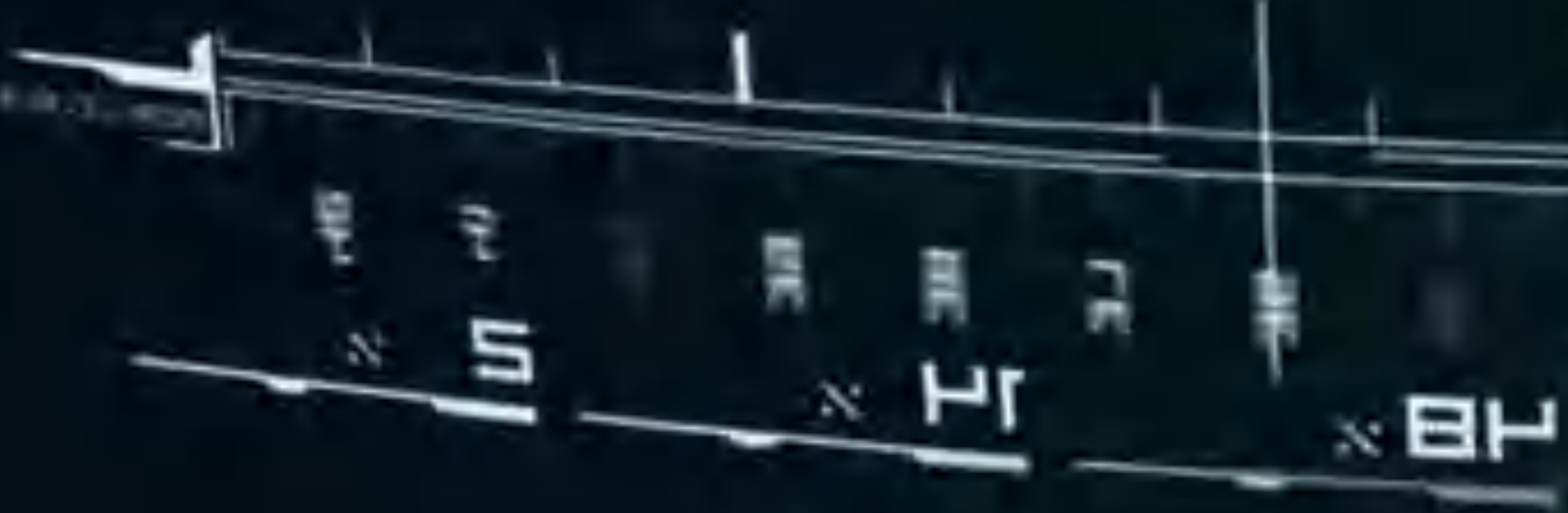

DATA LOG

DATA LOG







We feel you.

Connecting man with machine is complex work made simple from the Audi Human Machine Interface team. With features like the new available MMI® touch, which can read your natural handwriting, you may discover your machine really does get you.



We feel you.

Connecting man with machine is complex work made simple from the Audi Human Machine Interface team. With features like the new available MMI® touch, which can read your natural handwriting, you may discover your machine really does get you.





// MMI® navigation plus with voice control system

Count on the available advanced navigation system with voice commands to help hone in on your destination with stunning precision while putting a little more depth in your journey with help from Google Earth™.¹

// BLUETOOTH® wireless technology

Unlock your compatible mobile phone's potential through the MMI system. Simply pair them up and start enjoying near-complete control of your phone's functions or streaming audio at the touch of a button.



¹ MMI® navigation plus depends on signals from the worldwide Global Positioning Satellite network. The vehicle's electrical system and existing wireless and satellite technologies must be available and operating properly for the system to function. The system is designed to provide you with suggested routes in locating addresses, destinations and other points of interest. Changes in street names, construction zones, traffic flow, points of interest and other road system changes are beyond the control of Audi of America, Inc. Complete detailed mapping of lanes, roads, streets, toll roads, highways, etc., is not possible, therefore you may encounter discrepancies between the mapping and your actual location. Please rely on your individual judgment in determining whether or not to follow a suggested MMI® navigation plus route. Mapping updates are available at no charge for the first five map updates and are subsequently available on a subscription basis.



The opposite of the sounds of silence.

From perfectly sculpted high notes to rich deep lows, sound reaches another dimension with the available Bang & Olufsen® 3D Sound System.





// Bang & Olufsen® 3D Sound System

The passion of Bang & Olufsen® matches well with Audi. Just consider the exclusive collaboration to create the available Bang & Olufsen® 3D Sound System in the all-new Audi A4. You will experience both thrilling highs and sumptuous lows in their most lifelike form, provided by 19 speakers and powered by a 16-channel amplifier with an output of 755 watts. The high-quality design of the speakers both enhances the spaciousness of the sound and adds to the sleek interior look of the vehicle, giving sound an entirely new dimension.

[Schedule a Test Drive ↗](#)





Visualize 3D sound

Speakers

// 3D tweeter

// Surround speaker

// Subwoofer

// Center-fill speaker

// Center speaker

// 16-channel audio

// Tweeter

// 3D mid-range speaker

// Bass speaker

// Mid-range speaker

// Bass speaker

Visualize 3D sound

Speakers



Swipe to start Safety >

How we wrap our heads around safety.

Design

Engineering

Performance

Technology

Safety

Visualizer
Equipment
Accessories

Innovative pieces for peace of mind.

It is nearly impossible to control everything that happens on the road. That's why we are committed to providing some of the most advanced technologies and precise engineering.



2017 Audi A4 2.0T quattro® Premium Plus shown in Manhattan Gray metallic with available equipment.

All hands on deck.

At Audi, our engineers were tasked with coming up with innovative solutions to both weight savings and strength. Advanced occupant safety-cell airbag technology is designed based on seat position, and specially constructed crumple zones give way upon impact to help mitigate potential injury in a collision. Add the rigid laser seam-welded joints and it becomes clear we are helping to look out for you.

Energy absorption

The Audi A4 is designed to absorb force and distribute it throughout the vehicle as evenly as possible to help mitigate the impact of a collision.

// Airbags

Our comprehensive airbag system houses eight standard airbags, including front-impact and thorax side airbags for both the driver and the front passenger and available rear passenger thorax side bags.¹

// ESC

Electronic Stability Control helps minimize loss of stability, applying brake pressure to individual wheels and reducing throttle input to help counter oversteer or understeer when the vehicle needs it.

// ABS

While braking, the Anti-lock Braking System helps the wheels maintain contact with the surface of the road, preventing skidding and the wheels locking up.

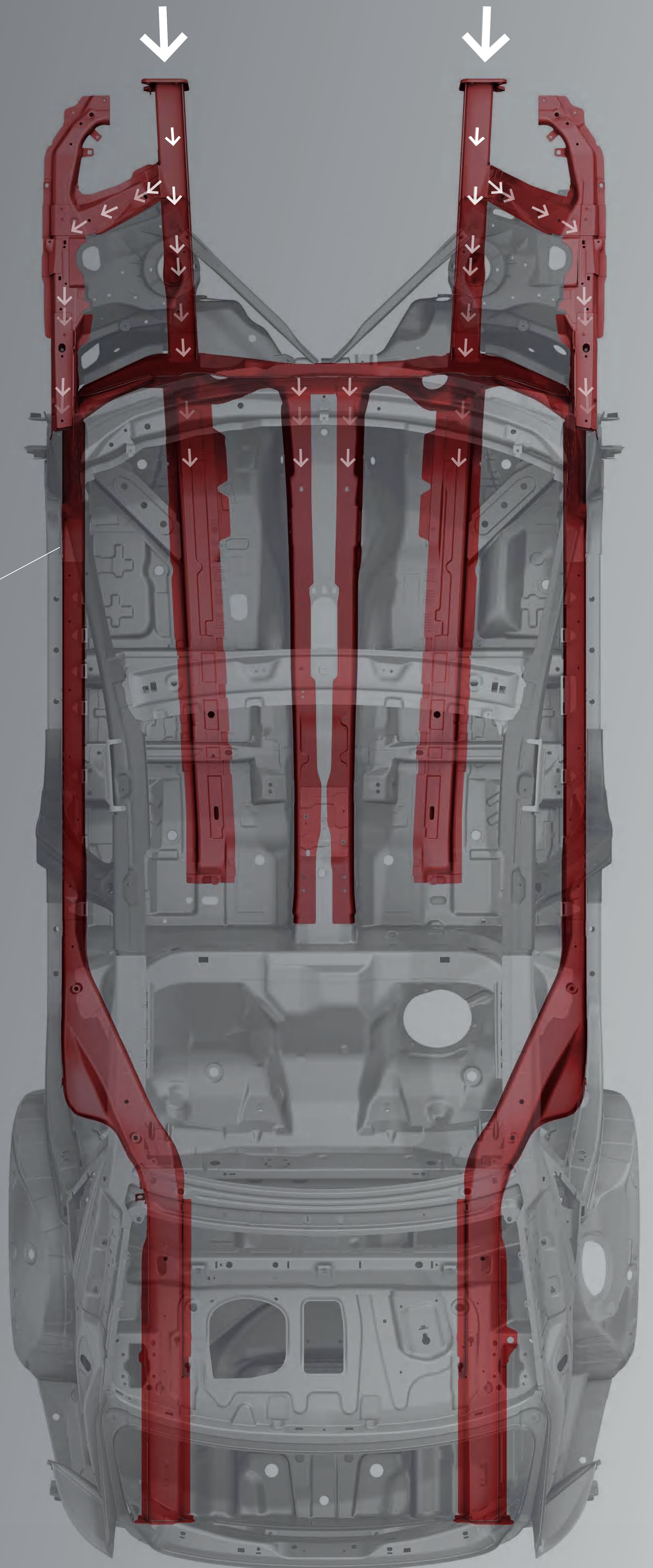

¹ Airbags are supplemental restraints only and will not deploy in all crash circumstances. Always use safety belts and seat children only in the rear, using restraint systems appropriate for their size and age.

Audi A4 Colors



Brilliant Black

[Search A4 Inventory ↗](#)

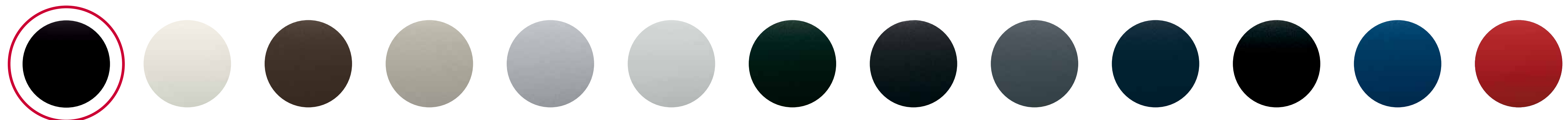

Exterior colors, interior colors, wheels and decorative inlay options will vary based on model and trim level combination. See your dealer for details.

Audi A4 Colors



Ibis White

[Search A4 Inventory ↗](#)

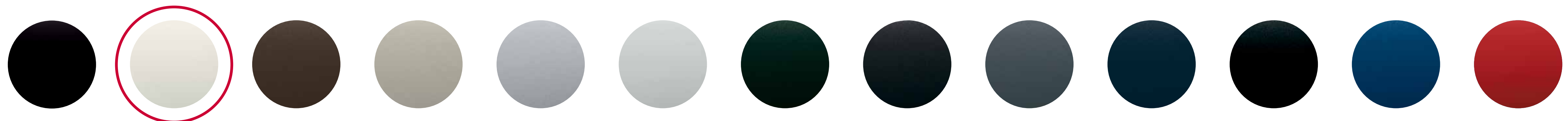

Exterior colors, interior colors, wheels and decorative inlay options will vary based on model and trim level combination. See your dealer for details.

Audi A4 Colors



Argus Brown metallic

[Search A4 Inventory ↗](#)

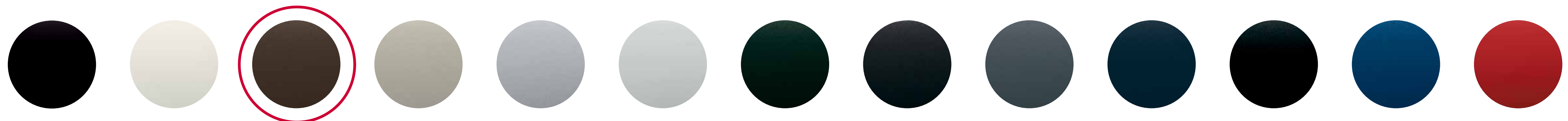

Exterior colors, interior colors, wheels and decorative inlay options will vary based on model and trim level combination. See your dealer for details.

Audi A4 Colors



Cuvée Silver metallic

[Search A4 Inventory ↗](#)

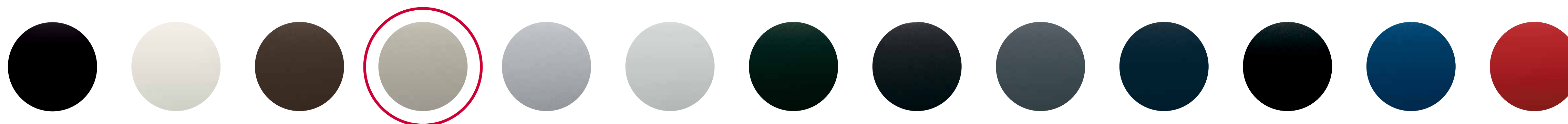

Exterior colors, interior colors, wheels and decorative inlay options will vary based on model and trim level combination. See your dealer for details.

Audi A4 Colors



Florett Silver metallic

[Search A4 Inventory ↗](#)

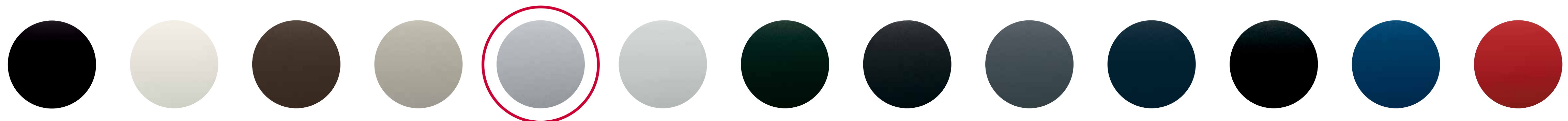

Exterior colors, interior colors, wheels and decorative inlay options will vary based on model and trim level combination. See your dealer for details.

Audi A4 Colors



Glacier White metallic

[Search A4 Inventory ↗](#)

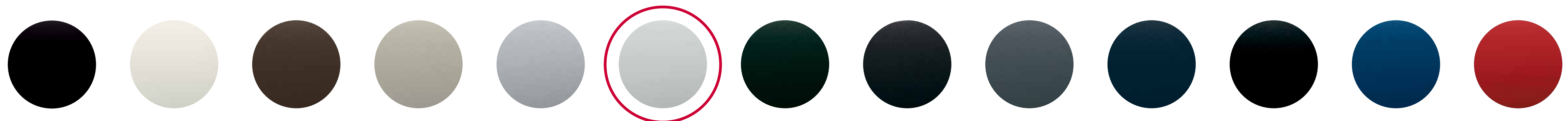

Exterior colors, interior colors, wheels and decorative inlay options will vary based on model and trim level combination. See your dealer for details.

Audi A4 Colors



Gotland Green metallic

[Search A4 Inventory ↗](#)

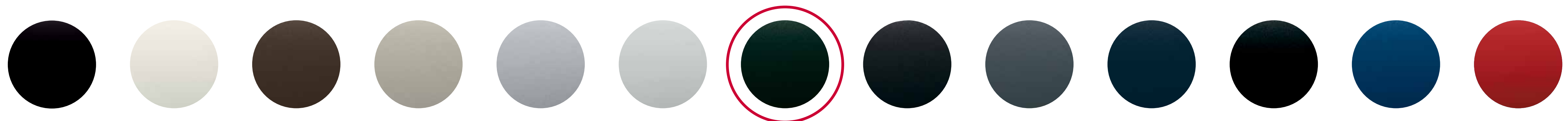

Exterior colors, interior colors, wheels and decorative inlay options will vary based on model and trim level combination. See your dealer for details.

Audi A4 Colors



Manhattan Gray metallic

[Search A4 Inventory ↗](#)

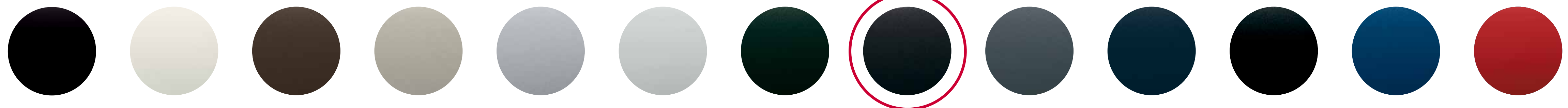

Exterior colors, interior colors, wheels and decorative inlay options will vary based on model and trim level combination. See your dealer for details.

Audi A4 Colors



Monsoon Gray metallic

[Search A4 Inventory ↗](#)

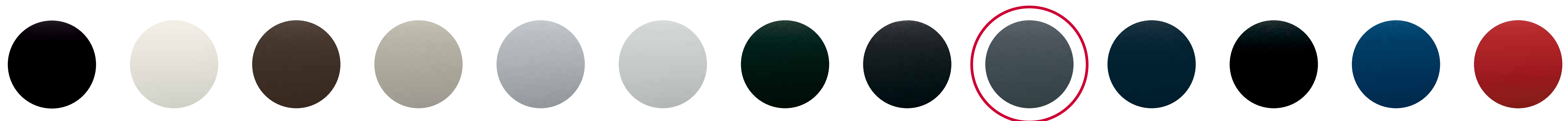

Exterior colors, interior colors, wheels and decorative inlay options will vary based on model and trim level combination. See your dealer for details.

Audi A4 Colors



Moonlight Blue metallic

[Search A4 Inventory ↗](#)

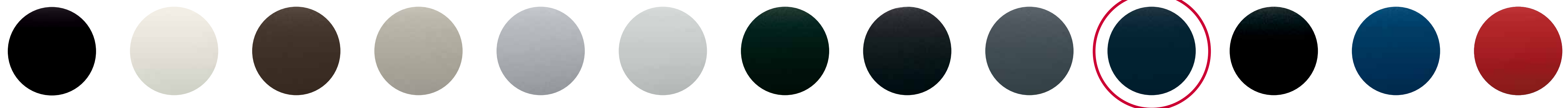

Exterior colors, interior colors, wheels and decorative inlay options will vary based on model and trim level combination. See your dealer for details.

Audi A4 Colors



Mythos Black metallic

[Search A4 Inventory ↗](#)

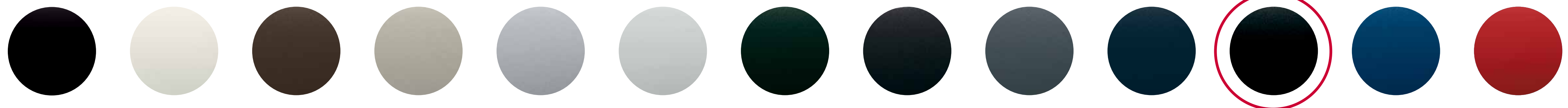

Exterior colors, interior colors, wheels and decorative inlay options will vary based on model and trim level combination. See your dealer for details.

Audi A4 Colors



Scuba Blue metallic

[Search A4 Inventory ↗](#)



Exterior colors, interior colors, wheels and decorative inlay options will vary based on model and trim level combination. See your dealer for details.

Audi A4 Colors



Tango Red metallic

[Search A4 Inventory ↗](#)

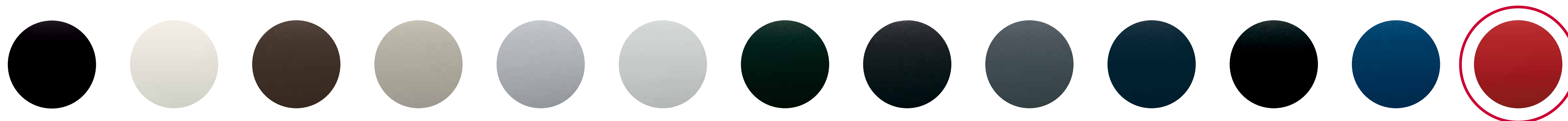

Exterior colors, interior colors, wheels and decorative inlay options will vary based on model and trim level combination. See your dealer for details.

Audi A4 Wheels



17" 5-parallel-spoke design

Standard on Premium

[Find A Local Dealer ↗](#)

[Build your 2017 A4 ↗](#)

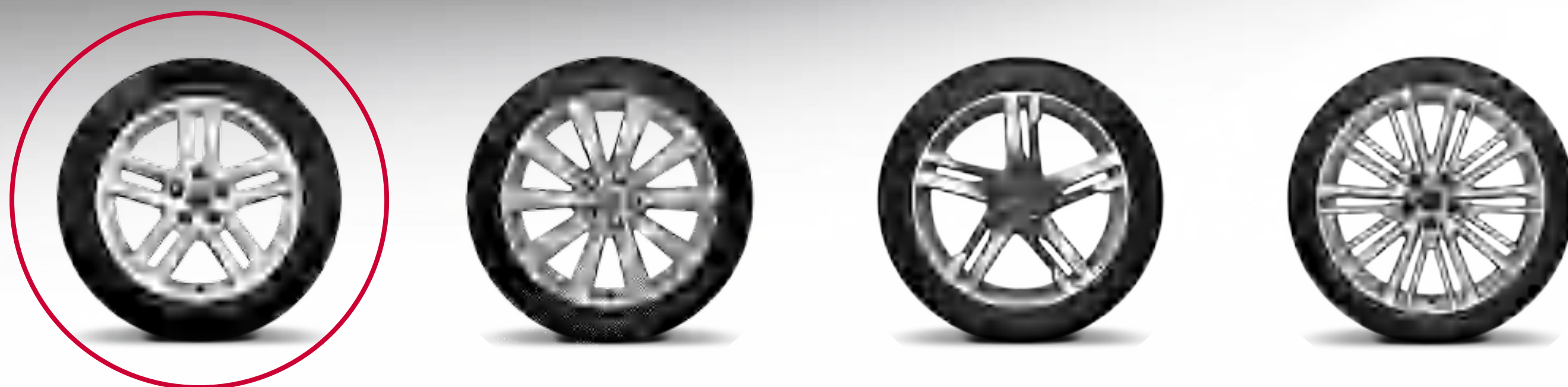

Exterior colors, interior colors, wheels and decorative inlay options will vary based on model and trim level combination. See your dealer for details.

Audi A4 Wheels



18" 10-spoke-star design

Optional on Premium

[Find A Local Dealer ↗](#)

[Build your 2017 A4 ↗](#)



Exterior colors, interior colors, wheels and decorative inlay options will vary based on model and trim level combination. See your dealer for details.

Audi A4 Wheels



18" 5-spoke dynamic design with contrasting
Gray/partially polished finish

Standard on Premium Plus and Prestige

[Find A Local Dealer ↗](#)

[Build your 2017 A4 ↗](#)



Exterior colors, interior colors, wheels and decorative inlay options will vary based on model and trim level combination. See your dealer for details.

Audi A4 Wheels



19" Audi Sport® 10-V-spoke design,
summer tires¹

Optional on Premium Plus and Prestige

[Find A Local Dealer ↗](#)

[Build your 2017 A4 ↗](#)



Tap here for available features and important safety information. >>



19" Audi Sport® 10-V-spoke design, summer tires¹

Optional on Premium Plus and Prestige

[Find A Local Dealer ↗](#)

[Build your 2017 A4 ↗](#)

Exterior colors, interior colors, wheels and decorative inlay options will vary based on model and trim level combination. See your dealer for details. Tires are supplied and warranted by their manufacturer. High-performance tires are designed for better performance and handling in warm climates. When driving in cold, snowy or icy weather, you should equip your vehicle with four all-season or winter tires, which offer better traction under those conditions. We suggest you use the Audi-recommended winter or all-season tires specified for your Audi. High-performance tires also have a lower aspect ratio that aids performance and handling. Driving over rough or damaged road surfaces, as well as debris, curbs and other obstacles, can cause serious damage to wheels, tires, vehicle body and suspension parts. Be careful to avoid road hazards and reduce your speed, especially if your vehicle is equipped with low-profile tires. Please also remember when making your selection that, while these tires deliver responsive handling, they may ride less comfortably and make more noise than others. Finally, these tires may wear more quickly than other choices. It is important that the inflation pressure is regularly checked and maintained at recommended levels.



Audi A4 Seats and Leather



Black leather

Standard | Premium, Premium Plus and Prestige

[Request a Quote ↗](#)

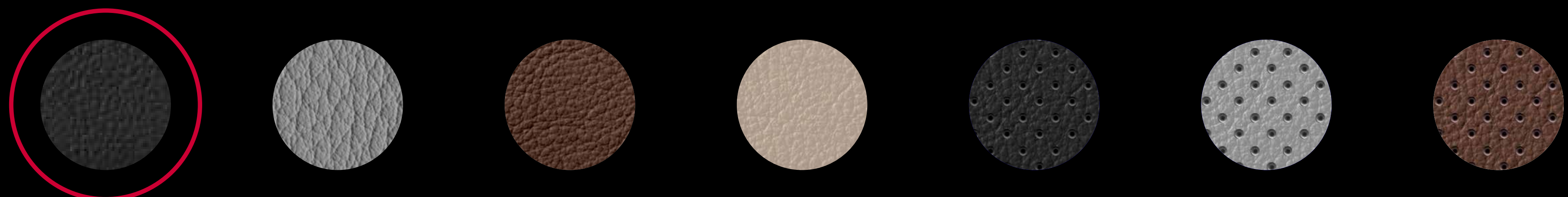

Decorative inlay options will vary based on model and interior color combination. See your dealer for details.

Audi A4 Seats and Leather



Rock gray

Standard | Premium, Premium Plus and Prestige

[Request a Quote ↗](#)

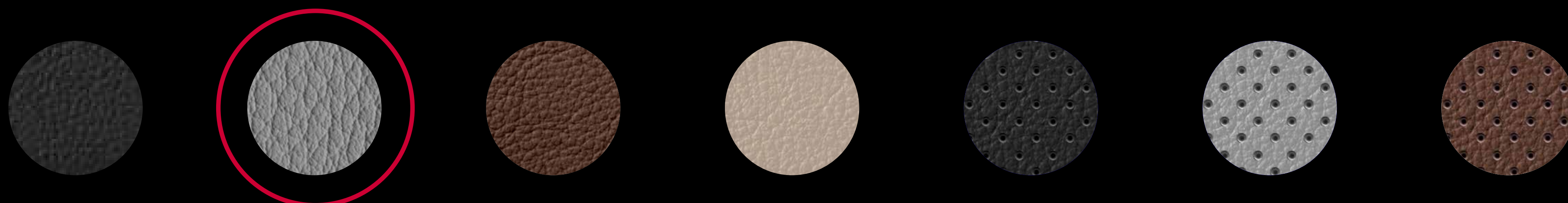

Decorative inlay options will vary based on model and interior color combination. See your dealer for details.

Audi A4 Seats and Leather



Nougat brown

Standard | Premium, Premium Plus and Prestige

[Request a Quote ↗](#)

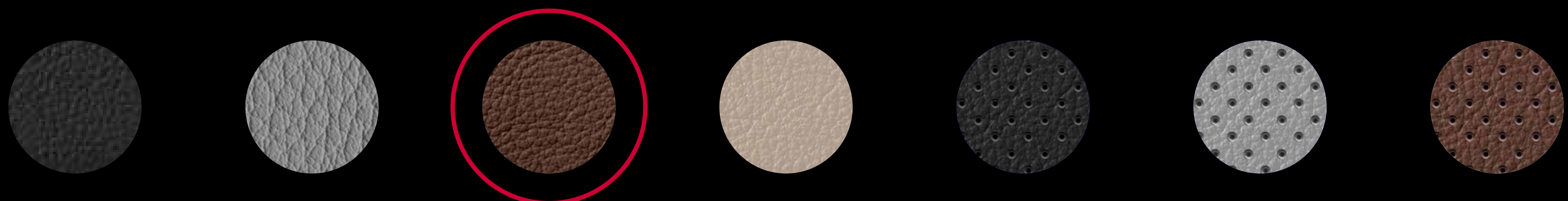

Decorative inlay options will vary based on model and interior color combination. See your dealer for details.

Audi A4 Seats and Leather



Atlas beige

Standard | Premium, Premium Plus and Prestige

[Request a Quote ↗](#)

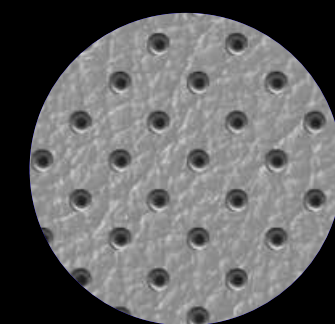
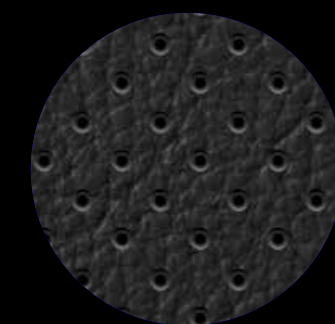
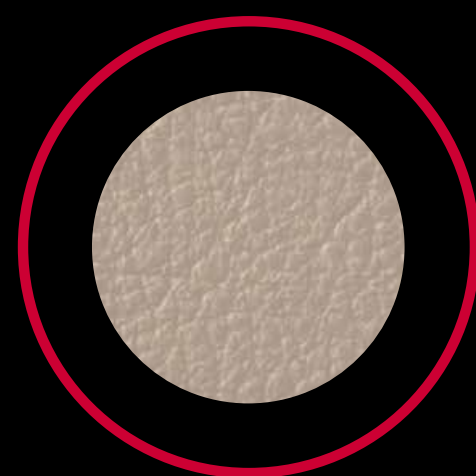
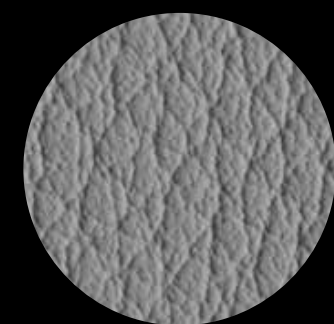
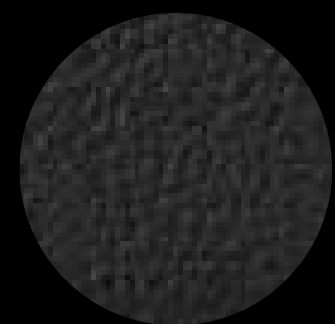

Decorative inlay options will vary based on model and interior color combination. See your dealer for details.

Audi A4 Seats and Leather



Black perforation¹

Standard | Premium, Premium Plus and Prestige

[Request a Quote ↗](#)

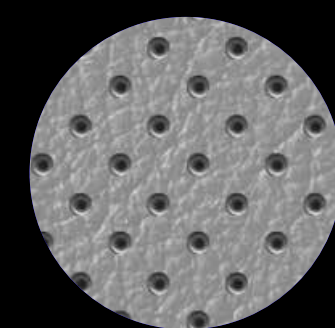
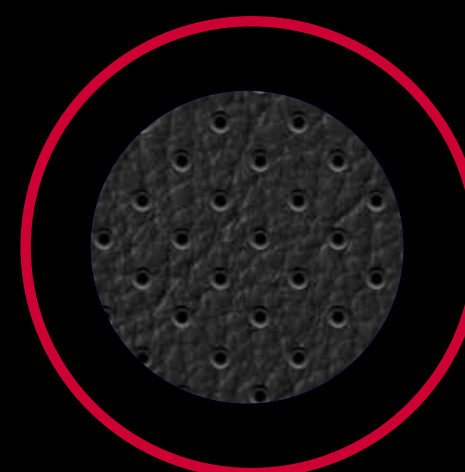
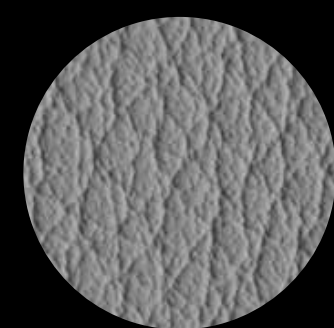
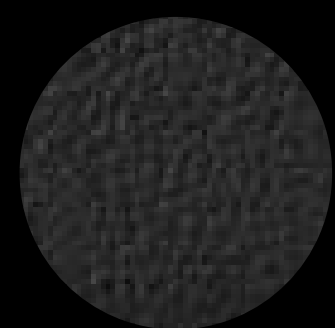

Decorative inlay options will vary based on model and interior color combination. See your dealer for details. 1 Requires Warm Weather package.

Audi A4 Seats and Leather



Rock gray perforation¹

Standard | Premium, Premium Plus and Prestige

[Request a Quote ↗](#)

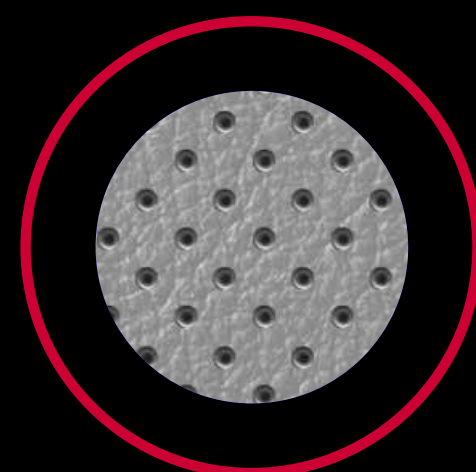
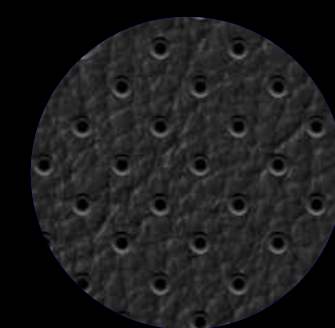
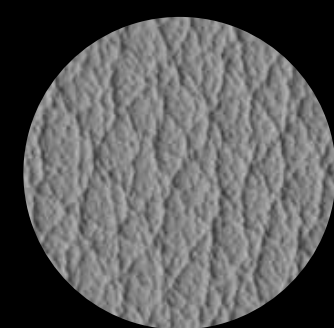
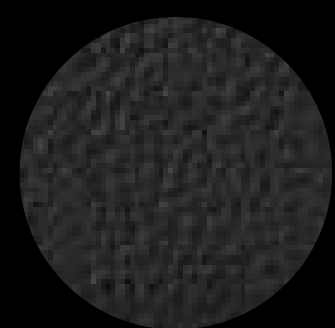

Decorative inlay options will vary based on model and interior color combination. See your dealer for details. 1 Requires Warm Weather package.

Audi A4 Seats and Leather



Nougat brown perforation¹

Standard | Premium, Premium Plus and Prestige

[Request a Quote ↗](#)

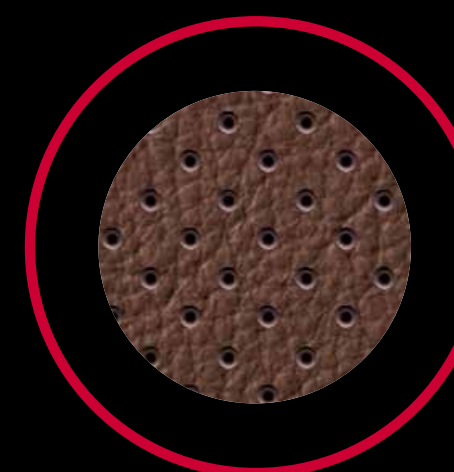
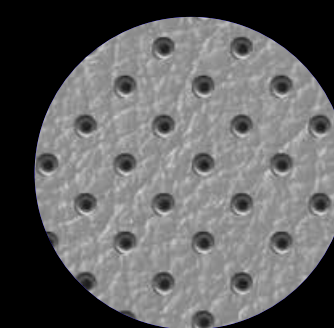
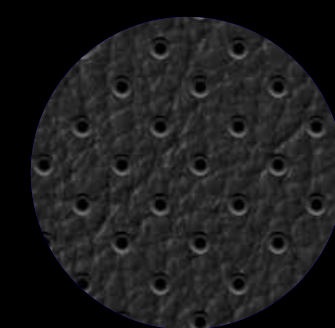
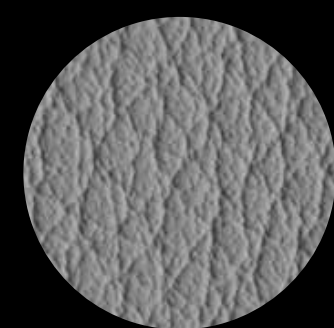
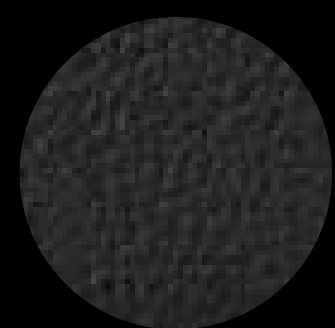

Decorative inlay options will vary based on model and interior color combination. See your dealer for details. 1 Requires Warm Weather package.

Audi A4 Inlays



Aluminum Ellipse

Available | Premium, Premium Plus and Prestige

[Search A4 Inventory ↗](#)



Decorative inlay options will vary based on model and interior color combination. See your dealer for details.

Audi A4 Inlays



High-gloss Dark Brown Walnut Wood

Available | Premium, Premium Plus and Prestige

[Search A4 Inventory ↗](#)

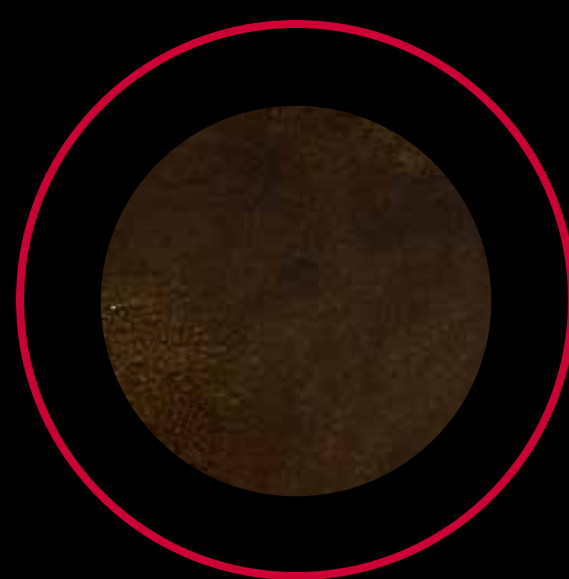

Decorative inlay options will vary based on model and interior color combination. See your dealer for details.

Audi A4 Inlays



Natural Gray Oak Wood

Available | Premium, Premium Plus and Prestige

[Search A4 Inventory ↗](#)



Decorative inlay options will vary based on model and interior color combination. See your dealer for details.

Audi A4 Specifications

A4
Premium



A4
Premium Plus



A4
Prestige



Available Models



Safety / Security



Driver Assistance / Innovation



Exterior



Interior / Seating



Infotainment / Technology



Packages



Stand-alone Options



Build your 2017 A4 

Audi A4 Specifications

A4
Premium



A4
Premium Plus



A4
Prestige



Available Models

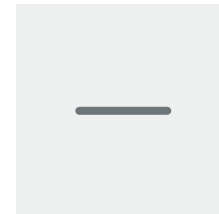

2.0-liter TFSI®

Direct-injection turbocharged
four-cylinder engine
252 hp / 273 lb-ft

2.0-liter TFSI®

Direct-injection turbocharged
four-cylinder engine
252 hp / 273 lb-ft

2.0-liter TFSI®

Direct-injection turbocharged
four-cylinder engine
252 hp / 273 lb-ft

Safety / Security



Driver Assistance / Innovation



Exterior



Interior / Seating



Infotainment / Technology



Packages



Stand-alone Options



Build your 2017 A4 [↗](#)

Audi A4 Specifications

A4 Premium



A4 Premium Plus



A4 Prestige



Safety / Security

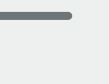

+ In addition to A4 Premium
○ Replaces A4 Premium

+ In addition to A4 Premium Plus
○ Replaces A4 Premium Plus

Driver adaptive and front passenger dual-stage airbags ¹	Driver adaptive and front passenger dual-stage airbags ¹	Driver adaptive and front passenger dual-stage airbags ¹
Driver and front-passenger thorax side airbags ¹	Driver and front-passenger thorax side airbags ¹	Driver and front-passenger thorax side airbags ¹
Driver and front-passenger knee airbags ¹	Driver and front-passenger knee airbags ¹	Driver and front-passenger knee airbags ¹
Sideguard® head-curtain airbags ¹	Sideguard® head-curtain airbags ¹	Sideguard® head-curtain airbags ¹
Safety belt reminder for driver and front passenger	Safety belt reminder for driver and front passenger	Safety belt reminder for driver and front passenger
Lower Anchors and Tethers for Children (LATCH) in rear seats	Lower Anchors and Tethers for Children (LATCH) in rear seats	Lower Anchors and Tethers for Children (LATCH) in rear seats
Power central locking system with safety unlock feature if airbags deploy	Power central locking system with safety unlock feature if airbags deploy	Power central locking system with safety unlock feature if airbags deploy
Integrated child door locks in rear doors	Integrated child door locks in rear doors	Integrated child door locks in rear doors
Electronic Stability Control (ESC) with secondary collision brake assist and traction control (ASR)	Electronic Stability Control (ESC) with secondary collision brake assist and traction control (ASR)	Electronic Stability Control (ESC) with secondary collision brake assist and traction control (ASR)
Anti-lock Brake System (ABS) with Electronic Brake-pressure Distribution (EBD) and brake assist	Anti-lock Brake System (ABS) with Electronic Brake-pressure Distribution (EBD) and brake assist	Anti-lock Brake System (ABS) with Electronic Brake-pressure Distribution (EBD) and brake assist
Tire-pressure monitoring system	Tire-pressure monitoring system	Tire-pressure monitoring system
Electromechanical parking brake	Electromechanical parking brake	Electromechanical parking brake
Vehicle immobilizer	○ Anti-theft alarm system with immobilizer	Anti-theft alarm system with immobilizer

¹ Airbags are supplemental restraints only and will not deploy in all crash circumstances. Always use safety belts and seat children only in the rear, using restraint systems appropriate for their size and age.

Available Models



Driver Assistance / Innovation



Exterior



Interior / Seating



Infotainment / Technology



Packages



Stand-alone Options



Build your 2017 A4 [↗](#)

Audi A4 Specifications

A4 Premium



A4 Premium Plus



A4 Prestige



Driver Assistance / Innovation

+ In addition to A4 Premium
 ○ Replaces A4 Premium

+ In addition to A4 Premium Plus
 ○ Replaces A4 Premium Plus

Keyless engine start/stop	○ Audi advanced key - keyless start, stop and entry with hands-free trunk lid release ¹	Audi advanced key - keyless start, stop and entry with hands-free trunk lid release ¹
Rain/light sensor for automatic windshield wipers and headlights	Rain/light sensor for automatic windshield wipers and headlights	Rain/light sensor for automatic windshield wipers and headlights
Cruise control with coast, resume and accelerate features	Cruise control with coast, resume and accelerate features	Cruise control with coast, resume and accelerate features
Audi pre sense® basic ²	Audi pre sense® basic ²	Audi pre sense® basic ²
		+ Audi side assist and Audi pre sense® rear ² - with Rear cross traffic alert ² - with Vehicle exit assist ²
Audi pre sense® city ²	Audi pre sense® city ²	Audi pre sense® city ²
		+ Head-up display with navigation and assistance systems information
Audi drive select	Audi drive select	Audi drive select
Rear view camera	○ Parking system plus with rear view camera (front and rear acoustic sensors) ³	Parking system plus with rear view camera (front and rear acoustic sensors) ³
		+ Parking system plus with top view camera system ³

1 Some Audi models are equipped with a keyless ignition feature. The details as to how the system works can vary, and Audi owners should consult their owner's literature or an authorized Audi dealer if they have further questions about the operation of this feature. Please note that Audi warns against leaving the vehicle unattended with the engine running, particularly in enclosed spaces. 2 Driver assistance features are not substitutes for attentive driving. See owner's manual for further details and important limitations. 3 Parking feature is not available in all areas and requires participation by parking provider.

Available Models



Safety / Security



Exterior



Interior / Seating



Infotainment / Technology



Packages



Stand-alone Options



Build your 2017 A4

Audi A4 Specifications

A4 Premium



A4 Premium Plus



A4 Prestige



Exterior

+ In addition to A4 Premium
○ Replaces A4 Premium

+ In addition to A4 Premium Plus
○ Replaces A4 Premium Plus

17" 5-parallel-spoke design wheels with 225/50 95H all-season tires

○ 18" 5-spoke dynamic design contrasting Gray/partially polished wheels with 245/40 R18 93H all-season tires¹

18" 5-spoke dynamic design contrasting Gray/partially polished wheels with 245/40 R18 93H all-season tires¹

Singleframe® grille

Singleframe® grille

Singleframe® grille

Xenon plus headlights with LED daytime running lights

○ Full LED headlights

Full LED headlights

Automatic headlights

Automatic headlights

Automatic headlights

LED taillights with dynamic turn signals

LED taillights with dynamic turn signals

LED taillights with dynamic turn signals

LED rear fog lights

LED rear fog lights

LED rear fog lights

Power-adjustable, heated exterior side mirrors

○ Power-adjustable, auto-dimming, power-folding, heated exterior side mirrors with memory

Power-adjustable, auto-dimming, power-folding, heated exterior side mirrors with memory

LED turn signals integrated into the exterior side mirror housings

LED turn signals integrated into the exterior side mirror housings

LED turn signals integrated into the exterior side mirror housings

+ S line® exterior appearance—front and rear bumpers, body-colored door sill blades, S line® fender badges, Twilight Gray matte rear diffuser

S line® exterior appearance—front and rear bumpers, body-colored door sill blades, S line® fender badges, Twilight Gray matte rear diffuser

Black trim around exterior side windows

○ Aluminum trim around exterior side windows

Aluminum trim around exterior side windows

Heated windshield washer nozzles

Heated windshield washer nozzles

Heated windshield washer nozzles

Dual exhaust outlets with chrome tips

Dual exhaust outlets with chrome tips

Dual exhaust outlets with chrome tips

¹ When driving during cold, snowy or icy weather conditions, ensure that your vehicle is equipped with appropriate all-season or winter tires. Even with appropriate tires, you must always drive in a manner appropriate for the weather, visibility and road conditions.

Available Models



Safety / Security



Driver Assistance / Innovation



Interior / Seating



Infotainment / Technology



Packages



Stand-alone Options



Build your 2017 A4 [➤](#)

Audi A4 Specifications

A4 Premium



A4 Premium Plus



A4 Prestige



Interior / Seating

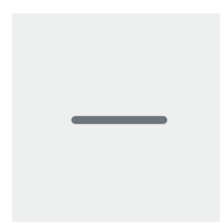

+ In addition to A4 Premium
 ○ Replaces A4 Premium

+ In addition to A4 Premium Plus
 ○ Replaces A4 Premium Plus

Three-zone automatic climate control	Three-zone automatic climate control	Three-zone automatic climate control
Three-spoke multifunction steering wheel with shift paddles	Three-spoke multifunction steering wheel with shift paddles	Three-spoke multifunction steering wheel with shift paddles
Tilt and telescopic manually adjustable steering column	Tilt and telescopic manually adjustable steering column	Tilt and telescopic manually adjustable steering column
Auto-dimming interior rear view mirror with digital compass	Auto-dimming interior rear view mirror with digital compass	Auto-dimming interior rear view mirror with digital compass
Aluminum Ellipse inlays	Aluminum Ellipse inlays	Aluminum Ellipse inlays
Leather-wrapped gear selector	Leather-wrapped gear selector	Leather-wrapped gear selector
Comfort front armrest	Comfort front armrest	Comfort front armrest
Four beverage holders	Four beverage holders	Four beverage holders
Leather seating surfaces	Leather seating surfaces	Leather seating surfaces
Eight-way power front seats and four-way power lumbar adjustment for driver	Eight-way power front seats and four-way power lumbar adjustment for driver	Eight-way power front seats and four-way power lumbar adjustment for driver
	+ Driver seat memory	Driver seat memory
Split-folding 40/20/40 rear seatbacks	Split-folding 40/20/40 rear seatbacks	Split-folding 40/20/40 rear seatbacks
Driver and front passenger comfort head restraints	Driver and front passenger comfort head restraints	Driver and front passenger comfort head restraints
	+ Heated front seats	Heated front seats
Driver and front passenger extendable sun visors with illuminated vanity mirrors	Driver and front passenger extendable sun visors with illuminated vanity mirrors	Driver and front passenger extendable sun visors with illuminated vanity mirrors
Power windows with one-touch up/down operation and power retention until front door is opened	Power windows with one-touch up/down operation and power retention until front door is opened	Power windows with one-touch up/down operation and power retention until front door is opened
Cloth headliner	Cloth headliner	Cloth headliner
Ambient LED interior lighting package	Ambient LED interior lighting package	○ Ambient LED interior lighting plus package
Sunroof	Sunroof	Sunroof
Front and rear floor mats	Front and rear floor mats	Front and rear floor mats
Black plastic door sill inlays	○ S line® stainless steel door sill inlays	S line® stainless steel door sill inlays
Trunk storage package (side nets, four cargo tie-downs and grocery hook)	Trunk storage package (side nets, four cargo tie-downs and grocery hook)	Trunk storage package (side nets, four cargo tie-downs and grocery hook)

Available Models



Safety / Security



Driver Assistance / Innovation



Exterior



Infotainment / Technology



Packages



Stand-alone Options



Build your 2017 A4

Audi A4 Specifications

A4 Premium



A4 Premium Plus



A4 Prestige



Infotainment / Technology

- + In addition to A4 Premium
- o Replaces A4 Premium

- + In addition to A4 Premium Plus
- o Replaces A4 Premium Plus

5.0" monochrome driver information system	5.0" monochrome driver information system	o Audi virtual cockpit (12.3" LCD fully digital instrument cluster and two visual modes: Classic and Infotainment)
Voice control system	Voice control system	Voice control system
		+ MMI® navigation plus with voice control system ¹
		+ MMI® touch with handwriting-recognition technology
	+ Audi connect® CARE assistance and security services ²	Audi connect® CARE assistance and security services ²
		+ Six-month trial subscription to Audi connect® PRIME and PLUS online services ²
		+ INRIX XD® Traffic ³
Audi smartphone integration including Apple® CarPlay and Google™ Android Auto ⁴	Audi smartphone integration including Apple® CarPlay and Google™ Android Auto ⁴	Audi smartphone integration including Apple® CarPlay and Google™ Android Auto ⁴
7.0" MMI® center infotainment display	7.0" MMI® center infotainment display	o 8.3" MMI® center infotainment/navigation display
Audi sound system with ten speakers and single CD player with MP3 playback capability	o Bang & Olufsen 3D Sound System with 19 speakers, 16-channel amplifier and 755 watts	Bang & Olufsen 3D Sound System with 19 speakers, 16-channel amplifier and 755 watts
HD Radio™ Technology	HD Radio™ Technology	HD Radio™ Technology
	+ SiriusXM® Satellite Radio with 90-day trial subscription ⁵	SiriusXM® Satellite Radio with 90-day trial subscription ⁵
SDXC card slots with 64GB operating capacity (dual slots)	SDXC card slots with 64GB operating capacity (dual slots)	SDXC card slots with 64GB operating capacity (dual slots)
Audi music interface with two USB ports for data and charging	Audi music interface with two USB ports for data and charging	Audi music interface with two USB ports for data and charging
BLUETOOTH® streaming audio for compatible devices	BLUETOOTH® streaming audio for compatible devices	BLUETOOTH® streaming audio for compatible devices
BLUETOOTH® wireless technology preparation for compatible mobile phones	BLUETOOTH® wireless technology preparation for compatible mobile phones	BLUETOOTH® wireless technology preparation for compatible mobile phones
Garage door opener (HomeLink®)	Garage door opener (HomeLink®)	Garage door opener (HomeLink®)

1. MMI® navigation plus depends on signals from the worldwide Global Positioning Satellite network. The vehicle's electrical system and existing wireless and satellite technologies must be available and operating properly for the system to function. The system is designed to provide you with suggested routes in locating addresses, destinations and other points of interest. Changes in street names, construction zones, traffic flow, points of interest and other road system changes are beyond the control of Audi of America, Inc. Complete detailed mapping of lanes, roads, streets, toll roads, highways, etc., is not possible, therefore you may encounter discrepancies between the mapping and your actual location. Please rely on your individual judgment in determining whether or not to follow a suggested MMI® navigation plus route. Mapping updates are available at no charge for the first five map updates and are subsequently available on a subscription basis. 2. Always pay careful attention to the road, and do not drive while distracted. Audi connect® should only be used when it is safe and appropriate. Audi connect® services and features are optional, provided with the support of authorized affiliated and third party service providers, and may require additional subscriptions with separate terms and conditions. Available on select models. Certain services collect location information, see Terms of Service for information about how to disable and for other details. 3. INRIX XD® Traffic is available on all Model Year 16+ A6, A7, TT and Q7 vehicles and is included with an Audi connect® subscription. Other models (allroad, A3, A4, A5, A8, Q3 and Q5) include SiriusXM® Traffic for four years with the purchase of the vehicle. 4. Always pay careful attention to the road, and do not drive while distracted. Not all features available on all operating systems. Standard text and data usage rates apply. These features require compatible device, operating system, and mobile apps. See mobile device and app providers for terms and privacy. "Android Auto" is a trademark of Google Inc. "Apple CarPlay" is a trademark of Apple Inc. 5. SiriusXM® Satellite Radio subscriptions sold separately or as a package after trial expires. Subscriptions are governed by SiriusXM® Customer Agreement (see www.siriusxm.com) and are continuous until you call SiriusXM® to cancel. Sirius U.S. Satellite Service available only to those 18 and older in the 48 contiguous U.S.A., D.C and Puerto Rico (with coverage limitations).

Available Models



Safety / Security



Driver Assistance / Innovation



Exterior



Interior / Seating



Packages



Stand-alone Options



Build your 2017 A4

Audi A4 Specifications

A4 Premium



A4 Premium Plus



A4 Prestige



Packages

Convenience package

- > Anti-theft alarm system with immobilizer
- > Audi advanced key – keyless start, stop and entry with hands-free trunk lid release²
- > Power-adjustable, auto-dimming, heated exterior side mirrors with memory
- > Driver seat memory
- > SiriusXM[®] Satellite Radio with 90-day trial subscription⁴

MMI[®] Navigation plus package

- > 7.0" color driver information system
- > MMI[®] navigation plus with voice control system³
- > MMI[®] touch with handwriting-recognition technology
- > 8.3" MMI[®] center infotainment/navigation display
- > Audi connect[®] CARE assistance and security services⁵
- > Six-month trial subscription to Audi connect[®] PRIME and PLUS online services^{5,6}
- > INRIX XD[®] Traffic⁷

Sport package

- > Sport suspension
- > Black cloth headliner
- > Front sport seats with four-way power lumbar adjustment

18" Wheel package

- > 18" 10-spoke-star design wheels
- > 245/40 R18 93H all-season tires⁹

Technology package

- > Audi side assist and Audi pre sense[®] rear¹
 - with Rear cross traffic alert¹
 - with Vehicle exit assist¹
- > Audi virtual cockpit (12.3" LCD fully digital instrument cluster and two visual modes: Classic and Infotainment)
- > MMI[®] navigation plus with voice control system³
- > MMI[®] touch with handwriting-recognition technology
- > Six-month trial subscription to Audi connect[®] PRIME and PLUS online services^{5,6}
- > INRIX XD[®] Traffic⁷
- > 8.3" MMI[®] center infotainment/navigation display

Sport package

- > Sport suspension
- > Black cloth headliner
- > Front sport seats with four-way power lumbar adjustment

Cold Weather package

- > Heated rear seats
- > Heated three-spoke multifunction steering wheel with shift paddles

19" Wheel package

- > 19" Audi Sport[®] 10-V-spoke design wheels
- > 245/35 R19 93Y XL summer performance tires⁸

Driver Assistance package

- > Audi adaptive cruise control with stop & go and traffic jam assist¹
- > Audi pre sense[®] front¹
 - with collision avoidance assist¹
 - with turn assist¹
- > Traffic sign recognition³
- > Audi active lane assist³
- > High-beam assistant

Warm Weather package

- > Ventilated front sport seats
- > Manual rear-side window sunshades

Cold Weather package

- > Heated rear seats
- > Heated three-spoke multifunction steering wheel with shift paddles

19" Wheel package

- > 19" Audi Sport[®] 10-V-spoke design wheels
- > 245/35 R19 93Y XL summer performance tires⁸

Sport package

- > Sport suspension
- > Black cloth headliner
- > Front sport seats with four-way power lumbar adjustment

1. Driver assistance features are not substitutes for attentive driving. See owner's manual for further details and important limitations. 2. Some Audi models are equipped with a keyless ignition feature. The details as to how the system works can vary, and Audi owners should consult their owner's literature or an authorized Audi dealer if they have further questions about the operation of this feature. Please note that Audi warns against leaving the vehicle unattended with the engine running, particularly in enclosed spaces. 3. MMI[®] navigation plus depends on signals from the worldwide Global Positioning Satellite network. The vehicle's electrical system and existing wireless and satellite technologies must be available and operating properly for the system to function. The system is designed to provide you with suggested routes in locating addresses, destinations and other points of interest. Changes in street names, construction zones, traffic flow, points of interest and other road system changes are beyond the control of Audi of America, Inc. Complete detailed mapping of lanes, roads, streets, toll roads, highways, etc., is not possible, therefore you may encounter discrepancies between the mapping and your actual location. Please rely on your individual judgment in determining whether or not to follow a suggested MMI[®] navigation plus route. Mapping updates are available at no charge for the first five map updates and are subsequently available on a subscription basis. 4. SiriusXM[®] Satellite Radio subscriptions sold separately or as a package after trial expires. Subscriptions are governed by SiriusXM[®] Customer Agreement (see www.siriusxm.com) and are continuous until you call SiriusXM[®] to cancel. Sirius U.S. Satellite Service available only to those 18 and older in the 48 contiguous U.S.A., D.C and Puerto Rico (with coverage limitations). 5. Always pay careful attention to the road, and do not drive while distracted. Connect PRIME services are optional, may require an additional subscription with separate terms and conditions, and should be used only when it is safe and appropriate. Trial or paid subscription required. Connect PRIME services require vehicle cellular connectivity and availability of vehicle GPS signal; certain services collect location information, see Terms of Service for information about how to disable. See Terms of Service, Privacy Policy, and other details at www.audiusa.com/audiconnect-privacy and www.audiusa.com/audiconnect-terms. Connect PRIME services should only be used when it is safe and appropriate. 6. Pre-paid session-based plans, available for domestic use only. Plans expire when full data allotment is used or time period ends, whichever comes first. Monthly plans auto-renew every 30 days and charges are billed to the credit card on file on the last day of the 30-day term, for the next 30-day time period, unless canceled. To cancel monthly plans at any time, visit myaudiconnect.com or call 1-877-505-2834. Other plans do not auto-renew. Wi-Fi[®]: Connectivity for up to 8 Wi-Fi[®] capable devices. General Wireless Service Terms: Subject to the Session Based Wireless Data Services Agreement. Other restrictions and terms apply and may result in service termination and/or limitations. Coverage and service not available everywhere. 7. INRIX XD[®] Traffic is available on all Model Year 16+ A6, A7, TT and Q7 vehicles and is included with an Audi connect[®] subscription. Other models (allroad, A3, A4, A5, A8, Q3 and Q5) include SiriusXM[®] Traffic for four years with the purchase of the vehicle. 8. High-performance tires are designed for better performance and handling in warm climates. When driving in cold, snowy or icy weather, you should equip your vehicle with four all-season or winter tires, which offer better traction under those conditions. We suggest you use the Audi-recommended winter or all-season tires specified for your Audi. High-performance tires also have a lower aspect ratio that aids performance and handling. Driving over rough or damaged road surfaces, as well as debris, curbs and other obstacles, can cause serious damage to wheels, tires, vehicle body and suspension parts. Be careful to avoid road hazards and reduce your speed, especially if your vehicle is equipped with low-profile tires. Please also remember when making your selection that, while these tires deliver responsive handling, they may ride less comfortably and make more noise than others. Finally, these tires may wear more quickly than other choices. It is important that the inflation pressure is regularly checked and maintained at recommended levels. 9. When driving during cold, snowy or icy weather conditions, ensure that your vehicle is equipped with appropriate all-season or winter tires. Even with appropriate tires, you must always drive in a manner appropriate for the weather, visibility and road conditions.

Available Models



Safety / Security



Driver Assistance / Innovation



Exterior



Interior / Seating



Infotainment / Technology



Stand-alone Options



Build your 2017 A4

Audi A4 Specifications

A4 Premium



A4 Premium Plus



A4 Prestige



Stand-alone Options

- > Parking sensors front and rear
- > Heated front seats
- > 245/40 R18 93Y summer performance tires¹ (with 18" Wheel package)
- > High-gloss Dark Brown Walnut Wood
- > Natural Gray Oak Wood inlays
- > Rear thorax side airbags²

- > 245/40 R18 summer performance tires³
- > High-gloss Dark Brown Walnut Wood
- > Natural Gray Oak Wood inlays
- > Rear thorax side airbags²

- > Adaptive damping suspension
- > 245/40 R18 summer performance tires³
- > High-gloss Dark Brown Walnut Wood
- > Natural Gray Oak Wood inlays
- > Rear thorax side airbags²

1 High-performance tires are designed for better performance and handling in warm climates. When driving in cold, snowy or icy weather, you should equip your vehicle with four all-season or winter tires, which offer better traction under those conditions. We suggest you use the Audi-recommended winter or all-season tires specified for your Audi. High-performance tires also have a lower aspect ratio that aids performance and handling. Driving over rough or damaged road surfaces, as well as debris, curbs and other obstacles, can cause serious damage to wheels, tires, vehicle body and suspension parts. Be careful to avoid road hazards and reduce your speed, especially if your vehicle is equipped with low-profile tires. Please also remember when making your selection that, while these tires deliver responsive handling, they may ride less comfortably and make more noise than others. Finally, these tires may wear more quickly than other choices. It is important that the inflation pressure is regularly checked and maintained at recommended levels. 2 Airbags are supplemental restraints only and will not deploy in all crash circumstances. Always use safety belts and seat children only in the rear, using restraint systems appropriate for their size and age. 3 High-performance tires are designed for better performance and handling in warm climates. When driving in cold, snowy or icy weather, you should equip your vehicle with four all-season or winter tires, which offer better traction under those conditions. We suggest you use the Audi-recommended winter or all-season tires specified for your Audi. High-performance tires also have a lower aspect ratio that aids performance and handling. Driving over rough or damaged road surfaces, as well as debris, curbs and other obstacles, can cause serious damage to wheels, tires, vehicle body and suspension parts. Be careful to avoid road hazards and reduce your speed, especially if your vehicle is equipped with low-profile tires. Please also remember when making your selection that, while these tires deliver responsive handling, they may ride less comfortably and make more noise than others. Finally, these tires may wear more quickly than other choices. It is important that the inflation pressure is regularly checked and maintained at recommended levels.

Available Models



Safety / Security



Driver Assistance / Innovation



Exterior



Interior / Seating



Infotainment / Technology



Packages



Build your 2017 A4

Technical Specifications

Engineering | Performance

A4 2.0T

Engine type	Four-cylinder
Engine block/Cylinder head	Cast-iron/Aluminum-alloy
Displacement (cc)/Bore and stroke (mm)	1,984/82.5 x 92.8
Horsepower (@ rpm)	252 @ 5,000–6,000
Torque (lb-ft @ rpm)	273 @ 1,600–4,500
Compression ratio	9.6:1
Valvetrain	16-valve DOHC with Audi valvelift system
Induction/Fuel injection	Turbocharged/TFSI®
Start-stop engine efficiency system	■
Acceleration with front-wheel drive/quattro® all-wheel drive (0–60 mph)	6.1/5.7 seconds
Top track speed ¹	130 mph

Transmission | Drivetrain

Seven-speed S tronic® dual-clutch automatic transmission with front-wheel drive	■
Seven-speed S tronic® dual-clutch automatic transmission with quattro® all-wheel drive	Available

Body | Suspension | Chassis

ultra® lightweight technology - multi-material body construction (steel and aluminum composition)	■
Five-link front suspension	■
Five-link rear suspension	■
Sport suspension	Available
Adaptive damping suspension	Available
Ventilated front disc/Ventilated rear disc brakes (in)	13.3/13.0
Electromechanical power steering system	■
Steering ratio	15.9:1
Turning circle, curb-to-curb (ft)	38.1

[Search A4 Inventory ↗](#)

[Find A Local Dealer ↗](#)

■ Standard — Not applicable NA Information not available at time of printing

¹ Top track speed is electronically limited in the U.S. Always obey all speed and traffic laws.

Technical Specifications

Exterior measurements

	A4 2.0T
Wheelbase (in)	111.0
Length (in)	186.1
Height (in)	56.2
Overall width with mirrors (in)	79.6
Overall width without mirrors (in)	72.5
Track (in, front/rear)	61.9/61.2
Curb weight with front-wheel drive (lb)	3,483
Curb weight with quattro® all-wheel drive (lb)	3,626
Drag coefficient (Cw)	0.27

Interior measurements

Head room with sunroof (in, front/rear)	38.9/37.4
Leg room (in, front/rear)	41.3/35.7
Shoulder room (in, front/rear)	55.9/54.5
Cargo volume (cu ft)	13.0
Seating capacity	5

EPA mileage estimates | Capacities | Emissions

S tronic® dual-clutch automatic transmission with front-wheel drive (city/highway/combined) ¹	NA
S tronic® dual-clutch automatic transmission with quattro® all-wheel drive (city/highway/combined) ¹	NA
Engine oil (qt)	5.5
Fuel (gal)	15.3
Recommended fuel	Premium
Emissions rating	LEV III/Tier 3 125

Build Your 2017 A4 [↗](#)

■ Standard — Not applicable NA Information not available at time of printing

¹ 2017 EPA estimates not available at time of printing. See www.fueleconomy.gov for updated information. Your mileage will vary and depends on several factors, including your driving habits and vehicle condition.



Now for the finishing touches.

You're a try-anything-once, never-sit-still, give-it-your-all kind of person. Life doesn't just string you along; you strive to take life further. Audi Genuine Accessories can help you do just that. For personalizing, protecting and showing your Audi pride, our accessories were made just for you.





// Audi Genuine Sport and Design Accessories

For a bolder appearance or a finishing touch, we have a solution that helps make every mile more enjoyable—and more yours.

- ▶ Stylish wheel designs
- ▶ Exhaust tips
- ▶ License plate frames

// Audi TravelSpace Transport Accessories

When on the go, help make sure your gear fits with a variety of intelligent and innovative solutions.

- ▶ Bike and ski racks
- ▶ Rooftop cargo carriers
- ▶ In-vehicle cargo bags

// Audi Guard Comfort and Protection Accessories

Help protect what you love. Use Audi Guard Comfort and Protection Accessories to help keep your Audi looking like new—inside and out.

- ▶ Floor mats
- ▶ Splash guards
- ▶ Cargo mats

// Audi Guard Car Care Products

Your Audi A4 deserves the very best and this is the only car care line designed specifically for Audi.

- ▶ Leather care
- ▶ Insect remover
- ▶ Detailing tools
- ▶ Winter protection

visit parts.audiusa.com for more.





TAP IMAGES FOR DETAILS



// **Small cargo carrier**

Use 12.7 cu ft of extra storage to get started on your weekend getaway.

Size: 70" long, 33" wide, 15" high.



visit parts.audiusa.com for more.





// **Aluminum bike rack¹**

Help protect your other ride. This locking holder fits 20- to 80-mm bike frames with both wheels on the bike and helps keep the bike upright as you secure it in place.

visit parts.audiusa.com for more. 

¹ All roof-rack system attachments require the base carrier bars. All attachments sold separately. Recreational equipment, sporting equipment and luggage not included.

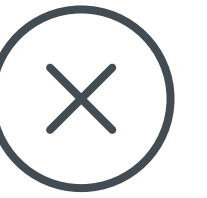

// Ski and snowboard racks¹

These racks help transport your equipment to the slopes. The standard attachment (shown) holds two sets of skis or two snowboards. A deluxe attachment, sold separately, holds up to three sets of skis or up to four snowboards.

visit parts.audiusa.com for more.



¹ All roof-rack system attachments require the base carrier bars. All attachments sold separately. Recreational equipment, sporting equipment and luggage not included.



// A4 winter wheel and tire package

Adding style and performance, this winter wheel and tire package features Audi Original winter tires specifically engineered to help improve traction and handling in snow and ice—and even on dry roads—in temperatures below 45°F.¹

visit parts.audiusa.com for more.



¹ Even with appropriate tires, you must always drive in a manner appropriate for the weather, visibility and road conditions, and you must maintain more distance from other vehicles since braking distances will be longer on ice- and snow-covered roads.



// Carbon fiber mirror caps

Built from the same materials as the famed Audi Le Mans prototype race cars, these strong, light-weight, eye-catching accents display carbon fiber technology in all its glory.

visit parts.audiusa.com for more.





// All-weather floor mats

No matter where the day takes you, the floor mats feature a deep-ribbed, channeled design that helps protect your vehicle's floor and carpeting from the elements. Black mats are available in sets of two for front or rear. Front mats feature the Audi A4 logo.

visit parts.audiusa.com for more.





// All-weather cargo mat

Custom fit for your A4, the raised outside edge of the cargo mat helps contain spills and protect cargo-area carpeting from stains. The textured material helps control load shifting.

visit parts.audiusa.com for more.



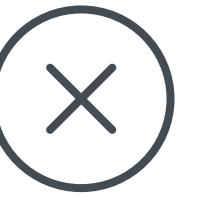

// Carbon fiber trunk lid spoiler¹

Add a sporty accent to your A4. This spoiler is lightweight, but also strong and durable with the sleek, sophisticated look that carbon fiber offers. Matches the mirror caps.

visit parts.audiusa.com for more.



¹ Professional installation required. See your authorized Audi dealer for details.



// Men's Ingolstadt jacket

This three-layer performance soft-shell jacket, with a bonded fleece lining and an interior membrane, features custom map artwork in front and the Audi rings logo on the sleeve.



// Gunmetal key holder

Represent your Audi in style. This dark-gray metal key holder features the Audi rings logo with a pull-and-twist mechanism.



// Men's leather chronograph watch

Add a little extra style to your everyday attire. This watch has a black leather band, a gray dial and a chronograph function with the Audi rings logo.

visit audicollectionusausa.com for more.



Explore more in Audi library

A4 2017

Audi of America
Audiusa.com
Facebook.com/Audi

Tap here for important information about this brochure. >>

A4 2017

Audi of America
Audiusa.com
Facebook.com/Audi

Note: A word about this brochure. Audi of America, Inc., believes the specifications in this brochure to be correct at the time of printing. However, specifications, standard equipment, options, fabrics, and colors are subject to change without notice. Some equipment may be unavailable when your vehicle is built. Please ask your dealer for advice concerning current availability of standard and optional equipment, and your dealer will verify that your vehicle will include the equipment you ordered. Vehicles in this brochure are shown with optional equipment. See your dealer for complete details on the Audi New Vehicle Limited Warranty, twelve-year limited warranty against corrosion perforation, and Audi 24/7 Roadside Assistance. (Roadside assistance coverage provided by Road America in the U.S. Certain conditions apply; see your dealer for details.) Tires supplied by various manufacturers. "Audi," all model names, "Audi connect," "Audi pre sense," "Audi Sport," "MMI," "quattro," "S line," "S tronic," "Sideguard," "Single-frame," "TFSI," "ultra" and the four rings logo are registered trademarks of AUDI AG. "Apple" and "App Store" are registered trademarks of Apple Inc. "Bang & Olufsen" is a registered trademark of Bang & Olufsen. The BLUETOOTH word mark and logos are owned by the Bluetooth SIG, Inc., and any use of such marks by AUDI AG is under license. "Facebook" is a registered trademark of Facebook, Inc. "Google Play" is a trademark of Google Inc. © 2016 Google Inc. All rights reserved. "HomeLink" is a registered trademark of Gentex Corporation. "INRIX XD" is a registered trademark of INRIX, Inc. "SiriusXM" and all related marks and logos are trademarks of Sirius XM Radio Inc. and its subsidiaries. "Wi-Fi" is a registered trademark of the Wi-Fi Alliance. All other trademarks are the property of their respective owners. Some European models shown. Some features may not be available at time of order.

