









-  Airbag
-  Gas generator
-  Seat belt pretensioner
-  SRS control unit
-  Active pedestrian protection system
-  Gas strut / Pre-loaded spring
-  High strength zone
-  Low-voltage battery
-  Petrol fuel tank



1. Identification / recognition

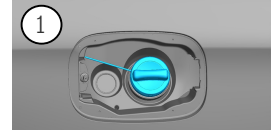
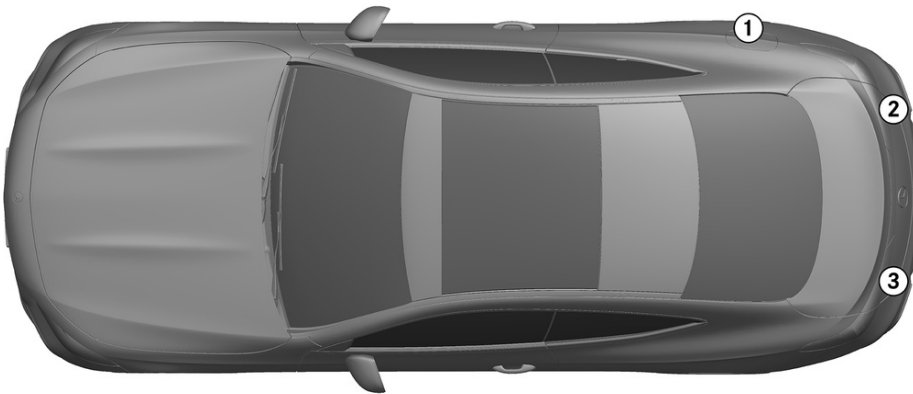

2. Immobilisation / stabilisation / lifting

Parking brake

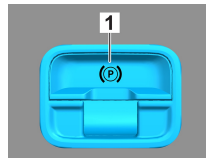
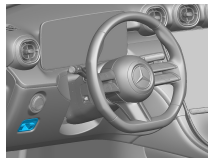
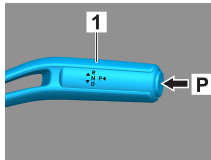
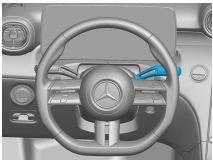

Press the P switch on the gear selector (1). The parking brake is automatically activated. Electric parking brake (1)

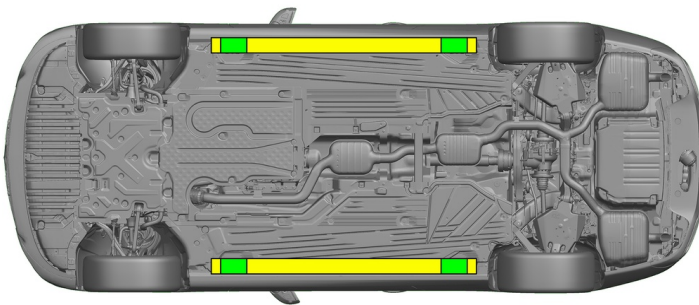

- Suitable lifting points
- Suitable stabilisation points on the side

3. Disable direct hazards / safety regulations

Switch off the ignition:

1. Press the START/STOP button without actuating the service brake.
2. Keep the electronic vehicle key at a distance of at least 5 m.

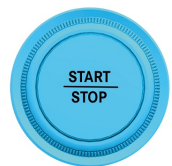
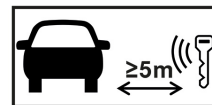

Disconnecting the 12 V battery

1. Remove the cover from the 12-volt battery in the boot.
2. Disconnect the negative cable of the 12-volt battery at the screw connection and secure it against unintentional contact.



The passive safety systems (airbags and seat belt pretensioners) are deactivated after disconnecting 12V battery.



10 seconds after disconnecting the 12V battery, the 48V system is automatically deactivated.



Disconnecting the 48 V battery

1. Disconnect the negative cable of the 48-volt battery at the screw connection and secure it against unintentional contact.

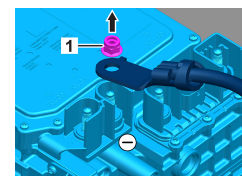



4. Access to the occupants

When freeing the occupants, areas of the bodywork which are made from high-strength steels and the components of the restraint systems (in particular pyrotechnic elements) must be taken into consideration in accordance with the information on page 1.

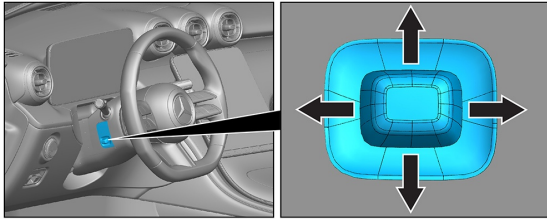

Steering wheel adjustment

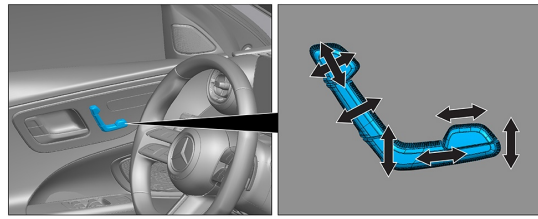

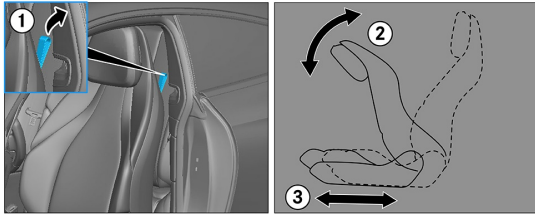

Seat adjustment (electric)



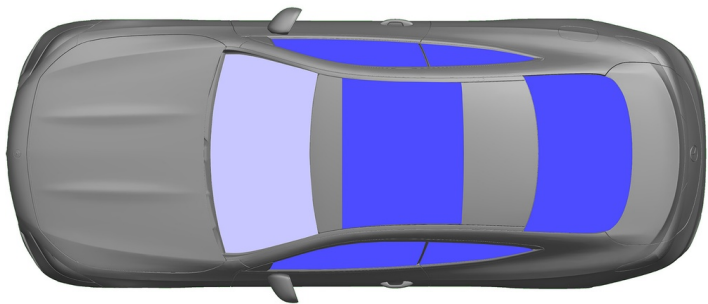















Folding front seat backrest



 VSG: Laminated safety glass

 ESG: Tempered glass

5. Stored energy / liquids / gases / solids

	    	48 V Li-ion
	  	12 V AGM
	 	66 L
	  	610 ± 10 g

6. In case of fire



Use large volumes of water (H₂O) to extinguish a vehicle fire.
Use large volumes of water (H₂O) to cool the Li-ion battery.



Warning: Ignition of the battery possible



7. In case of submersion

There is no risk of voltage in the bodywork. After recovery of the vehicle:

1. Allow the water to drain out of the interior.
2. Commence deactivation of the 12 V/48 V electrical system (see Section 3).



8. Towing / transportation / storage

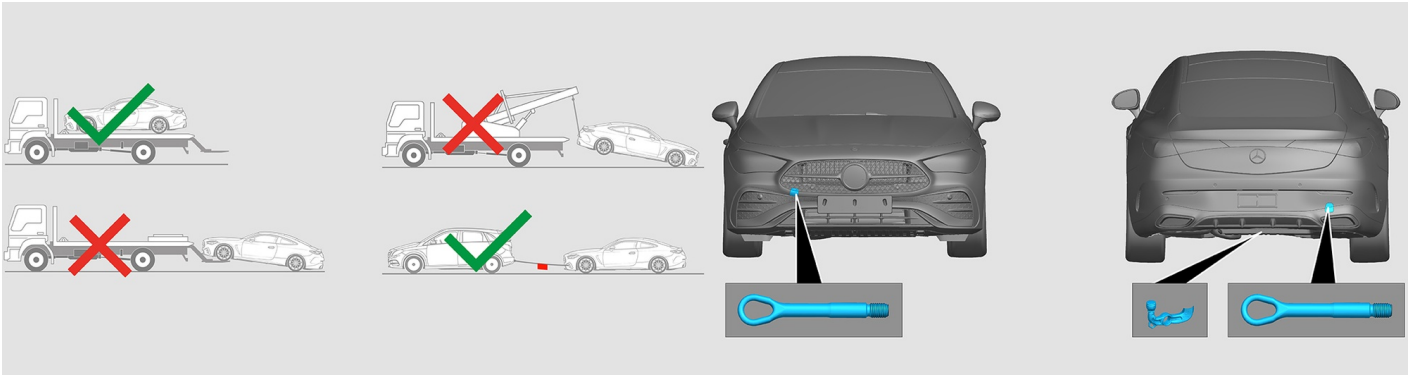

9. Important additional information







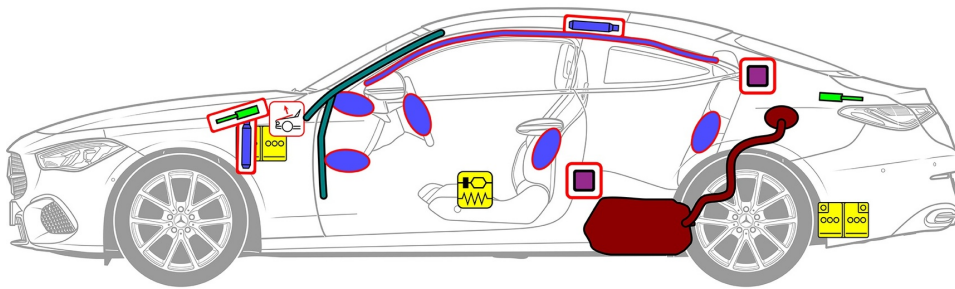
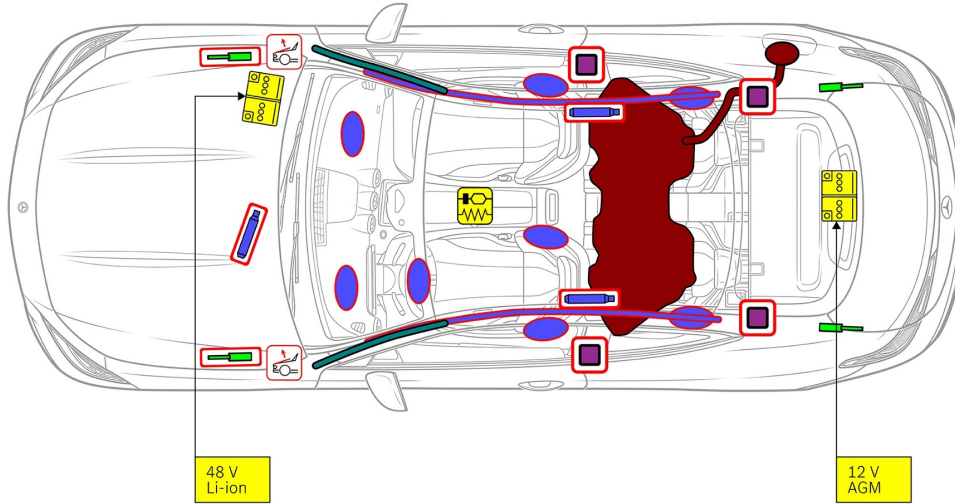

You can find more information in the [Guidelines for car towing services](#).

Note: Please see our [emergency response guide](#) for more information

10. Explanation of pictograms used

	Vehicle on fuel of liquid group 2		General warning sign		Flammable		Hazardous to the human health
	Corrosives		Acute toxicity		Explosive		Use water to extinguish the fire
	Use dry foam to extinguish the fire		Use wet foam to extinguish the fire		Bonnet		Boot
	Remove smart key		Air-conditioning component		Warning; low temperature		



-  Airbag
-  Gas generator
-  Seat belt pretensioner
-  SRS control unit
-  Active pedestrian protection system
-  Gas strut / Pre-loaded spring
-  High strength zone
-  Low-voltage battery
-  Petrol fuel tank



1. Identification / recognition

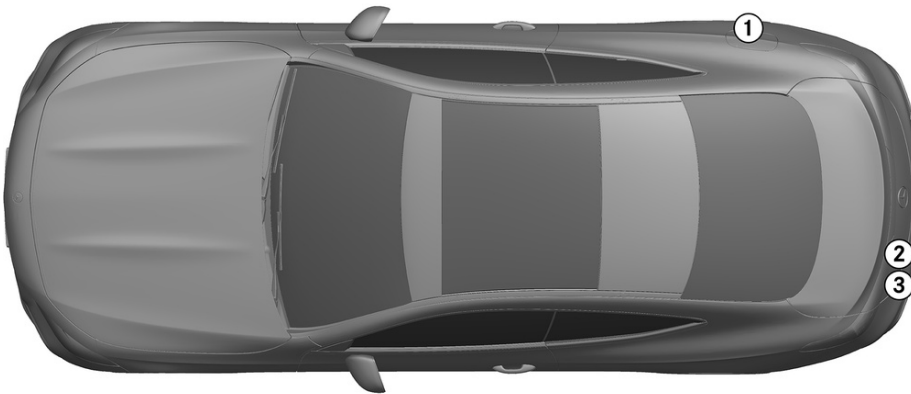

② CLE 200



③ CLE 260

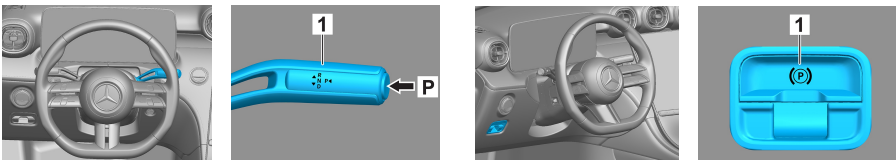

2. Immobilisation / stabilisation / lifting

Parking brake

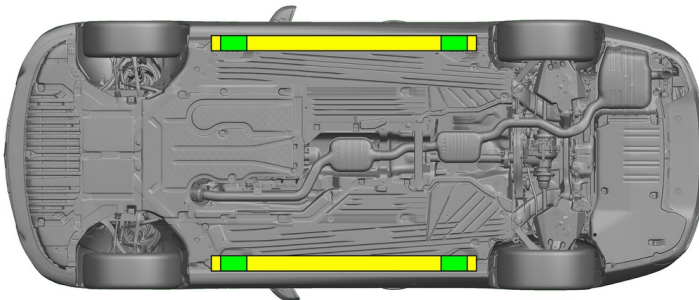

Press the P switch on the gear selector (1). The parking brake is automatically activated. Electric parking brake (1)



 Suitable lifting points
 Suitable stabilisation points on the side

3. Disable direct hazards / safety regulations

Switch off the ignition:

- 1. Press the START/STOP button without actuating the service brake.
- 2. Keep the electronic vehicle key at a distance of at least 5 m.

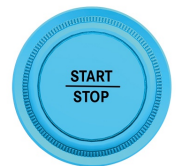
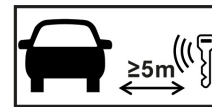

Disconnecting the 12 V battery

- 1. Remove the cover from the 12-volt battery in the boot.
- 2. Disconnect the negative cable of the 12-volt battery at the screw connection and secure it against unintentional contact.



The passive safety systems (airbags and seat belt pretensioners) are deactivated after disconnecting 12V battery.



10 seconds after disconnecting the 12V battery, the 48V system is automatically deactivated.



Disconnecting the 48 V battery

- 1. Disconnect the negative cable of the 48-volt battery at the screw connection and secure it against unintentional contact.

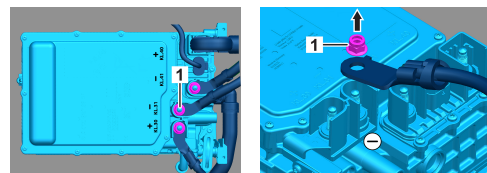

4. Access to the occupants

When freeing the occupants, areas of the bodywork which are made from high-strength steels and the components of the restraint systems (in particular pyrotechnic elements) must be taken into consideration in accordance with the information on page 1.

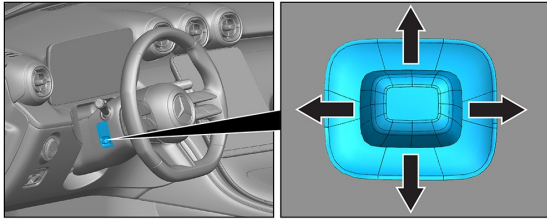

Steering wheel adjustment

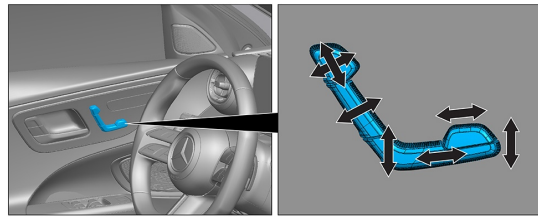

Seat adjustment (electric)

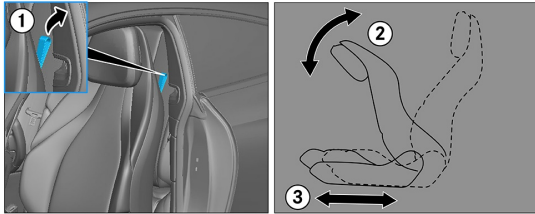

Folding front seat backrest

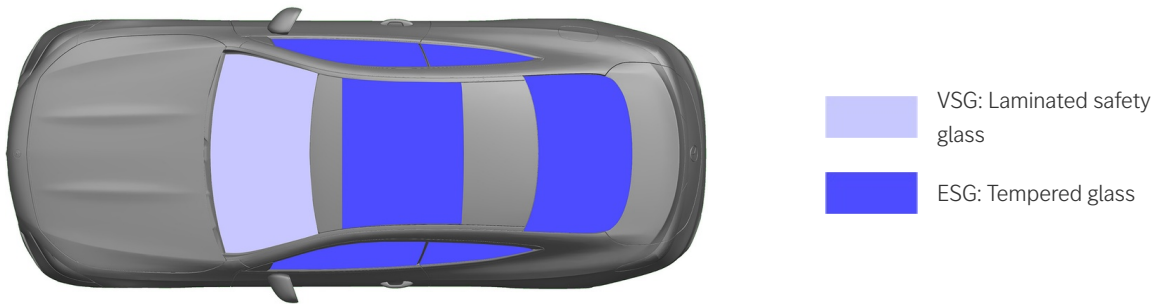

5. Stored energy / liquids / gases / solids

		48 V Li-ion
		12 V AGM
		66 L
		610 ± 10 g

6. In case of fire



Use large volumes of water (H₂O) to extinguish a vehicle fire.
Use large volumes of water (H₂O) to cool the Li-ion battery.



Warning: Ignition of the battery possible



7. In case of submersion

There is no risk of voltage in the bodywork. After recovery of the vehicle:

1. Allow the water to drain out of the interior.
2. Commence deactivation of the 12 V/48 V electrical system (see Section 3).



8. Towing / transportation / storage

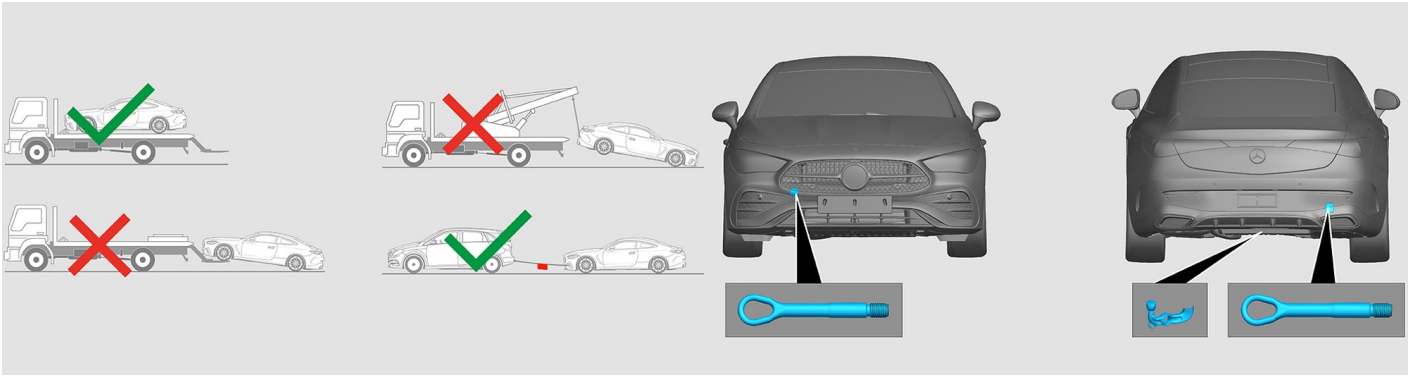

9. Important additional information

You can find more information in the [Guidelines for car towing services](#).

Note: Please see our [emergency response guide](#) for more information

10. Explanation of pictograms used

	Vehicle on fuel of liquid group 2		General warning sign		Flammable		Hazardous to the human health
	Corrosives		Acute toxicity		Explosive		Use water to extinguish the fire
	Use dry foam to extinguish the fire		Use wet foam to extinguish the fire		Bonnet		Boot
	Remove smart key		Air-conditioning component		Warning; low temperature		