

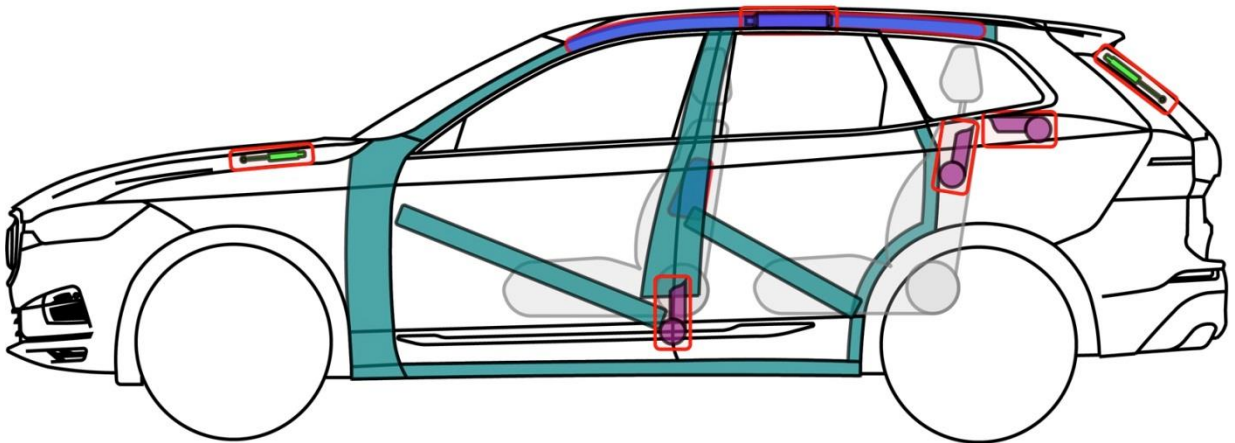

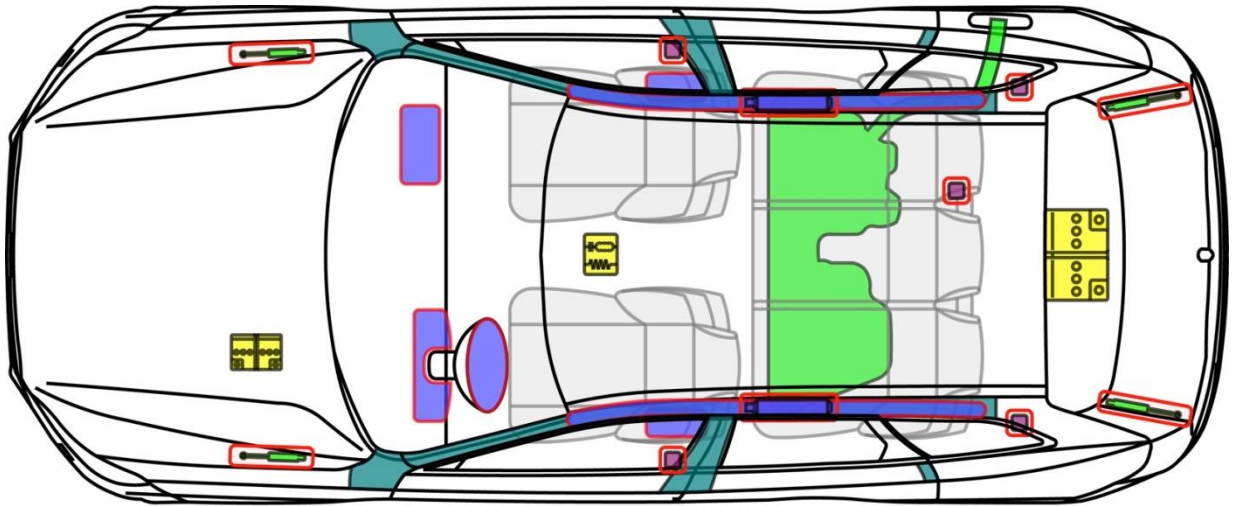





VOLVO XC60 (TYP U, 2017-)

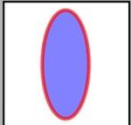
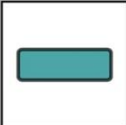

Note: The Rescue Sheet depicts a LHD vehicle (as allowed under the ISO 17840-1). All components (other than steering wheel and passenger airbag) are located in the same position in the Aust/NZ RHD model.

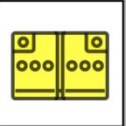
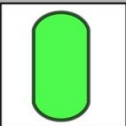

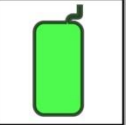
Legende

	Airbag		Karosserie- verstärkung		Steuergerät		mech. Sensor
	Gas- generator		Überroll- schutz		Batterie		Gastank
	Gurt- straffer		Gasdruck- dämpfer		Kraftstoff- tank		Sicherheits- ventil

VOLVO XC60 T8 TWIN ENGINE (TYP U, 2017-)



Note: The Rescue Sheet depicts a LHD vehicle (as allowed under the ISO 17840-1). All components (other than steering wheel and passenger airbag) are located in the same position in the Aust/NZ RHD model.

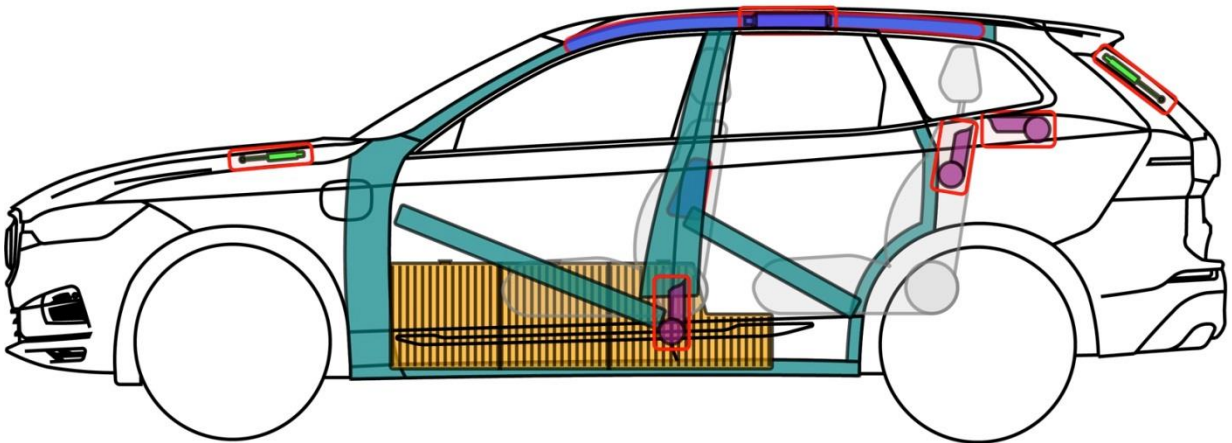
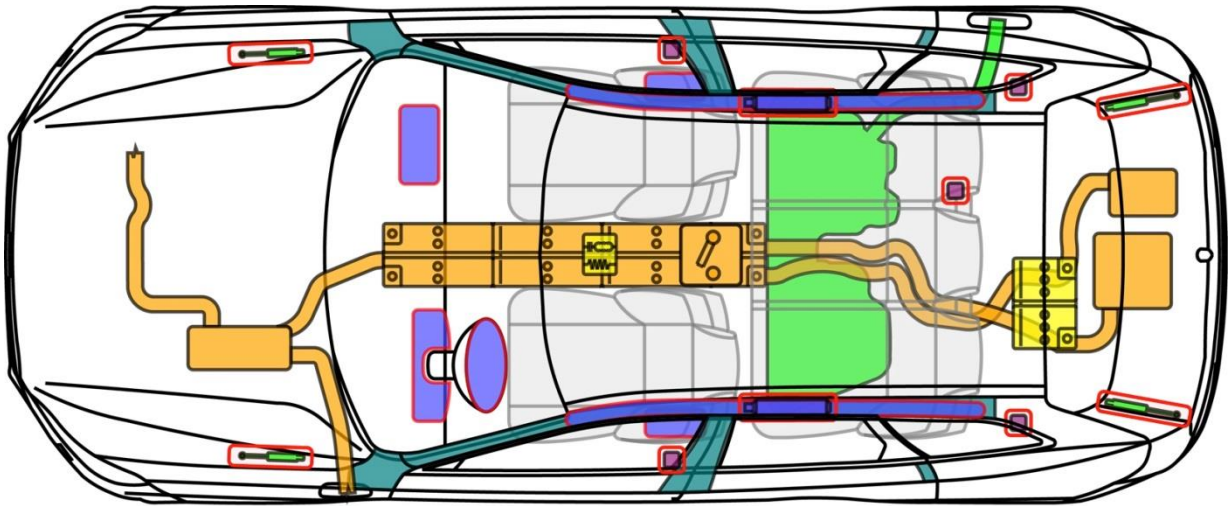

Legende

	Airbag		Karosserie- verstärkung		Steuergerät		Hochvolt- batterie
	Gas- generator		Überroll- schutz		Batterie		Hochvolt- leitung/ -komponente
	Gurt- straffer		Gasdruck- dämpfer		Kraftstoff- tank		HV- Trennstelle