

the CLERMONT

Plan Options

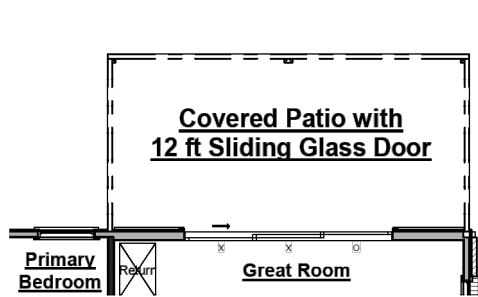

12ft Sliding Glass Door

- Adds 12ft sliding glass door & omits 6ft sliding door & (2) 2'-8" x 5'-0" windows from Great Room

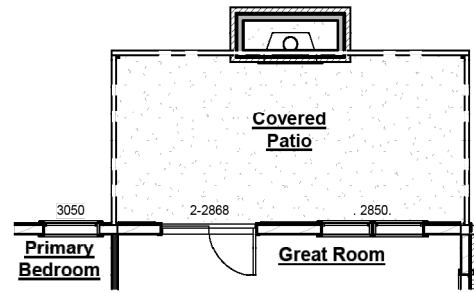

Outdoor Gas Log Fireplace

- Adds outdoor fireplace with siding or brick to match house, cedar beam mantel, firebox, gas logs & electrical outlet above fireplace

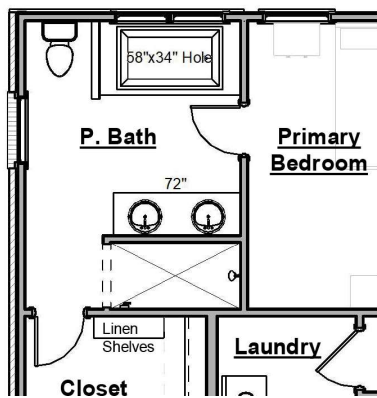

Primary Bathroom Tub

- Adds drop in tub with tile surround & (2) 2'-4" x 4'-0" windows above tub
- Omits toilet closet & 2'-0" x 3'-0" window, 2'-8" x 5'-0" window near shower
- Relocates shower & toilet location
- Reduces Primary Closet by 13sf

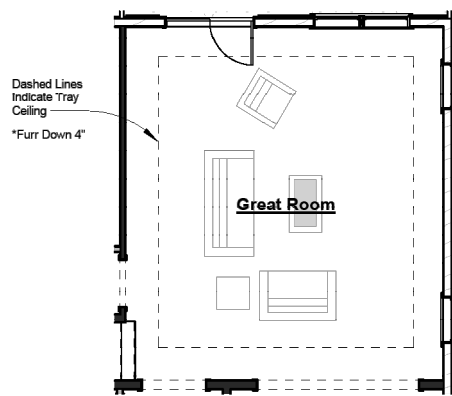

Great Room Tray Ceiling

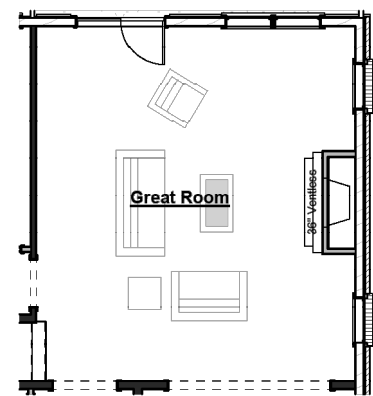

Great Room Fireplace Bump-In

- Adds fireplace to Great Room
- Includes trim-built mantel, firebox, 18" gas logs, tile surround, & electrical outlet above fireplace



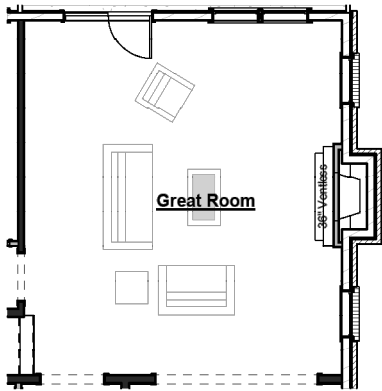

Great Room Fireplace Bump-Out

- Adds fireplace to Great Room
- Includes trim-built mantel, firebox, 18" gas logs, tile surround, & electrical outlet above fireplace

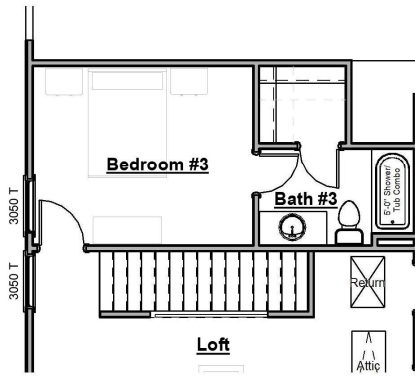

Private Bath #3 in Bedroom #3

- Adds full private bath with access from Bedroom #3
- Includes sink with base cabinet, mirror, toilet & fiberglass tub/shower
- Relocates Bedroom #3 entrance & closet entrance moves to Bath #3

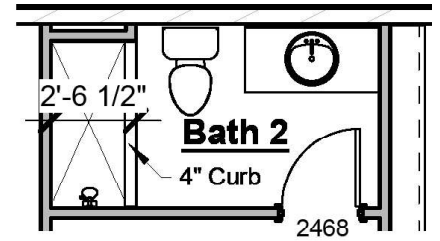

Bath 2 Tile Shower

- Replaces tub/shower unit with tile shower
- Includes tile walls & floor, shower head/valve & 4" curb
- Shower enclosure not included & may be purchased at design

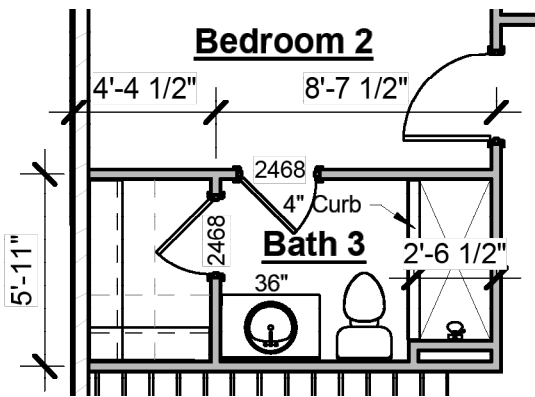

Bath 3 Tile Shower

- Replaces tub/shower unit with tile shower
- Includes tile walls & floor, shower head/valve & 4" curb
- Shower enclosure not included & may be purchased at design

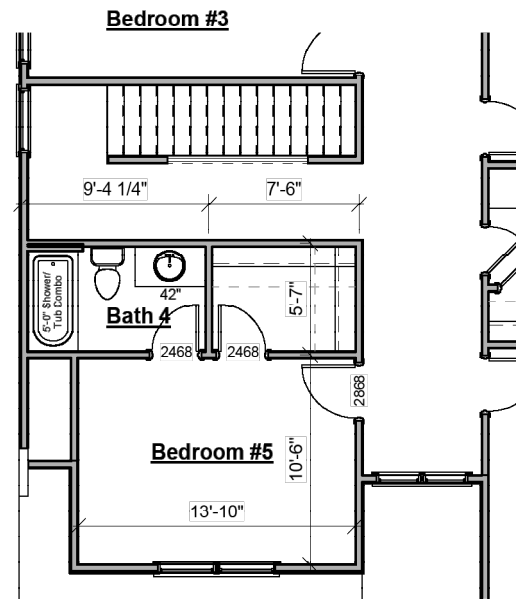

5th Bedroom with Bath #4

- Replaces Loft area with bedroom & full, private bath
- Includes carpet in bedroom
- Adds full bath with access from Bedroom #5
- Includes sink with cabinet base, mirror, toilet & fiberglass tub/shower
- Available for Clermont A only



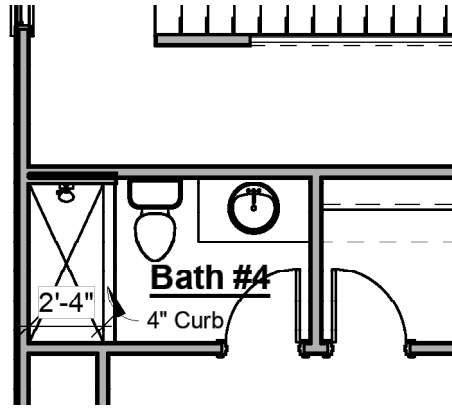

Bath 4 Tile Shower

- Replaces tub/shower unit with tile shower
- Includes tile walls & floor, shower head/valve & 4" curb
- Shower enclosure not included & may be purchased at design
- Available for Clermont A only

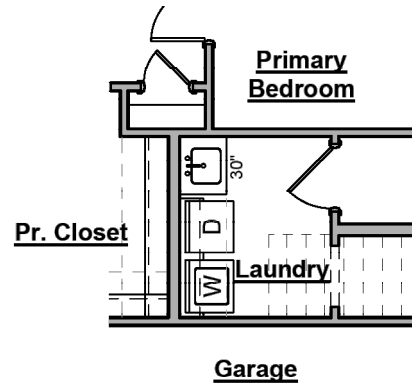

Laundry Room Sink

- Includes stainless sink with 30" base cabinet, cabinet hardware and countertop
- Cabinet base and countertop can be replaced with a freestanding utility sink

Other Options

- 4 Sides Brick (On Applicable Elevations)
- Guest Bath Syn-Iron Tub Shower with Tile Surround
- Pedestal Tubs

*Certain structural options may not be available due to lot restrictions and/or selection of other options. Prices subject to change without notice.



HARRIS DOYLE
HOMES



LIFE WELL CRAFTED



HARRISDOYLE.COM



facebook.com/harrisdoylehomes



@harrisdoylehomes
#harrisdoyle