

the MANSFIELD

Plan Options

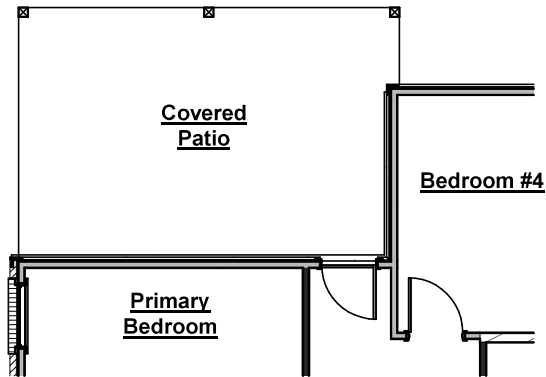

Covered Patio Extension

-Adds 75 sf of additional covered patio

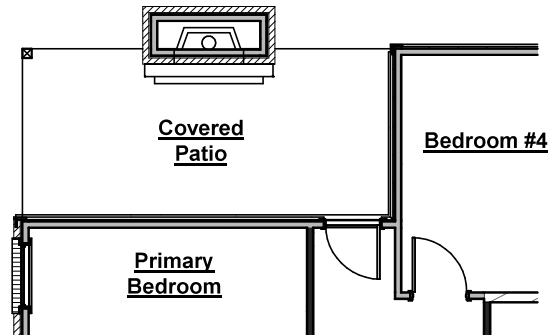

Outdoor Gas Log Fireplace

-Adds outdoor fireplace with brick to match house, cedar beam mantel, firebox, gas logs & electrical outlet above fireplace

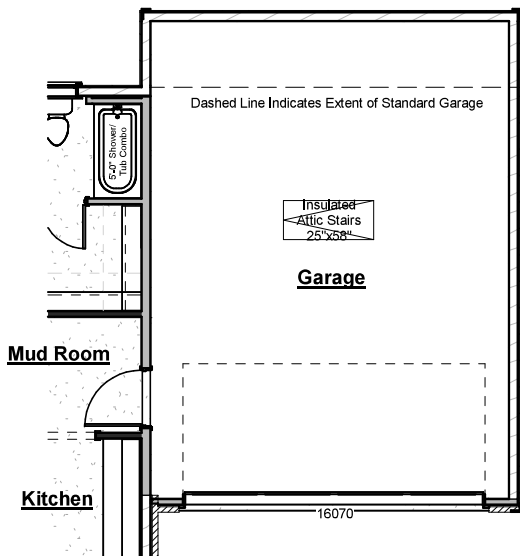

4ft Garage Extension

-Adds 80 sf to rear of garage

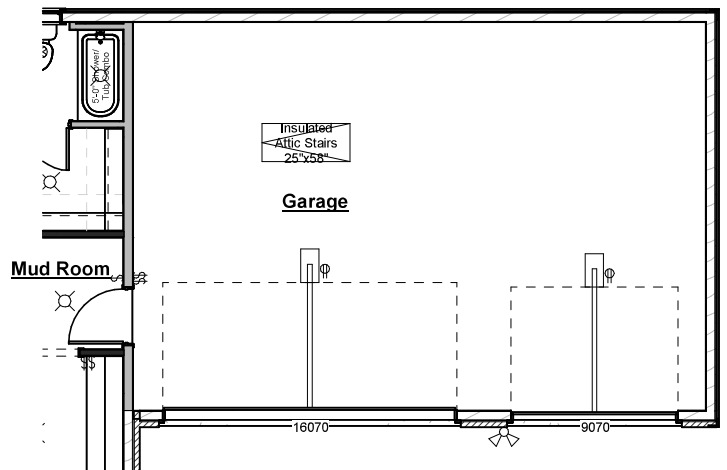

3rd Car Garage

-Adds 267 sf to garage
-Adds additional garage door



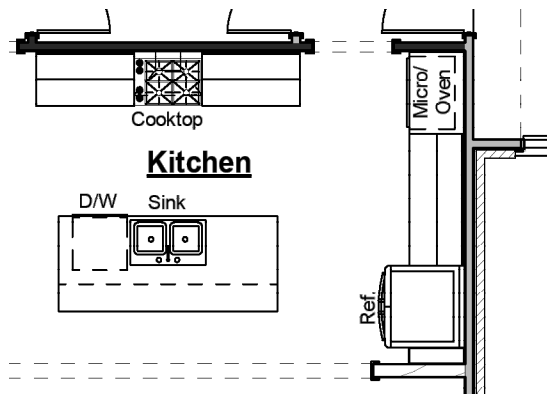

Chef's Kitchen with Single Oven

-Includes Frigidaire Gallery cooktop, wood hood, 1 wall ovens, microwave in island and dishwasher.

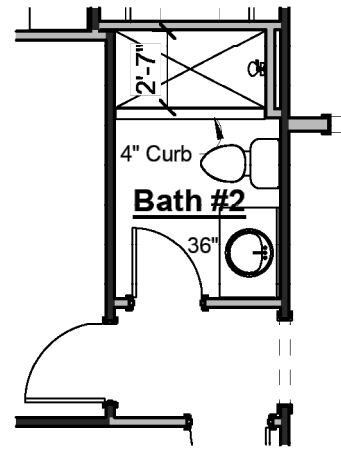

Bath 2 Tile Shower

-Replaces tub/shower unit with tile shower
 -Includes tile walls & floor, shower head/valve & 4" curb
 -Shower enclosure not included & may be purchased at design

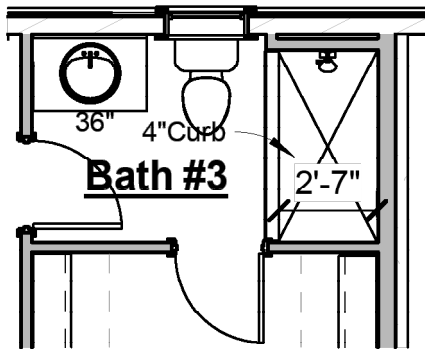

Bath 3 Tile Shower

-Replaces tub/shower unit with tile shower
 -Includes tile walls & floor, shower head/valve & 4" curb
 -Shower enclosure not included & may be purchased at design

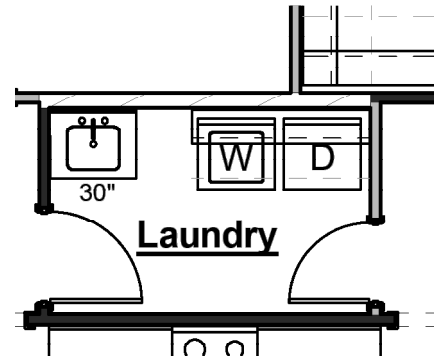

Laundry Room Sink

-Includes stainless sink with 30" base cabinet, cabinet hardware and countertop
 -Cabinet base and countertop can be replaced with a freestanding utility sink

Other Options

- 4 Sides Brick
- Guest Bath Syn-Iron Tub Shower with Tile Surround
- Pedestal Tubs

*Certain structural options may not be available due to lot restrictions and/or selection of other options. Prices subject to change without notice.



HARRIS DOYLE
 HOMES



LIFE WELL CRAFTED



HARRISDOYLE.COM



facebook.com/harrisdoylehomes



@harrisdoylehomes
 #harrisdoyle