

the MANSFIELD

Plan Options

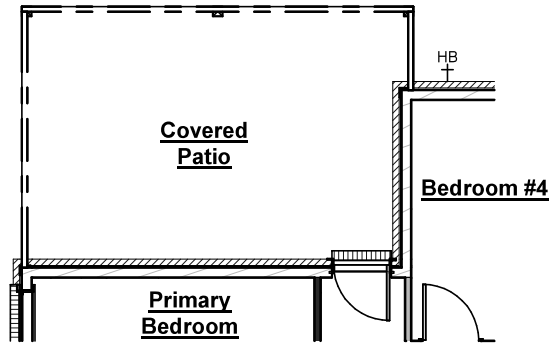

Covered Patio Extension

-Adds 75 sf of additional covered patio

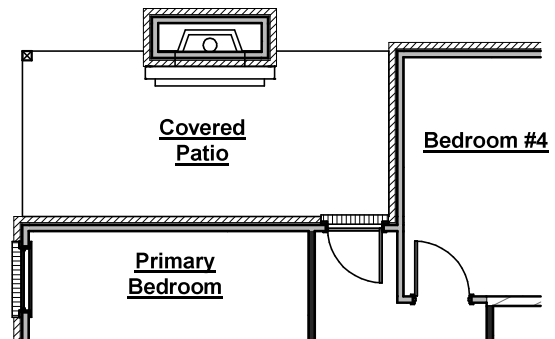

Outdoor Gas Log Fireplace

-Adds outdoor fireplace with brick to match house, cedar beam mantel, firebox, gas logs & electrical outlet above fireplace

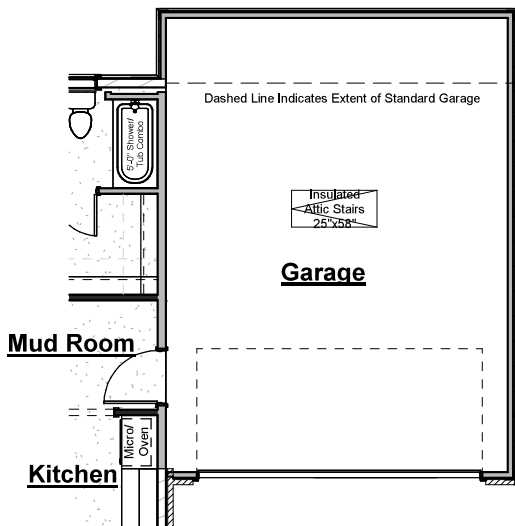

4ft Garage Extension

-Adds 80 sf to rear of garage

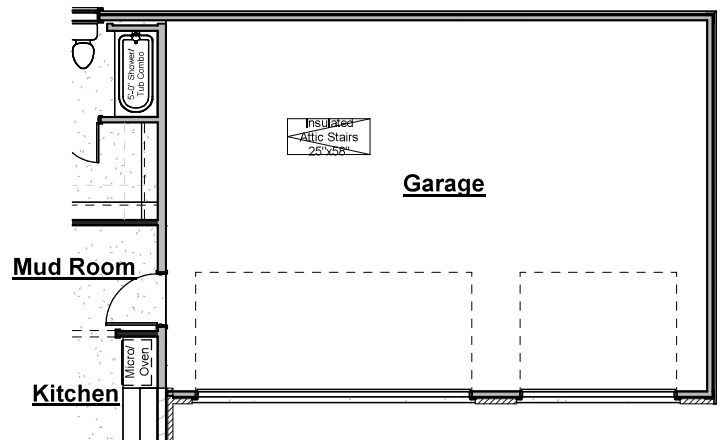

3rd Car Garage

-Adds 267 sf to garage
-Adds additional garage door



HARRIS DOYLE
HOMES

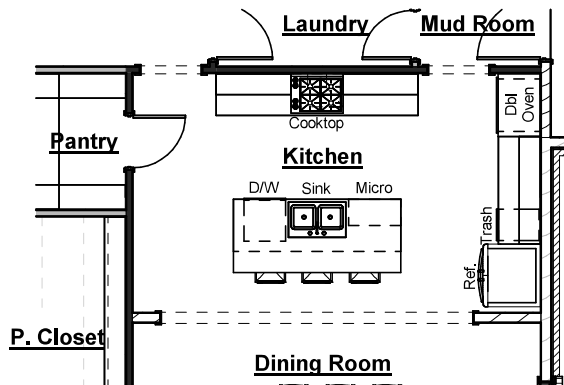

Chef's Kitchen with Double Oven

-Includes Frigidaire Gallery cooktop, wood hood, 2 wall ovens, microwave in island & dishwasher

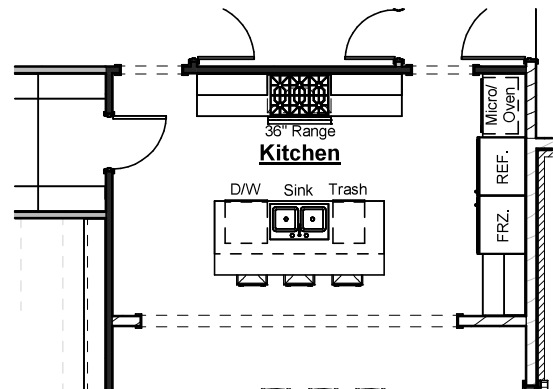

Gourmet Kitchen Option

-Includes Frigidaire 36" Professional slide-in range, wood hood, 1 wall ovens, microwave, dishwasher & built-in refrigerator & freezer
-Please see additional Gourmet Kitchen Structural Option sheet

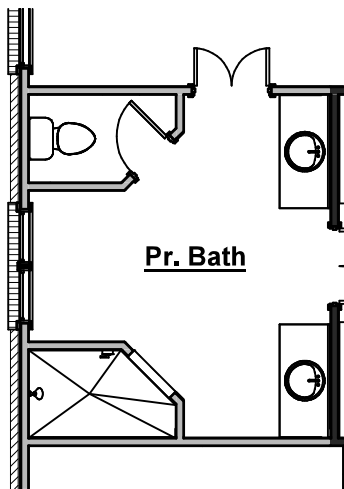

Primary Bath - Omit Tub

-Omits included tub
-Does not increase shower size

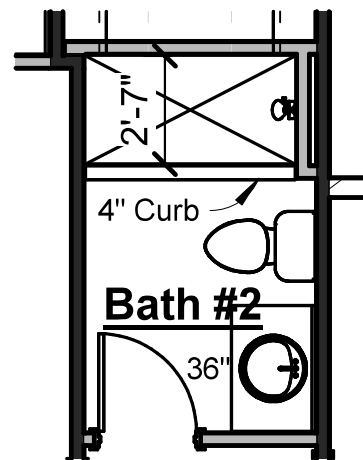

Bath 2 Tile Shower

-Replaces tub/shower unit with tile shower
-Includes tile walls & floor, shower head/valve & 4" curb
-Shower enclosure not included & may be purchased at design



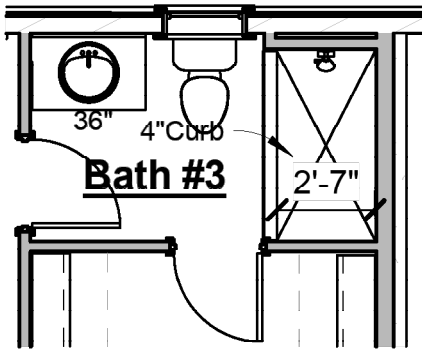

Bath 3 Tile Shower

- Replaces tub/shower unit with tile shower
- Includes tile walls & floor, shower head/valve & 4" curb
- Shower enclosure not included & may be purchased at design

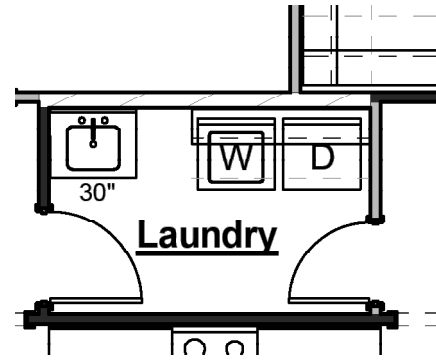

Laundry Room Sink

- Includes stainless sink with 30" base cabinet, cabinet hardware and countertop
- Cabinet base and countertop can be replaced with a freestanding utility sink

Other Options

- Guest Bath Syn-Iron Tub Shower with Tile Surround
- Pedestal Tubs
- 8' Interior Doors on Main Level

*Certain structural options may not be available due to lot restrictions and/or selection of other options. Prices subject to change without notice.



HARRIS DOYLE
HOMES



LIFE WELL CRAFTED



HARRISDOYLE.COM



facebook.com/harrisdoylehomes



@harrisdoylehomes
#harrisdoyle