

the BEDFORD

Plan Options

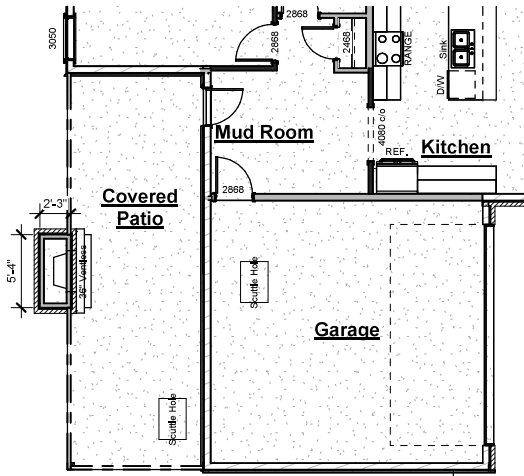

Outdoor Gas Log Fireplace

-Adds outdoor fireplace with brick to match house, cedar beam mantel, firebox, gas logs & electrical outlet above fireplace

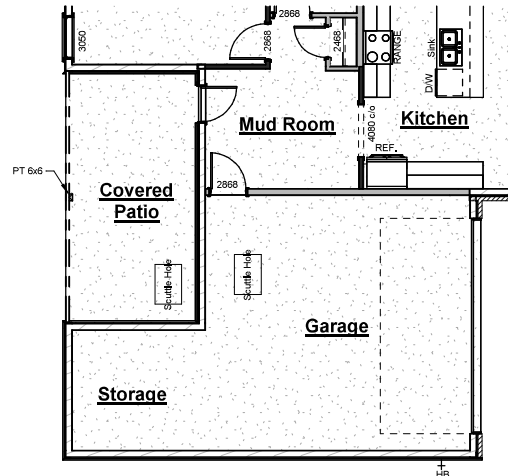

2-Car Garage with Storage

-Adds 134 sf to Garage by omitting space from Covered Patio
-Covered Patio is approx. 190 sf when this option is selected

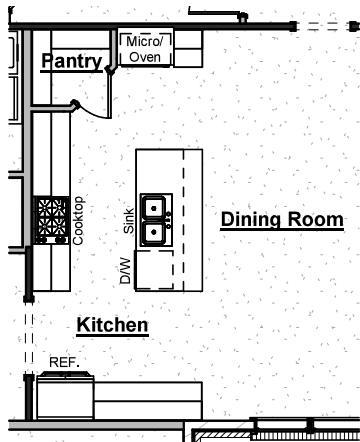

Chef's Kitchen with Single Oven

-Includes Frigidaire Gallery cooktop, wood hood, microwave above wall oven, dishwasher & cabinets in island
-Omits small pantry in Kitchen

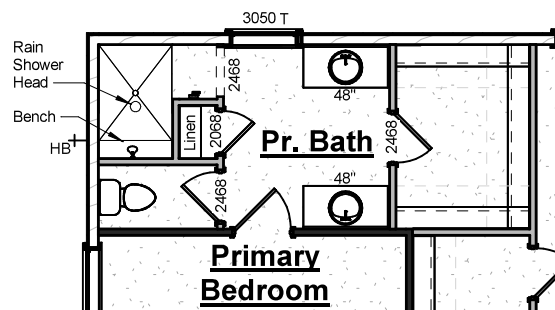

Primary Bath Grand Shower

- Replaces standard Drop-In tub with larger, walk-in shower
-Includes standard shower head controls, separate rain shower head controls, bench seat & Linen Closet



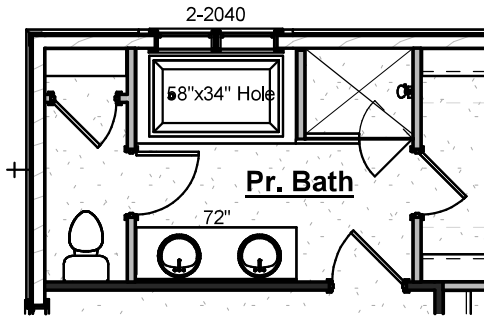

Primary Bathroom Tub

-Adds drop in tub with tile surround

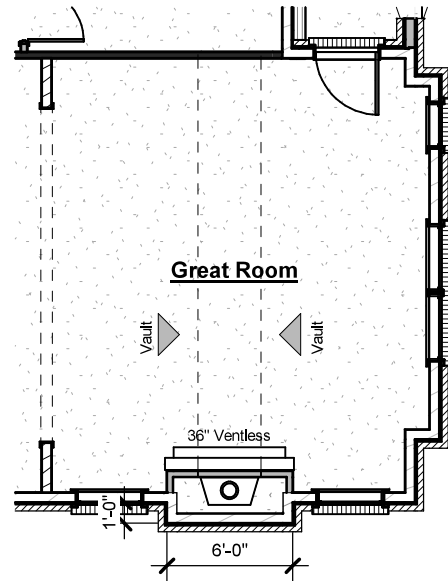

Great Room Fireplace

-Adds fireplace to Great Room
 -Includes trim-built mantel, firebox, 18" gas logs, tile surround & electrical outlet above fireplace

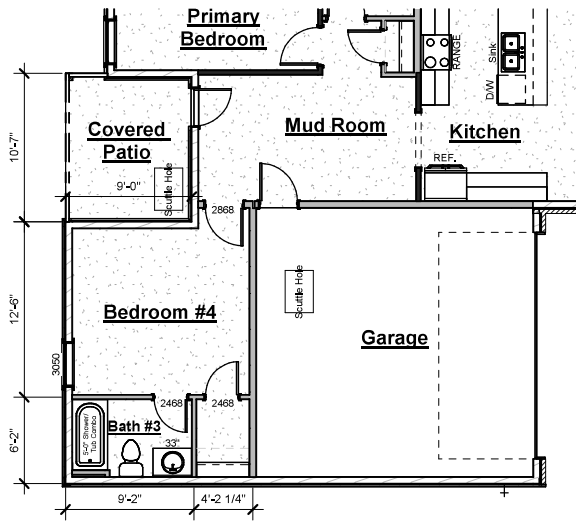

4th Bedroom with Private 3rd Bath

-Reduces Covered Patio by 254 sf
 -Adds 254 sf with additional bedroom & full private bath
 -Includes carpet in Bedroom
 -Adds full private bath with access from Bedroom #4
 -Includes sink with cabinet base, mirror, toilet & fiberglass shower/tub.

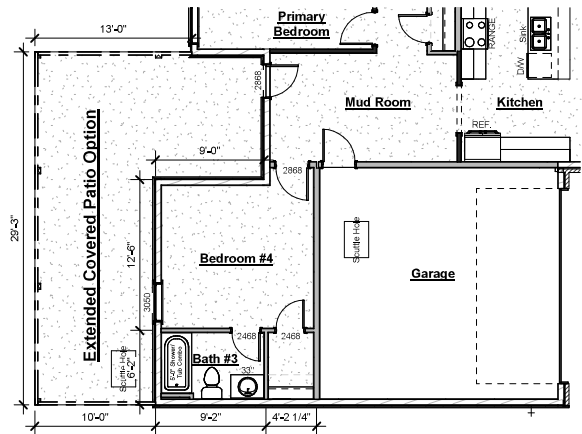

4th Bedroom with Private 3rd Bath with Extended Covered Patio

-Increases Covered Patio by 292 sf
 -Can only be selected with 4th Bedroom with Private 3rd Bath option



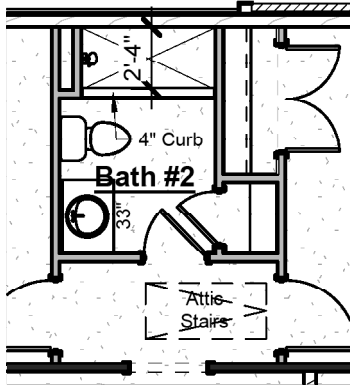

Bath 2 Tile Shower

- Replaces tub/shower unit with tile shower
- Includes tile walls & floor, shower head/valve & 4" curb
- Shower enclosure not included & may be purchased at design

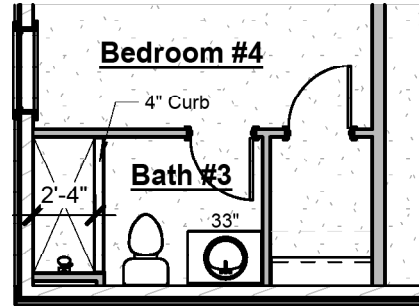

Bath 3 Tile Shower

- Replaces tub/shower unit with tile shower
- Includes tile walls & floor, shower head/valve & 4" curb
- Shower enclosure not included & may be purchased at design

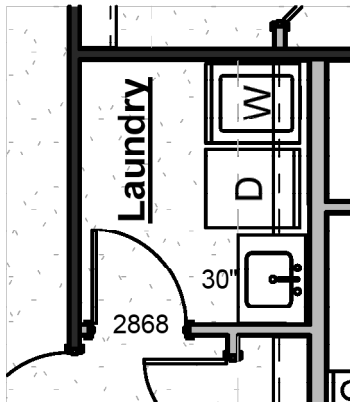

Laundry Room Sink Option

- Includes stainless sink with 30" base cabinet, cabinet hardware and countertop
- Cabinet base and countertop can be replaced with a freestanding utility sink

Other Options

- 4 Sides Brick (On Applicable Elevations)
- Guest Bath Syn-Iron Tub Shower with Tile Surround
- Pedestal Tubs

*Certain structural options may not be available due to lot restrictions and/or selection of other options. Prices subject to change without notice.



HARRIS DOYLE
HOMES



LIFE WELL CRAFTED



HARRISDOYLE.COM



facebook.com/harrisdoylehomes



@harrisdoylehomes
#harrisdoyle