

# SYNCRA SMART CONNECTION SYSTEM

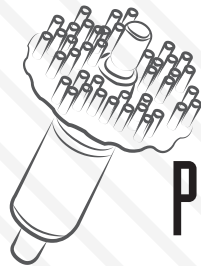

PSK *DC*  
mart

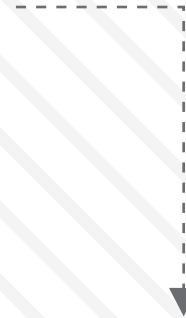
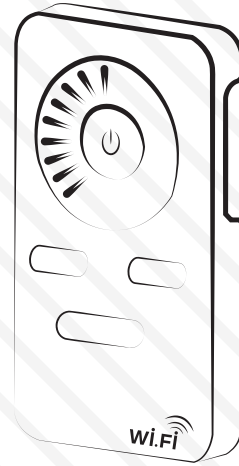
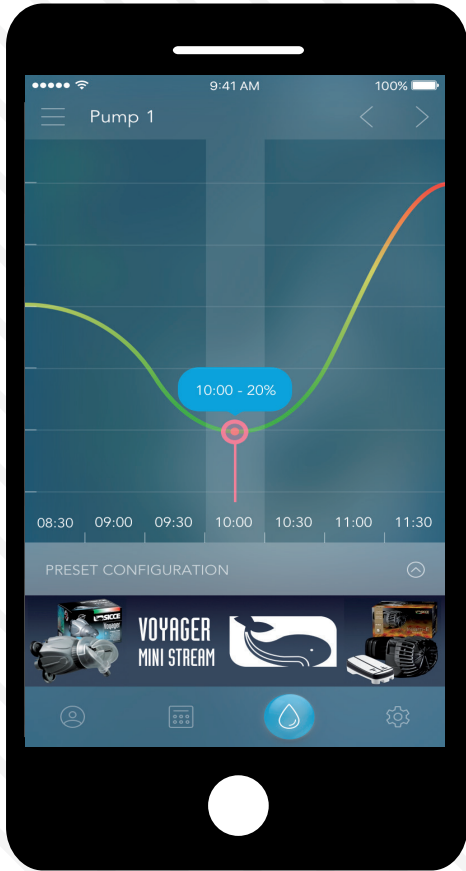
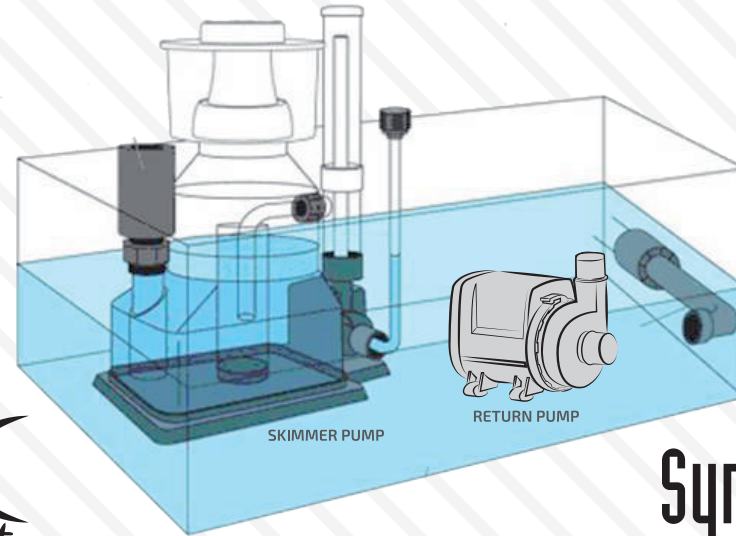

Syncra *DC*  
mart

# CONTROLΛLL APP.

Controllability any time anywhere

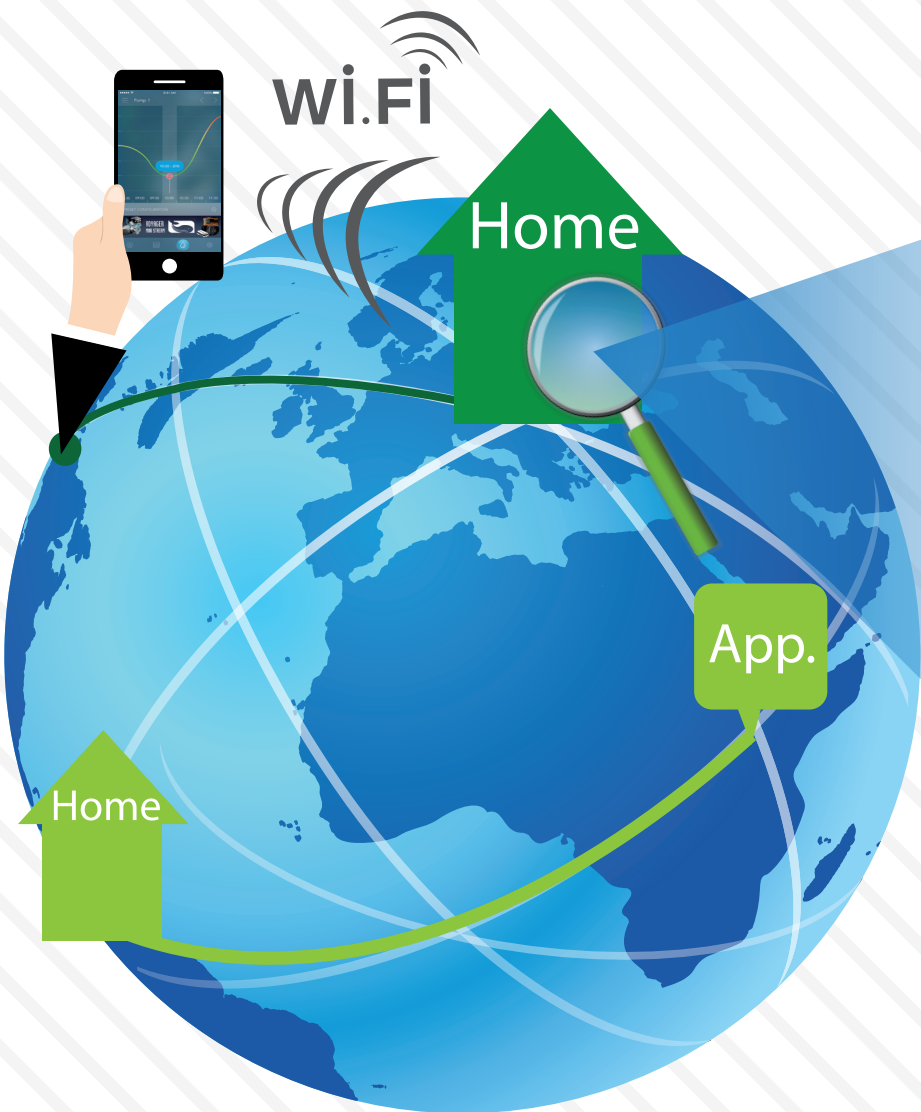

# SYNCRA SMART WI-FI CONTROLLER



MAGNETIC  
HOLDER

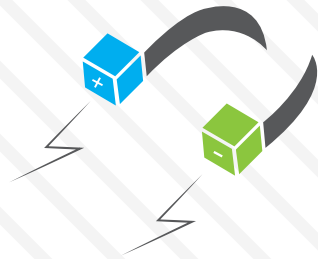

CAPACITIVE  
KEYBOARD

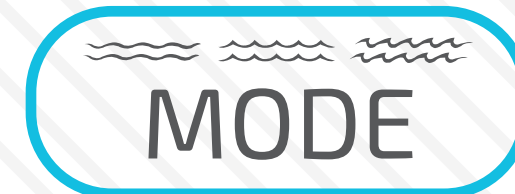
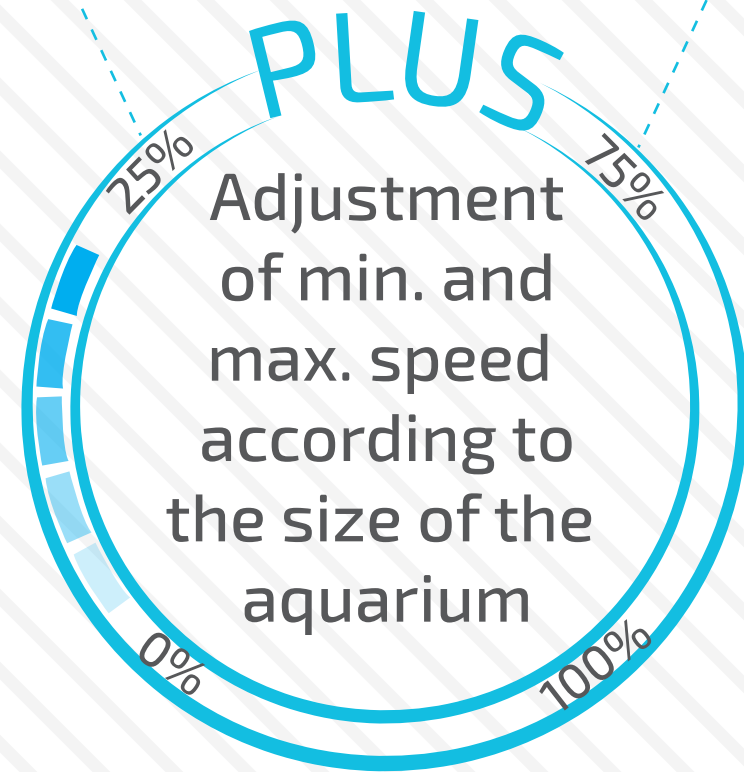

# SICCE SMART CONNECTION SYSTEM



Lab tests



Feeder



Web Cam



Stream Pump

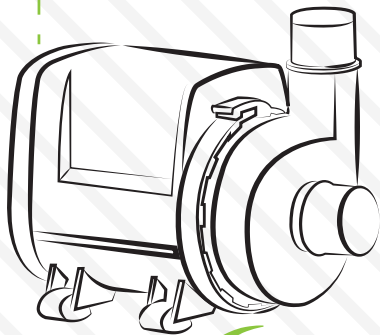

Dosing pump

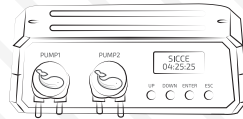

Lamp



Power Strip

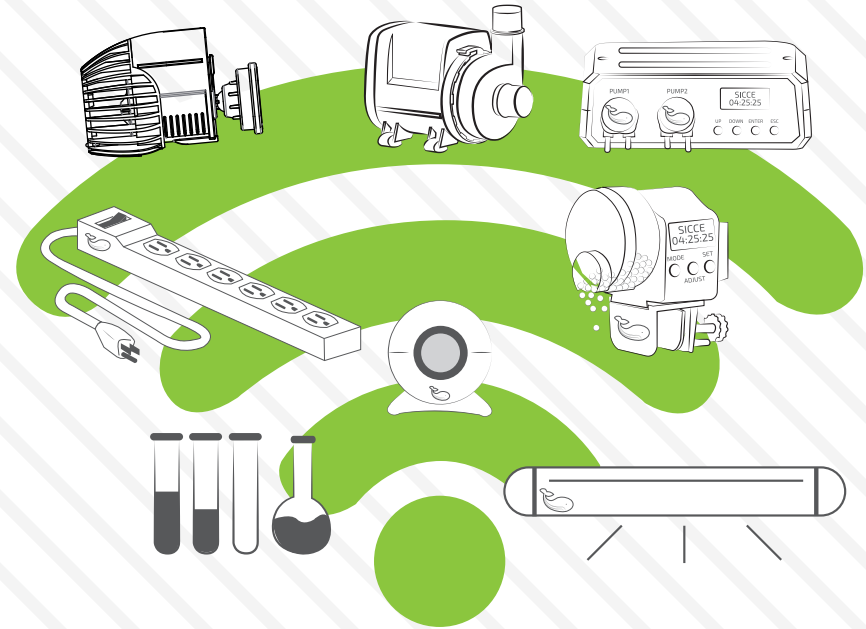
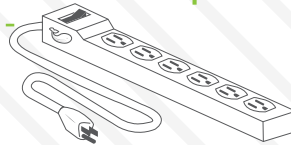

SYNCRASmart

# CLOSED LOOP MODE

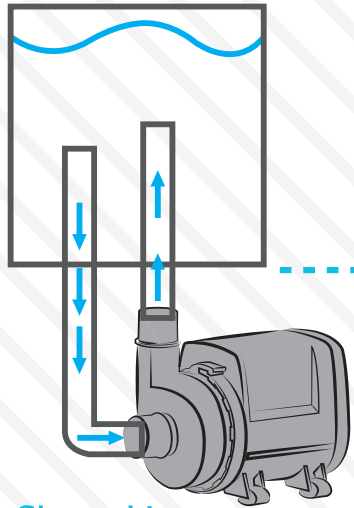

Closed Loop

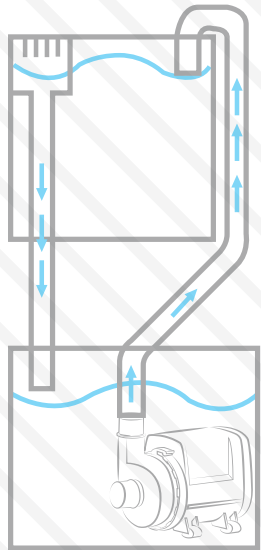

Return Pump

Down max to 20-30%  
from highest speed

Down max to 40-50%  
from highest speed

Down max to 60-70%  
from highest speed

Down max to 30-40%  
from highest speed

Down max to 50-60%  
from highest speed

Custom with SICCE  
CONTRALL  
APP. download

## CLOSED LOOP MODE



Lagoonal  
Ripple



Sharp  
Break



Reef  
Crest



Slow  
Current



Fast  
Current

